



QLSP06RGBXWAJ
(3030RGBW HP LED)



Product Outline:

This is a small package with ceramic substrate for multi-color high power LED, that provides high lumen output in the 3030 package. Creating a small optical light source because of the compact design it's ideal for color mixing applications

Features:

- Multi-Color LED, Red/Green/Blue/White LED
- Ceramic substrate
- High brightness output @ 350mA,
- Package Dimension = 3.0mmX3.0mmX1.8mm
- RoHS compliant
- Custom Bin available upon special request
- View angel >120°

Application:

- Entertainment lighting
- Architecture Lighting
- Garden Lighting
- Indoor and Outdoor Lighting
- Entertainment lighting.

Compliance and Certification:



Mechanical Property: (Dimension)

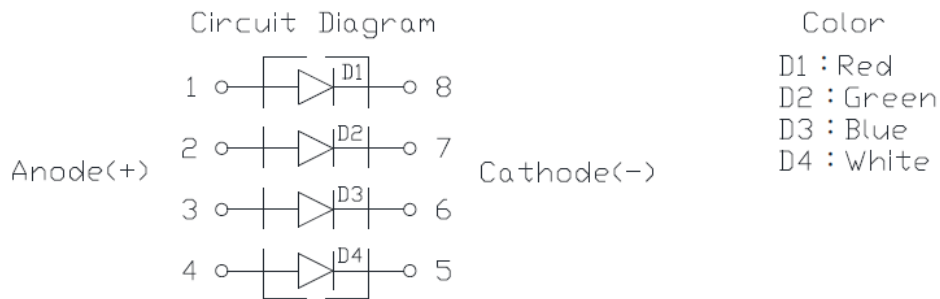
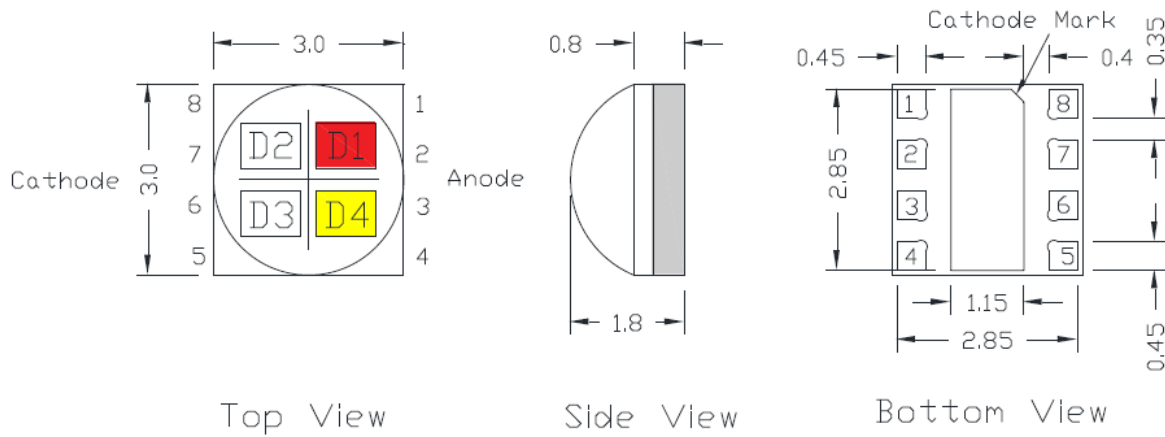

- * All dimensions are in millimeter and tolerances are $\pm 0.10\text{mm}$.
- * Please do not bend the leads of the LED, otherwise it will damage the LED.
- * Please do not use a force of over 0.3kgf impact or pressure on the lens of the LED, it will cause a failure.

Recommended Solder footprint:

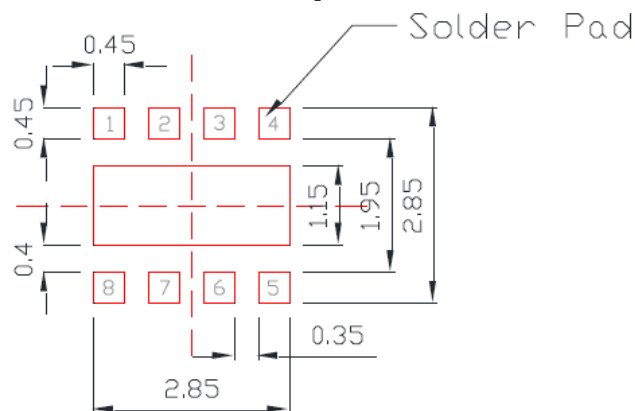

- * All dimensions are in millimeters.
- * The LEDs is designed to be reflow soldered on to a PCB. IF dip soldered that QL cannot guarantee its reliability.
- * Reflow soldering must not be performed more than twice.



Characteristics

■ Absolute Maximum Ratings

(Ta=25°C)

Parameter	Symbol	Rating	Unit
DC Forward Current	If	400	mA
Leakage Current (5V)	Ir	10	μ A
Total Power Dissipation	Pd	5000	mW
Pulse Forward Current	Ifp	500	mA
LED Junction Temperature	TJ	120	°C
Storage Temperature	Tstg	-40 ~ 85	°C
Operation Temperature	Topr	-40 ~ 120	°C
Soldering Temperature	Tsol	260 < 10 sec	°C

- (1) Proper current rating must be observed to maintain junction temperature below maximum at all time
 (2) IFP Condition: Duty 1/10, Pulse within 10msec

■ Electrical / Optical Characteristic

(Ta=25 oC)

Parameter	Symbol	Condition	Min.	Typ.	Max.	Unit
Red	Vf	350mA	2.0		2.6	V
Green			2.8		3.6	V
Blue			2.8		3.6	V
White			2.8		3.6	V
View Angle	θ			120		deg

- (1) Tolerance of measurement: VF=+/- 0.1V



■ Specification

Product	Color	Current	Vf(V) Typ.	Wd / CCT (nm)	Flux ΦV(lm)	
					Min.	Typ.
QLSP06RGBXWAJ	Red	350mA	2.2	620~630	45	55
	Green		3.2	520~530	90	110
	Blue		3.2	450~460	19	22
	White		3.2	4480~6970K	80	105

*Tolerance = +/- 10%

■ Groups

Dominant Wavelength

Wd (nm)				
Color	Code name	Min.	Max.	Condition
Red	A82	620	630	350mA
Green	DN2	520	530	
Blue	DA2	450	460	

Measurement tolerance is +/- 1nm

Forward Voltage (V_F) Bin:

VF Rank				
Color	Code name	Low	High	Condition
Red	R6	2.0	2.6	350mA
Green	Z8	2.8	3.6	
Blue	Z8	2.8	3.6	
White	Z8	2.8	3.6	

The forward voltage tolerance is ± 0.1V



Luminous Flux Bin:

Flux Φ_V (lm)				
Color	Code name	Low	High	Condition
Red	A	45	58	350mA
	B	58	75	
Green	A	90	115	
	B	115	147	
Blue	A	19	25	
	B	25	33	
White	A	80	105	
	B	105	130	

luminous flux tolerance is $\pm 7\%$

■ **White Binning**
Cold White Binning:

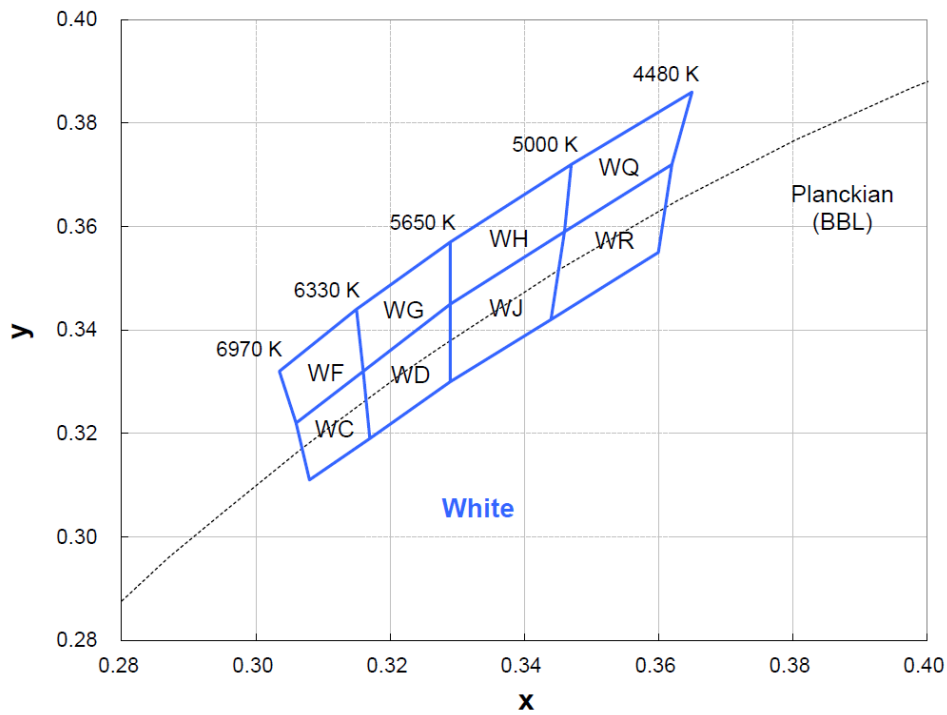

Characteristic Curves

(1) Color Spectrum

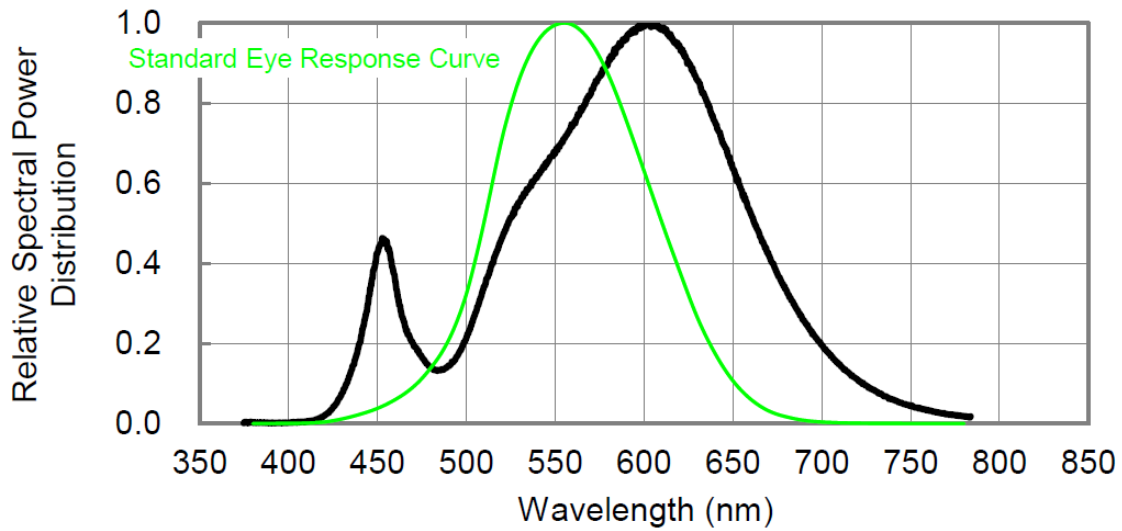
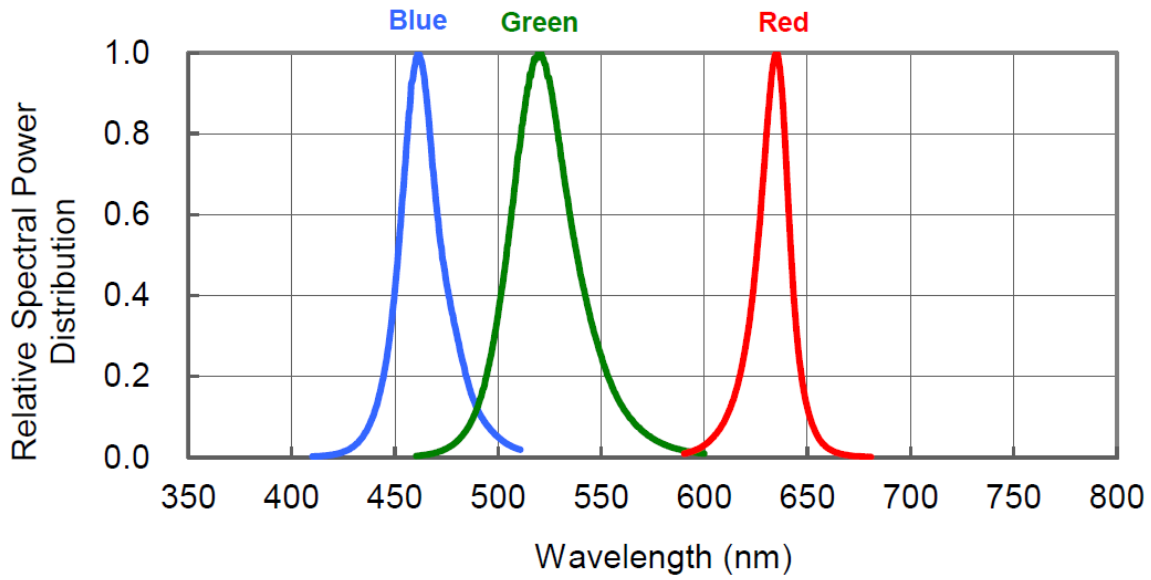

(2). Typical Representative Spatial Radiation Pattern

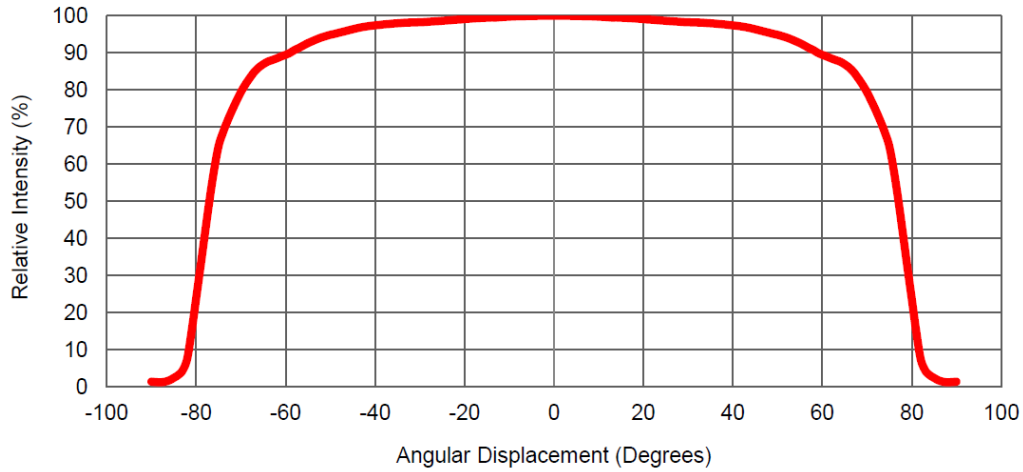

(3). Forward Current vs Relative Luminous Flux

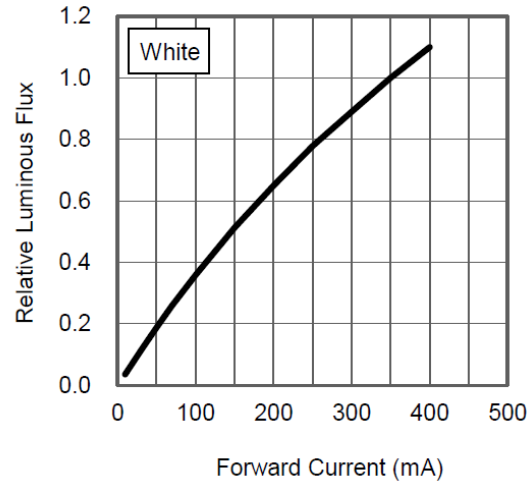
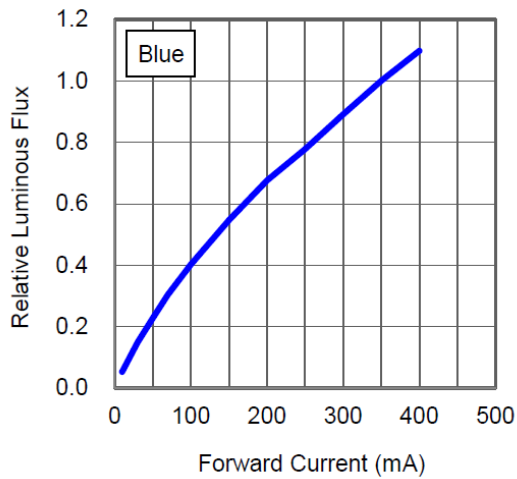
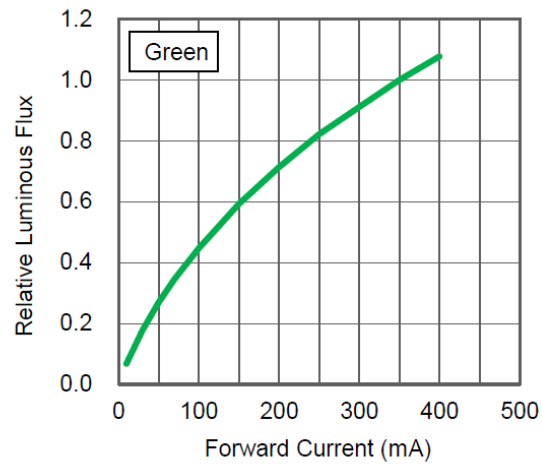
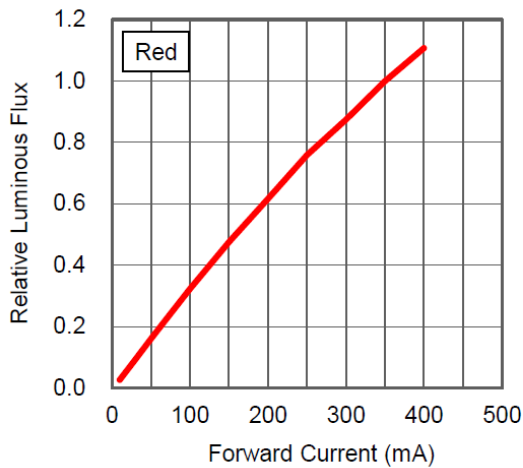

(4). Forward Current vs Forward Voltage

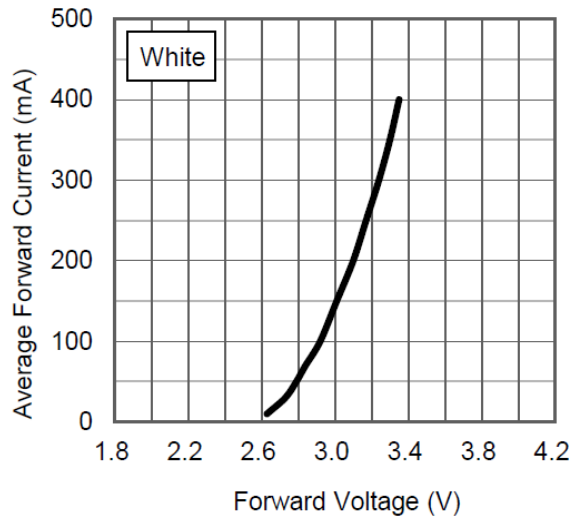
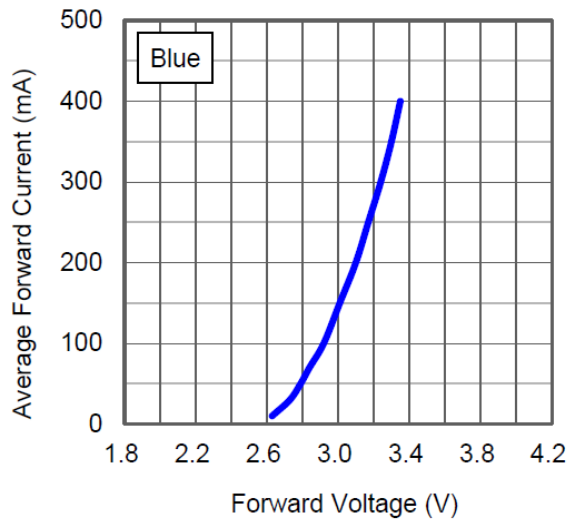
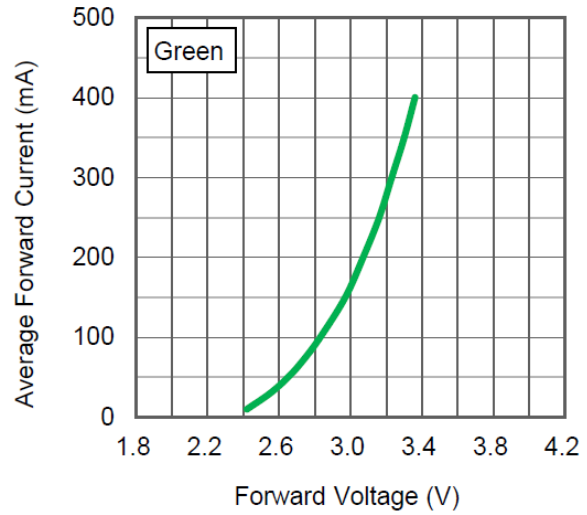
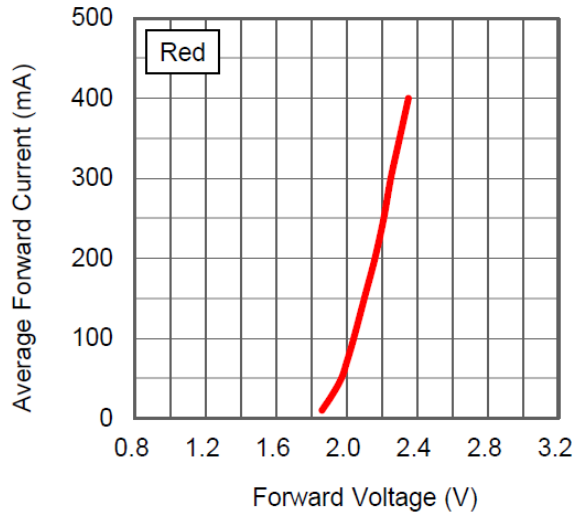

(5). Relative Light Output vs. Junction Temperature

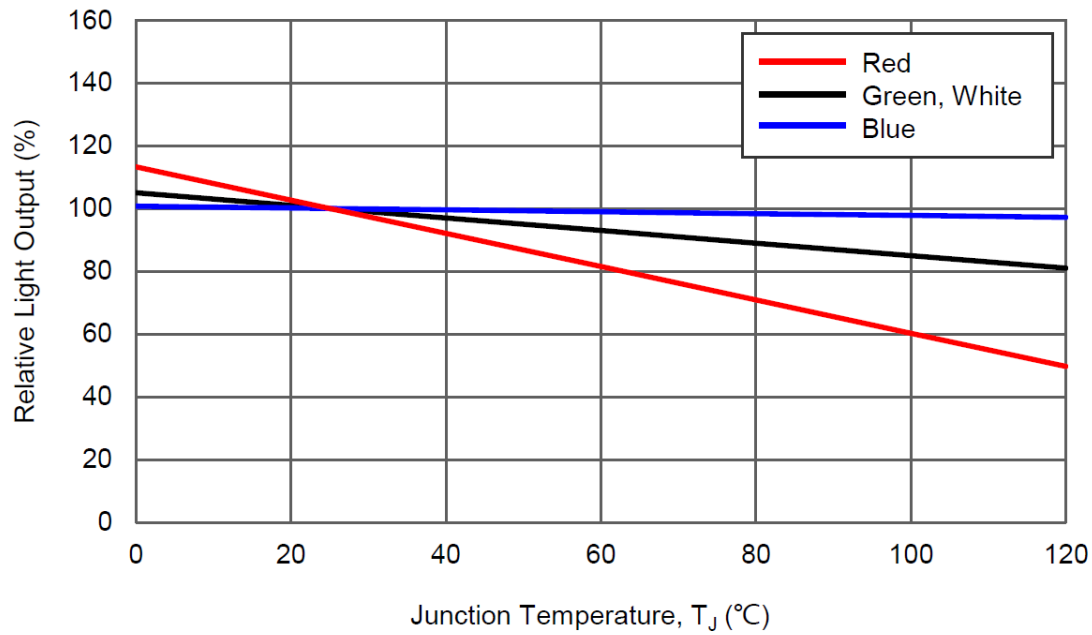

(6). Board Temperature vs. Maximum Forward Current

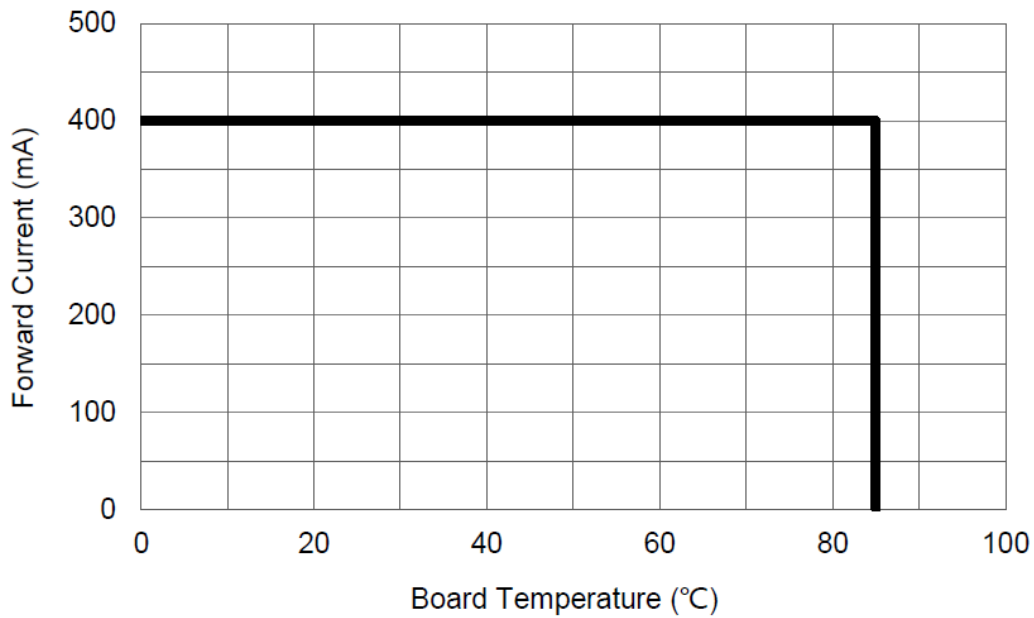

■ Reliability test:

No	Item	Condition	Time/Cycle	Sample size
1	Steady State Operating Life of Room Temperature	25°C Operating	1000 Hrs	20 pcs
2	Steady State Operating Life of Low Temperature -40°C	-40°C Operating	1000 Hrs	20 pcs
3	Steady State Operating Life of Low Temperature 60°C	60°C Operating	1000 Hrs	20 pcs
4	Steady State Operating Life of Low Temperature 85°C	85°C Operating	1000 Hrs	20 pcs
5	Low temperature storage -40°C	-40°C Storage	1000 Hrs	20 pcs
6	High temperature storage 100°C	100°C Storage	1000 Hrs	20 pcs
7	Steady State Operating Life of High Humidity Heat 60°C 90%	60°C/90% Operating	1000 Hrs	20 pcs
8	Steady State Pulse Operating Life Condition	25°C 10Hz duty=1/10 Operating	200 Cycle	20 pcs
9	Resistance to soldering heat on PCB (JEDEC MSL3)	pre-store@60°C, 60%RH for 52hrs Tsltd max.=260 10sec	3 Times	20 pcs
10	Heat Cycle Test (JEDEC MRC)	25°C~65°C~-10°C, 90%RH, 24hr/1cycle	10 Cycle	20 pcs
11	Thermal shock	-40°C/ 20minr~ 5minr~100°C /20min	300 Cycle	20 pcs

■ Judgment Criteria:

Item	Symbol	Test Condition	Judgment Criteria
Forward Voltage	Vf	350 mA	$\Delta Vf < 10\%$
Luminous Flux	Iv	350 mA	$\Delta Iv < 30\%$



Solder Profile:

-The recommended reflow soldering profile is as follows (temperatures indicated are as measured on the surface of the LED resin):

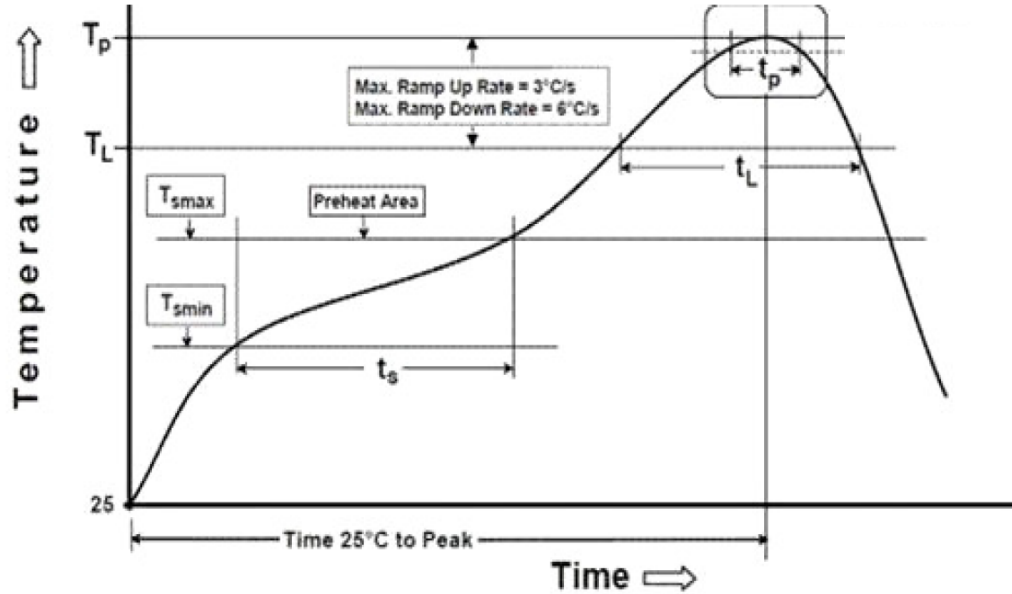

Profile Feature	Sn-Pb Eutectic Assembly	Pb-Free Assembly
Temperature Min(T_{smin})	100°C	150°C
Temperature Max(T_{smax})	150°C	200°C
Time(t_a) from (T_{smin} to T_{smax})	60-120 seconds	60-120 seconds
Ramp-up rate(T_L to T_p)	3°C/second max.	3°C/second max.
Liquidous Temperature(T_L)	183°C	217°C
Time(t_L) maintained above T_L	60-150 seconds	60-150 seconds
Peak package body temperature(T_p)	235°C	260°C
Time within 5°C of Actual Peak temperature (t_p)	20seconds*	30 seconds*
Ramp-down rate(T_p to T_L)	6°C/second max.	6°C/second max.
Time 25°C to peak temperature	6 minutes max.	8 minutes max.

* Tolerance for peak profile temperature (T_p) is defined as a supplier minimum and a user maximum.

Note:

1. The recommended reflow temperature is 230°C, the maximum soldering temperature should be limited to 240°C
2. Do not stress the silicone resin while it is exposed to high temperature.
3. The number of reflow process should not exceed 3 times



Taping & Packing:

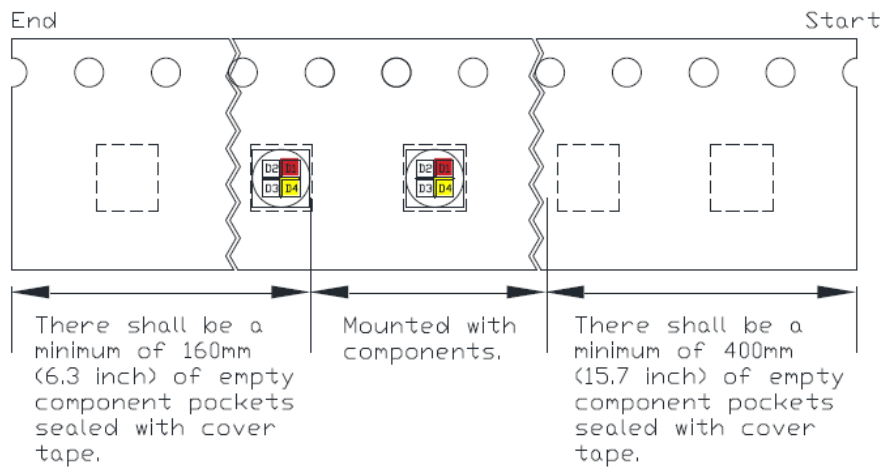
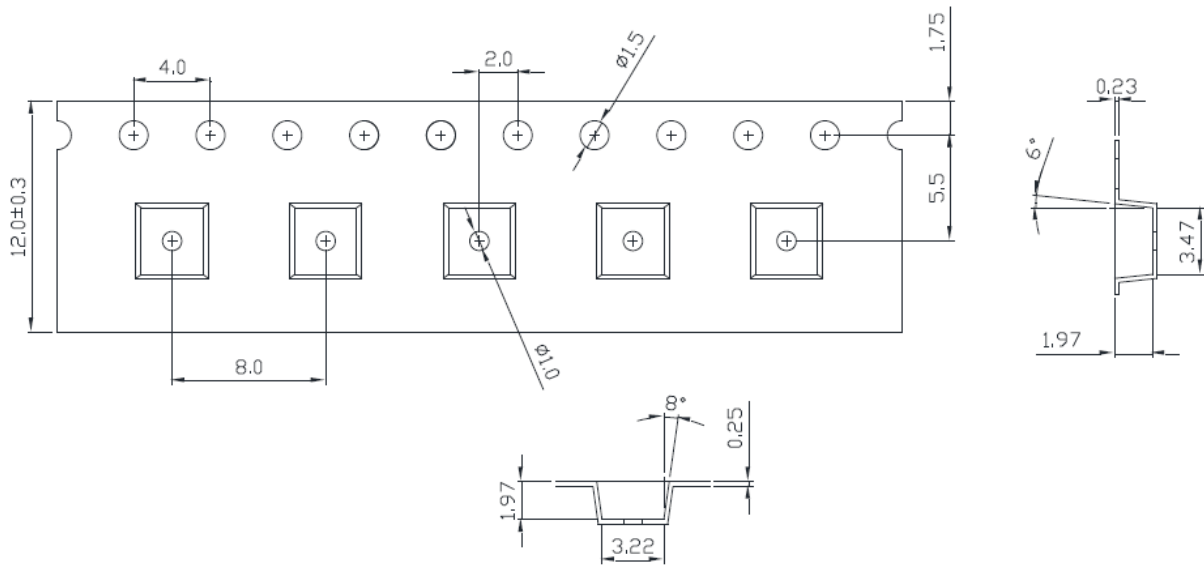

Unit : mm

Notes:

1. Drawing not to scale.
2. All dimensions are in millimeters.
3. Unless otherwise indicated, tolerances are $\pm 0.10\text{mm}$.



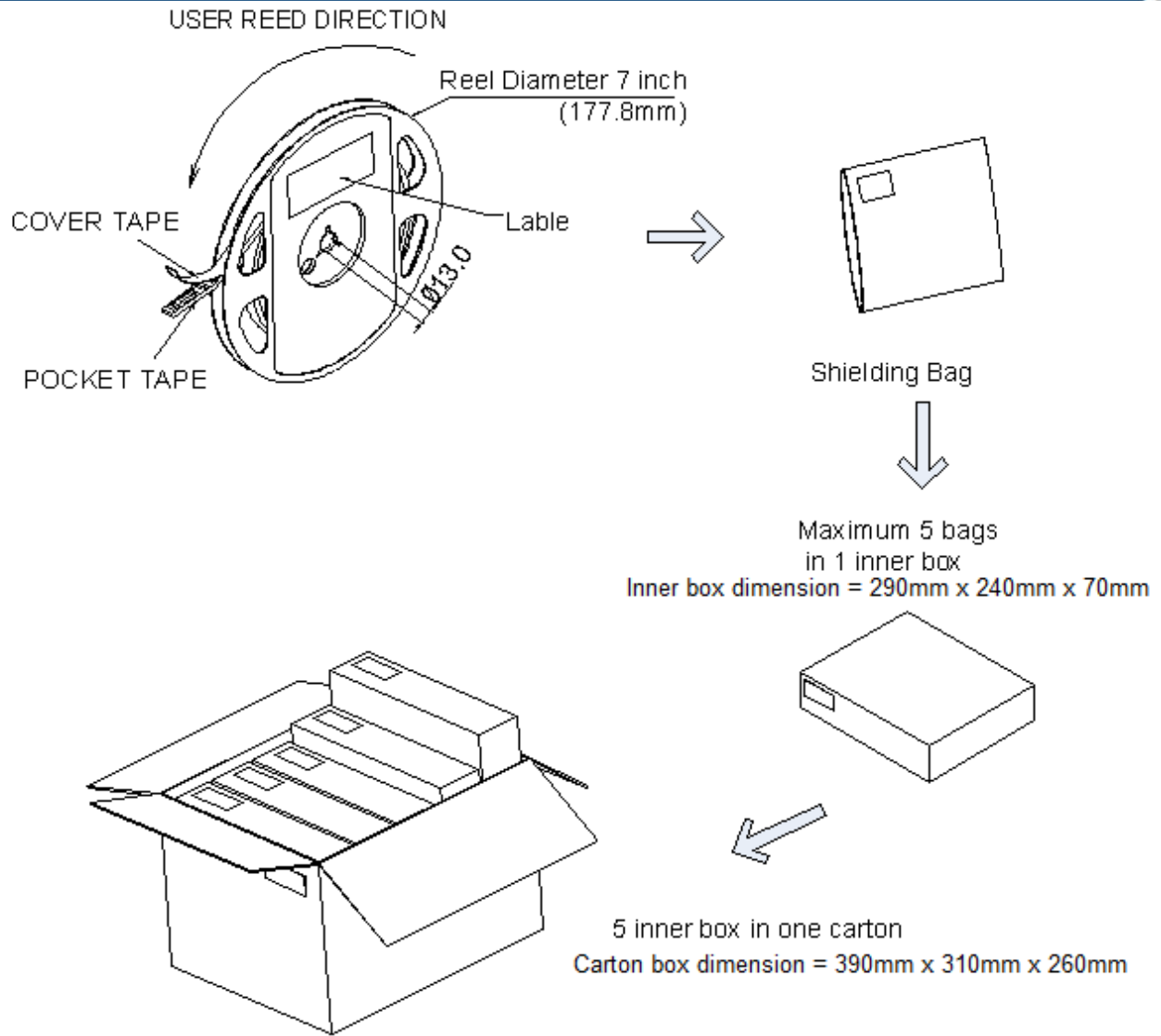



Labeling

Quantity: XXXX



Quelighting P/N: XXXXXX

Lot number: XXXXX

Iv Bin: XX

Color Bin: XX

Vf Bin: XX

Date Code: XXXX

Ordering Information:

Part #	Multiple Quantities	Quantity per Reel
QLSP06RGBXWAJ		250,500,1000 pcs



Revision History:

Revision Date:	Changes:	Version #:
11-26-2020	Initial release	1.0

