

### SPECIFICATIONS

<b>CUSTOMER</b>	:	<b>CBE005</b>
<b>SAMPLE CODE</b>	:	<b>SNA800480T013IHC09</b>
<b>MASS PRODUCTION CODE</b>	:	<b>HNA800480T013IHC09</b>
<b>SAMPLE VERSION</b>	:	<b>01</b>
<b>SPECIFICATIONS EDITION</b>	:	<b>002</b>
<b>DRAWING NO. (Ver.)</b>	:	<b>LMD- HNA800480T013IHC09 (Ver.001)</b>
<b>PACKAGING NO. (Ver.)</b>	:	<b>PKG- HNA800480T013IHC09 (Ver.001)</b>

**Customer Approved**

---

**Date:**

Approved	Checked	Designer
林裘中 <b>Daniel Lin</b>	呂清溪 <b>Marc Lu</b>	廖志豪 <b>Rex Liao</b>

- Preliminary specification for design input
- Specification for sample approval

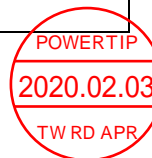

### POWER TIP TECH. CORP.

<b>Headquarters:</b> No.8, 6 <sup>th</sup> Road, Taichung Industrial Park, Taichung, Taiwan 台中市 407 工業區六路 8 號	TEL: 886-4-2355-8168 FAX: 886-4-2355-8166	E-mail: <a href="mailto:sales@powertip.com.tw">sales@powertip.com.tw</a> Http://www.powertip.com.tw
---	--	--

## History of Version

Date (mm / dd / yyyy)	Ver.	Edi.	Description	Page	Design by
11/25/2019	01	001	New Drawing.	-	Rex
02/03/2020	01	002	New Sample.	-	Rex

## Contents

### 1. SPECIFICATIONS

- 1.1 Features
- 1.2 Mechanical Specifications
- 1.3 Absolute Maximum Ratings
- 1.4 DC Electrical Characteristics
- 1.5 Optical Characteristics

### 2. MODULE STRUCTURE

- 2.1 Counter Drawing
- 2.2 Interface Pin Description

### 3. QUALITY ASSURANCE SYSTEM

- 3.1 Quality Assurance Flow Chart

### 4. RELIABILITY TEST

- 4.1 Reliability Test Condition

### 5. PRECAUTION RELATING PRODUCT HANDLING

- 5.1 Safety
- 5.2 Handling
- 5.3 Storage
- 5.4 Terms of Warranty

Appendix : 1.LCM Drawing

## 1. SPECIFICATIONS

### 1.1 Features

#### Hardware

CPU	RISC Processor	N32926 (ARM926EJ-S) 64MB DDR2 SDRAM
Memory	On Board Flash	1Gb NAND Flash
	External Storage *	1x Micro SD (max. 32G)
I/O	USB	1x USB2.0 Device
	Serial	1 x UART

#### LCD Display

Item	Standard Value
Display Resolution	800 * 3 (RGB) * 480 Dots
LCD Type	a-Si TFT , Normally white , Transmissive type
Touch Panel	Projected Capacitive Touch
Screen size(inch)	7.0 inch
Color configuration	RGB Vertical Strip
Backlight Type	White LED B/L
ROHS	<p>THIS PRODUCT CONFORMS THE ROHS OF PTC</p> <p>Detail information please refer website :</p> <p><a href="http://www.powertip.com.tw/news_detail.php?Key=1&amp;cID=1">http://www.powertip.com.tw/news_detail.php?Key=1&amp;cID=1</a></p>

#### Note:

1. Support PWM Signal Output. (5kHz, Duty Cycle: 256 Step)
2. Support JPEG Codec.
3. Support H.264 & MJPEG Codec
4. Support Video Data Processor (VPE)
5. Support RTC

**PS:**

This product built-in Powertip communication protocol system firmware. It manipulates the GUI contents that generated by Powertip Graphic Editor software.

**1.2 Mechanical Specifications**

Item	Standard Value	Unit
Outline Dimension	186.8(W) x 110.56(L) x 16.5 max. (H)	
Active Area	154.08 (W) x 85.92(L)	mm

Note : For detailed information please refer to drawing

### 1.3 Absolute Maximum Ratings

Item	Symbol	Condition	Min.	Max.	Unit	Remark
Power Supply	V <sub>IN</sub>	GND=0	-0.3	6.0	V	-
Operating Temperature	T <sub>OP</sub> (T <sub>s</sub> )	Note 1	-20	70	°C	
Storage Temperature	T <sub>ST</sub> (T <sub>a</sub> )	Note 2	-30	80	°C	

The absolute maximum rating values of this product are not allowed to be exceeded at any times. Should a module be used with any of the absolute maximum ratings exceeded, the characteristics of the module may not be recovered, or in an extreme case, the product may be permanently destroyed.

Note 1 : T<sub>s</sub> is the temperature of panel's surface.

Note 2 : T<sub>a</sub> is the ambient temperature of samples.

### 1.4 DC Electrical Characteristics

T<sub>a</sub> = 25°C

Item	Symbol	Condition	Min.	Typ.	Max.	Unit
Power Supply Voltage	V <sub>IN</sub>	-	4.8	5.0	5.5	V
Power Supply Voltage of RTC	V <sub>BAT</sub>	-	2.0	-	3.6	V
Power Supply Current *1	I <sub>IN</sub>	V <sub>IN</sub> = 5.0V	-	1.5	2.0	A
Power Consumption of System	P <sub>IN</sub>	V <sub>IN</sub> = 5.0V	-	-	10.0	W
IO High-Level input voltage	V <sub>IH</sub>	-	2.0	-	V <sub>3V3</sub> +0.3	V
IO Low-Level input voltage	V <sub>IL</sub>	-	-	-	0.8	V
IO High-Level output voltage	V <sub>OH</sub>	-	2.4	-	-	V
IO Low-Level output voltage	V <sub>OL</sub>	-	-	-	0.4	V

## 1.5 Optical Characteristics

Ta=25°C

Item		Symbol	Condition	Min.	Typ.	Max.	unit	-
Response time	Tr+Tf	25°C	-	-	25	50	ms	-
Viewing angle	Top	$\theta Y+$	CR $\geq$ 10		60	-	Deg.	Note 4
	Bottom	$\theta Y-$			60	-		
	Left	$\theta X-$			60	-		
	Right	$\theta X+$			60	-		
Contrast ratio		CR		500	600	-	-	Note 3
Color of CIE Coordinate (With B/L & T/P)	White	X	(Ta = 25°C $\theta X, \theta Y = 0^\circ$ )	0.23	0.28	0.33	-	Note1
		Y		0.27	0.32	0.37		
	Red	X		0.52	0.57	0.62		
		Y		0.31	0.36	0.41		
	Green	X		0.29	0.34	0.39		
		Y		0.55	0.60	0.65		
	Blue	X		0.09	0.14	0.19		
		Y		0.02	0.07	0.12		
Average Brightness Pattern=white display (With T/P)*1		IV	PWM="High" (Duty=100%)	680	850	-	cd/m2	Note1
Uniformity (With T/P)*2		$\Delta B$	PWM="High" (Duty=100%)	70	-	-	%	Note1

Note 1:

\*1 :  $\Delta B = B(\text{min}) / B(\text{max}) * 100\%$

\*2 : Measurement Condition for Optical Characteristics:

a : Environment:  $25^{\circ}\text{C} \pm 5^{\circ}\text{C}$  /  $60 \pm 20\%$  R.H , no wind , dark room below 10 Lux at typical lamp current and typical operating frequency.

b : Measurement Distance:  $500 \pm 50$  mm , ( $\theta = 0^{\circ}$ )

c : Equipment: TOPCON BM-7 fast , (field  $1^{\circ}$ ) , after 10 minutes operation.

d : The uncertainty of the C.I.E coordinate measurement  $\pm 0.01$  , Average Brightness  $\pm 4\%$

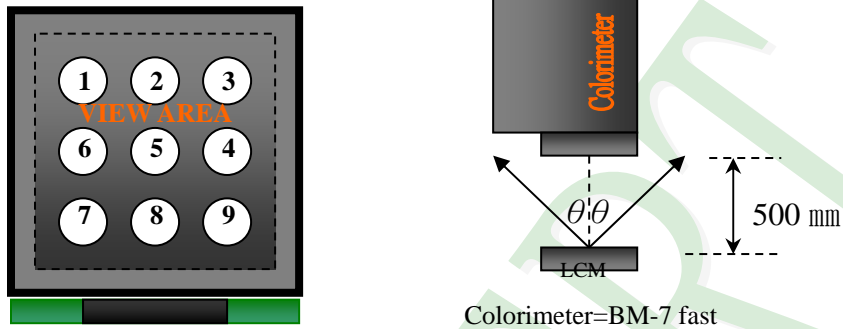

To be measured at the center area of panel with a viewing cone of  $1^{\circ}$  by Topcon luminance meter BM-7, after 10 minutes operation (module)

Note2: Definition of response time:

The output signals of photo detector are measured when the input signals are changed from "black" to "white"(falling time) and from "white" to "black"(rising time), respectively. The response time is defined as the time interval between the 10% and 90% of Amplitudes.

Refer to figure as below:

Normally White





### Normally Black

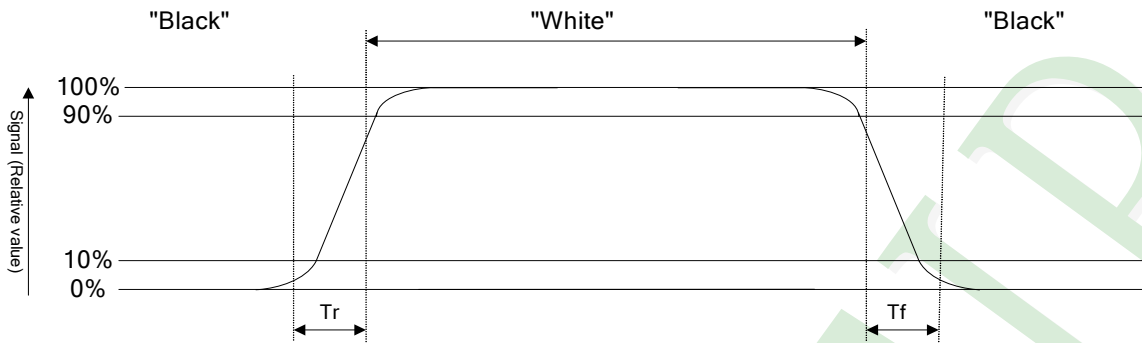

Note3: Definition of contrast ratio:

Contrast ratio is calculated with the following formula

$$\text{Contrast ratio (CR)} = \frac{\text{Photo detector output when LCD is at "White" state}}{\text{Photo detector output when LCD is at "Black" state}}$$

Note4: Definition of viewing angle:

Refer to figure as below:

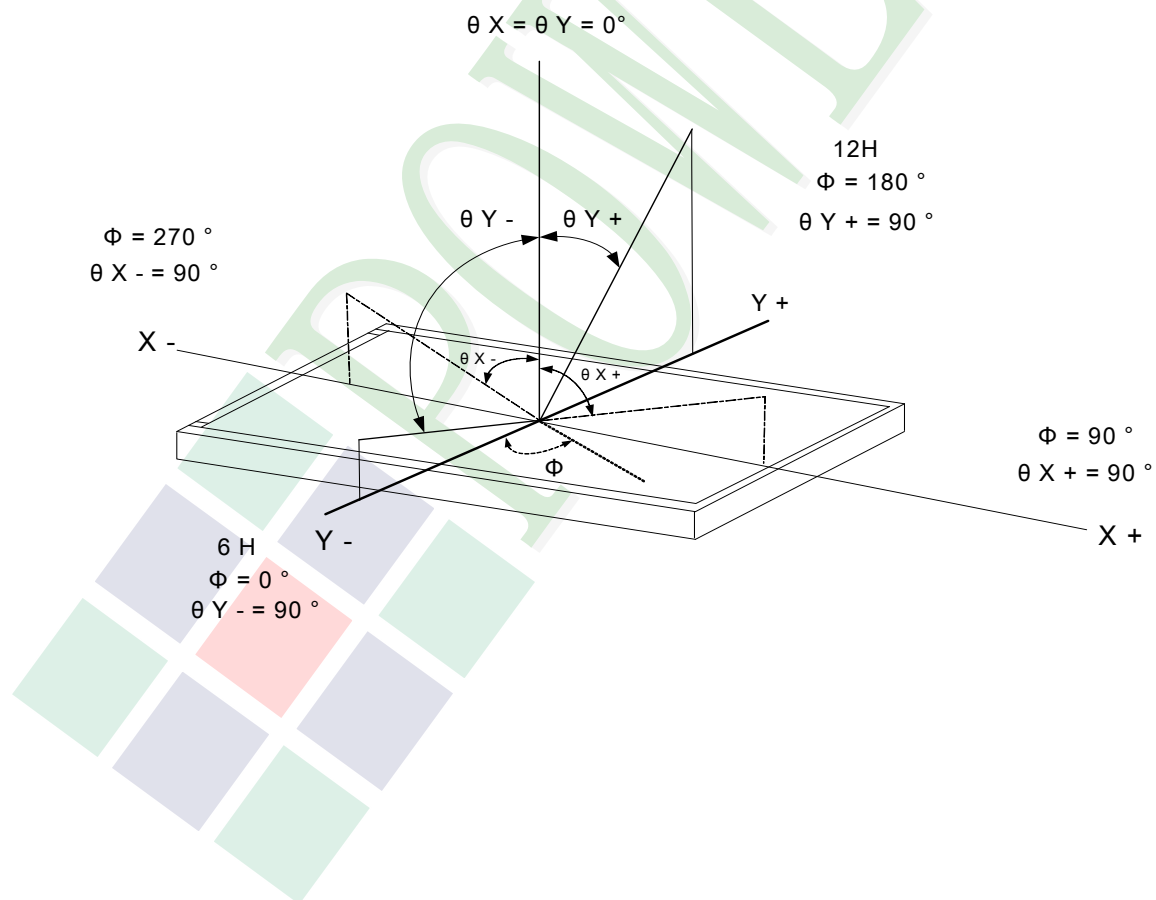

## 2. MODULE STRUCTURE

### 2.1 Counter Drawing

#### 2.1.1 Mechanical Diagram

\* See Appendix

#### 2.1.2 Block Diagram

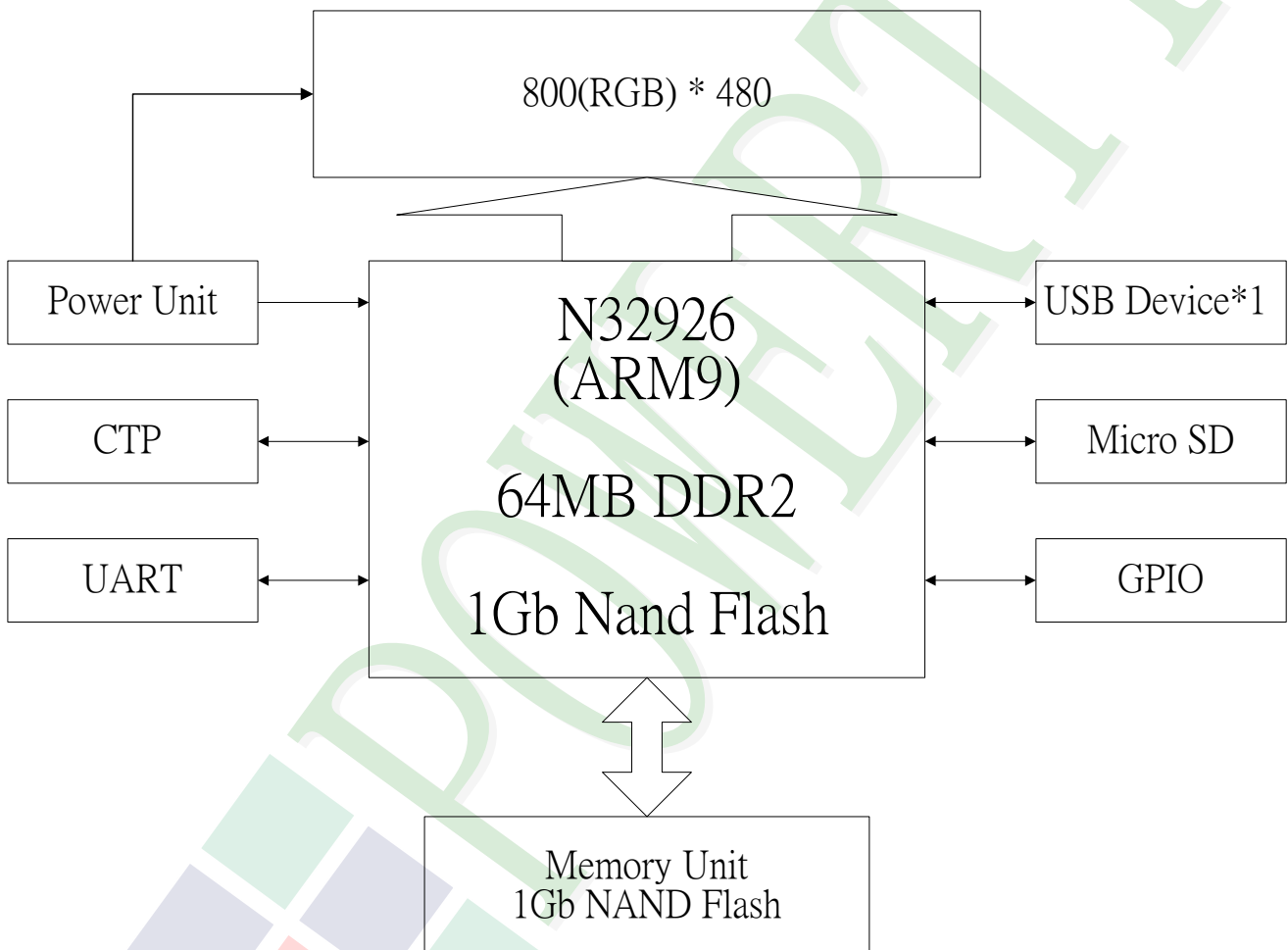

## 2.2 Interface Pin Description

### J8 --- I/O

Pin No.	Symbol	Type	DESCRIPTION
1	GND	P	Power ground.
2	GPG9	IO	General Purpose I/O, Port G[9].
3	GPG8	IO	General Purpose I/O, Port G[8].
4	NC	-	Not Used.
5	GND	P	Power ground.
6	NC	-	Not Used.
7	GND	P	Power ground.
8	NC	-	Not Used.
9	GND	P	Power ground.
10	GPG2	IO	General Purpose I/O, Port G[2].
11	GND	P	Power ground.
12	GPG4	IO	General Purpose I/O, Port G[4].
13	GPG5	IO	General Purpose I/O, Port G[5].
14	GND	P	Power ground.
15	GPG3	IO	General Purpose I/O, Port G[3].
16	GND	P	Power ground.
17	HPOUT_L	A	Connect to N32926 pin 102.
18	HPOUT_R	A	Connect to N32926 pin 101.
19	GPG7	IO	General Purpose I/O, Port G[7].
20	GPA11	IO	General Purpose I/O, Port A[11].
21	GND	P	Power ground.
22	RESETn	I	System reset signal input, active low.

Pin No.	Symbol	Type	Function
23	UART_RXD	I	UART port, receiver signal.
24	UART_TXD	O	UART port, transmitter signal.
25	GND	P	Power ground.
26	VIN	P	DC 5.0V Power Supply.
27	VIN	P	DC 5.0V Power Supply.
28	NC	-	Not Used.
29	NC	-	Not Used.
30	GND	P	Power ground.

### J9 --- USB 2.0 Device Micro USB type

Pin No.	Symbol	Type	DESCRIPTION
1	VUSB5V	P	USB +5.0V.
2	D-	DS	Data – (Data M).
3	D+	DS	Data + (Data P).
4	NC	-	Not Used.
5	GND	P	Ground.

### J11 --- RTC POWER

Pin No.	Symbol	Type	Function
1	VBAT	P	Power Supply for RTC.
2	GND	P	Ground.

### 3. QUALITY ASSURANCE SYSTEM

#### 3.1 Quality Assurance Flow Chart

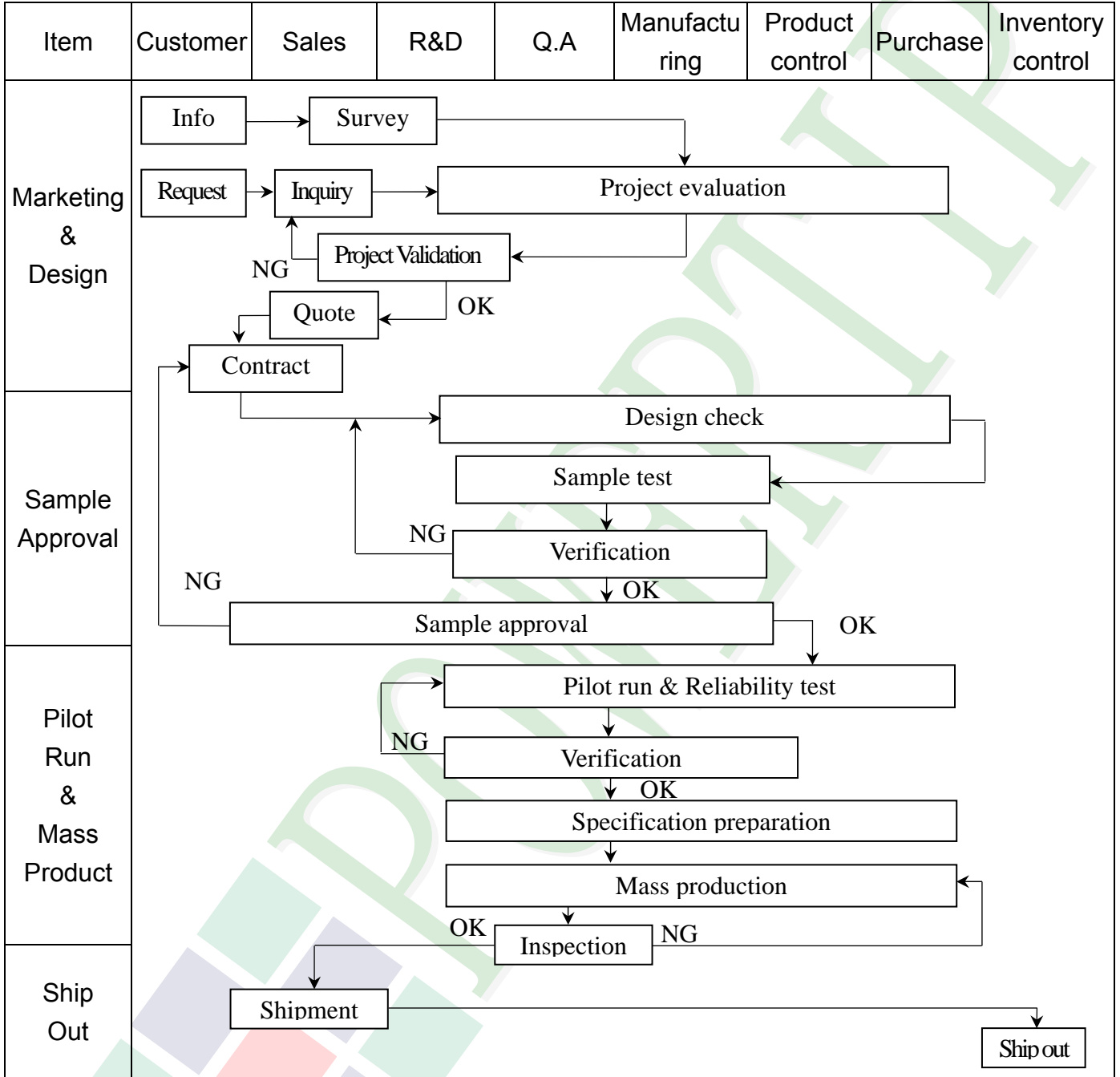

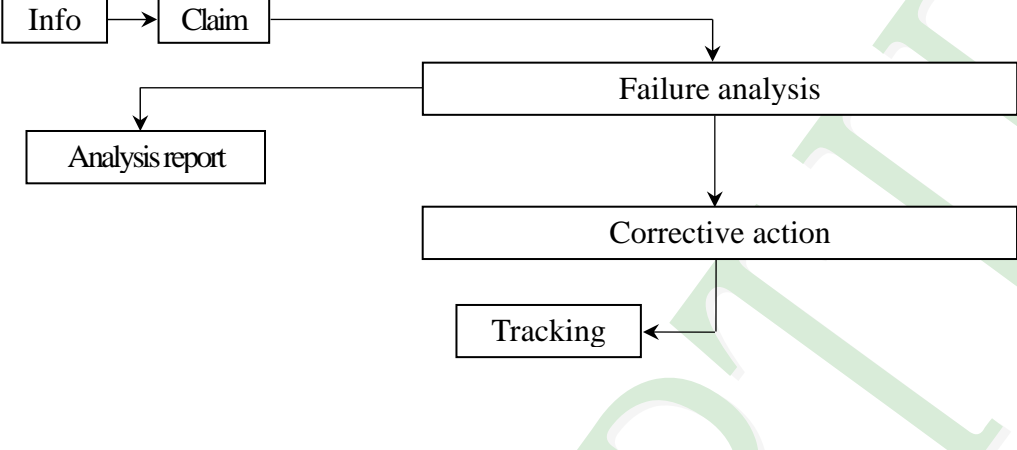
Item	Customer	Sales	R&D	Q.A	Manufacturing	Product control	Purchase	Inventory control
Sales Service	 <pre> graph TD     Info[Info] --&gt; Claim[Claim]     Claim --&gt; Failure[Failure analysis]     Failure --&gt; Report[Analysis report]     Failure --&gt; Action[Corrective action]     Action --&gt; Tracking[Tracking]           </pre>							
Q.A Activity	1. ISO 9001 Maintenance Activities 3. Equipment calibration 5. Standardization Management				2. Process improvement proposal 4. Education And Training Activities			

## 4. RELIABILITY TEST

### 4.1 Reliability Test Condition

NO.	TEST ITEM	TEST CONDITION										
1	High Temperature Storage Test	Keep in +70 ±2°C 240 hrs Surrounding temperature, then storage at normal condition 4hrs.										
2	Low Temperature Storage Test	Keep in -20 ±2°C 240 hrs Surrounding temperature, then storage at normal condition 4hrs.										
3	High Temperature / High Humidity Storage Test	Keep in +60°C / 90% R.H duration for 240 hrs Surrounding temperature, then storage at normal condition 4hrs. (Excluding the polarizer)										
4	Temperature Cycling Storage Test	$  \begin{array}{ccccccc}  -20^{\circ}\text{C} & \rightarrow & +25^{\circ}\text{C} & \rightarrow & +70^{\circ}\text{C} & \rightarrow & +25^{\circ}\text{C} \\  (30\text{mins}) & & (5\text{mins}) & & (30\text{mins}) & & (5\text{mins}) \\  \leftarrow & & & & & & \rightarrow \\  & & & & 10 \text{ Cycle} & &   \end{array}  $ Surrounding temperature, then storage at normal condition 4hrs.										
5	Vibration Test (Packaged)	<ol style="list-style-type: none"> <li>Sine wave 10~55 Hz frequency (1 min)</li> <li>The amplitude of vibration :1.5 mm</li> <li>Each direction (X、Y、Z) duration for 2 Hrs</li> </ol>										
6	Drop Test (Packaged)	<table border="1"> <thead> <tr> <th>Packing Weight (Kg)</th> <th>Drop Height (cm)</th> </tr> </thead> <tbody> <tr> <td>0 ~ 45.4</td> <td>122</td> </tr> <tr> <td>45.4 ~ 90.8</td> <td>76</td> </tr> <tr> <td>90.8 ~ 454</td> <td>61</td> </tr> <tr> <td>Over 454</td> <td>46</td> </tr> </tbody> </table> Drop direction :※1 corner / 3 edges / 6 sides each 1times	Packing Weight (Kg)	Drop Height (cm)	0 ~ 45.4	122	45.4 ~ 90.8	76	90.8 ~ 454	61	Over 454	46
Packing Weight (Kg)	Drop Height (cm)											
0 ~ 45.4	122											
45.4 ~ 90.8	76											
90.8 ~ 454	61											
Over 454	46											

## 5. PRECAUTION RELATING PRODUCT HANDLING

### 5.1 SAFETY

- 5.1.1 If the LCD panel breaks, be careful not to get the liquid crystal to touch your skin.
- 5.1.2 If the liquid crystal touches your skin or clothes, please wash it off immediately by using soap and water.

### 5.2 HANDLING

- 5.2.1 Avoid any strong mechanical shock which can break the glass.
- 5.2.2 Avoid static electricity which can damage the CMOS LSI—When working with the module, be sure to ground your body and any electrical equipment you may be using.
- 5.2.3 Do not remove the panel or frame from the module.
- 5.2.4 The polarizing plate of the display is very fragile. So, please handle it very carefully, do not touch, push or rub the exposed polarizing with anything harder than an HB pencil lead (glass, tweezers, etc.)
- 5.2.5 Do not wipe the polarizing plate with a dry cloth, as it may easily scratch the surface of plate.
- 5.2.6 Do not touch the display area with bare hands, this will stain the display area.
- 5.2.7 Do not use ketonics solvent & aromatic solvent. Use with a soft cloth soaked with a cleaning naphtha solvent.
- 5.2.8 To control temperature and time of soldering is  $320 \pm 10^{\circ}\text{C}$  and 3-5 sec.
- 5.2.9 To avoid liquid (include organic solvent) stained on LCM
- 5.2.10 Caution!( LCM products with Capacitive Touch Panel)  
Strong EMI-sources such as switch-mode power supplies (SMPS) can lead to touch malfunction (e.g. ghost-touches).  
Therefore, the touch needs to be thoroughly tested inside the target application.
- 5.2.11 CAUTION: Continuously displaying same static image will result in high possibility of image sticking/image burn-in effect due to TFT panel characteristic.

### 5.3 STORAGE

- 5.3.1 Store the panel or module in a dark place where the temperature is  $25^{\circ}\text{C} \pm 5^{\circ}\text{C}$  and the humidity is below 65% RH.
- 5.3.2 Do not place the module near organics solvents or corrosive gases.
- 5.3.3 Do not crush, shake, or jolt the module.

### 5.4 TERMS OF WARRANTY

- 5.4.1 Applicable warrant period The period is within thirteen months since the date of shipping out under normal using and storage conditions.
- 5.4.2 Unaccepted responsibility  
This product has been manufactured to your company's specification as a part for use in your company's general electronic products. It is guaranteed to perform according to delivery specifications. For any other use apart from general electronic equipment, we cannot take responsibility if the product is used in nuclear power control equipment, aerospace equipment, fire and security systems or any other applications in which there is a direct risk to human life and where extremely high levels of reliability are required.



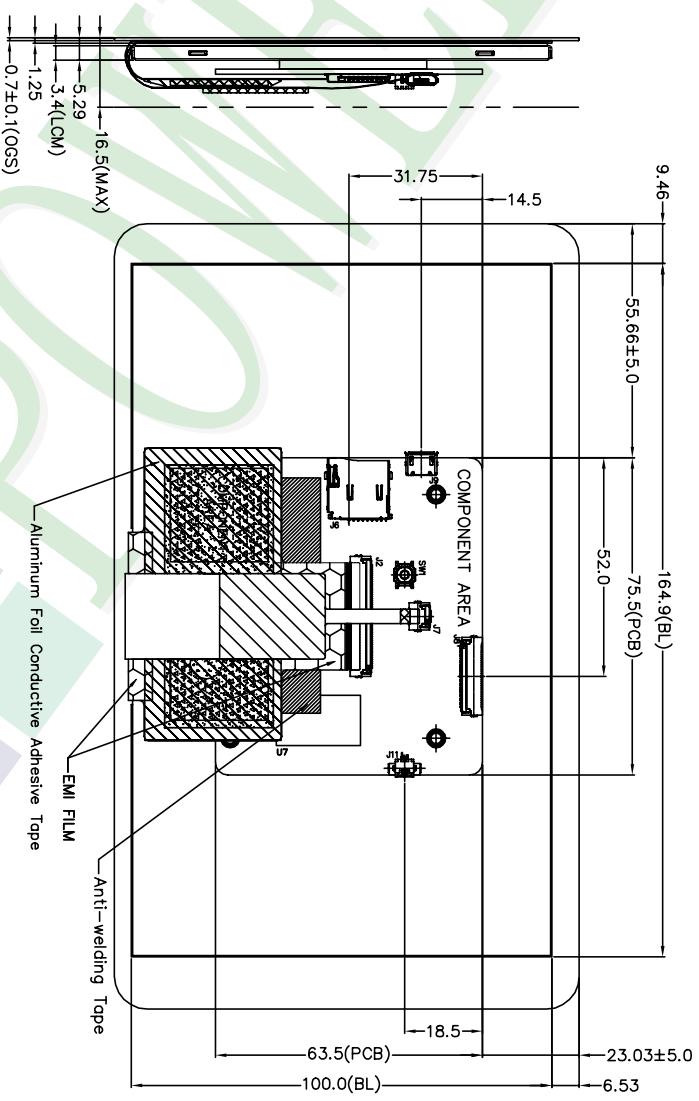
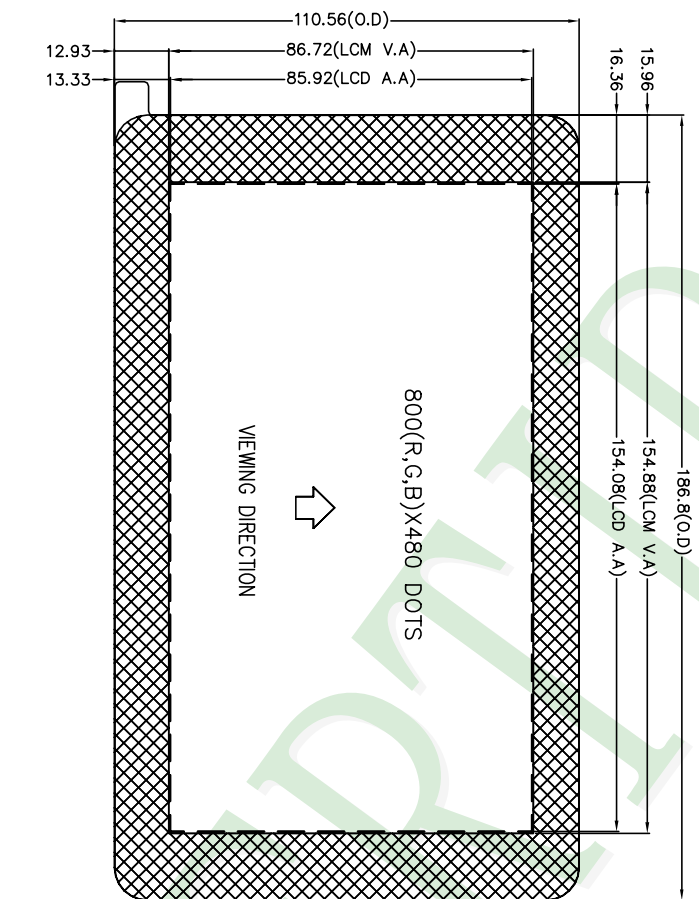

- NOTES:  
1.LCD TYPE: TFT LCD  
2.LCD DISPLAY: POSITIVE/TRANSMISSIVE  
3.The tolerance unless classified ±0.3mm  
4.J6: OUPIN-9004-BZ08C00A03T or Compatible  
5.J8: ORMON XF2W-3015-1A or Compatible  
6.J9: OUPIN-8971-B05C00DPT OR Compatible  
7.J11: Melex 532610271 or Compatible

007					
006					
005					
004					
003					
002					
001	NEW DRAWING	Nini	2019/11/25		
REV	REV BY	REVISER	DATE		

PART NO:	HNA800480T013HC09
DRAWING NAME:	LMD-HNA800480T013HC09
TITLE:	LCD MODULE DRAWING

Design		Nini		Surface		7. Obsolete (mm)		Level	
Check	Marcs	Unit	MM	Material	1 ~ 4	1 ~ 4	-	-	
Approve	Daniel	Scale	1:1	Thickness	16 ~ 63	63 ~ 250	-	-	
		Page	1/1	Quantity	250 ~ 1000		-	-	

久正光電股份有限公司  
POWER TIP TECHNOLOGY CORPORATION

Approve	Check	Contact
Daniel	Marcus	Nini

Documents NO. PKG-HNA800480T013IHC09

## 1. 包裝材料規格表 (Packaging Material) : (per carton)

No.	Item	Model	Dimensions (mm)	1Pcs Weight	Quantity	Total Weight
1	成品 (LCM)	HNA800480T013IHC09	186.8 X 110.56	0.2	24	4.8
2	多層薄膜(1)POF	OTFILM0BA03ABA	19"X350X0.015	—	4	—
3	TRAY 盤 (2)Tray	TYSG000000464	352 X 260 X 25.56	0.13	16	2.08
4	舒美墊(3) EPE	FOAM000000047	350 X 255 X 5	0.011	8	0.088
5	內盒(4)Product Box	BX00000000022	393 X 274 X 107	0.25	4	1.0
6	保利龍板(5)Polylon board	OTPLB000000008	550 X 393 X 15	0.022	2	0.044
7	外紙箱(6)Carton	BX57041027CCBA	570 X 410 X 265	1.0	1	1.0
8						
9						

2. 一整箱總重量 (Total LCD Weight in carton) : 9.01 Kg±10%

3. 單箱數量規格表 (Packaging Specifications and Quantity) :

(1) LCM quantity per box : no per tray	2	x no of tray	3	=	6
(2) Total LCM quantity in carton : quantity per box	6	x no of boxes	4	=	24

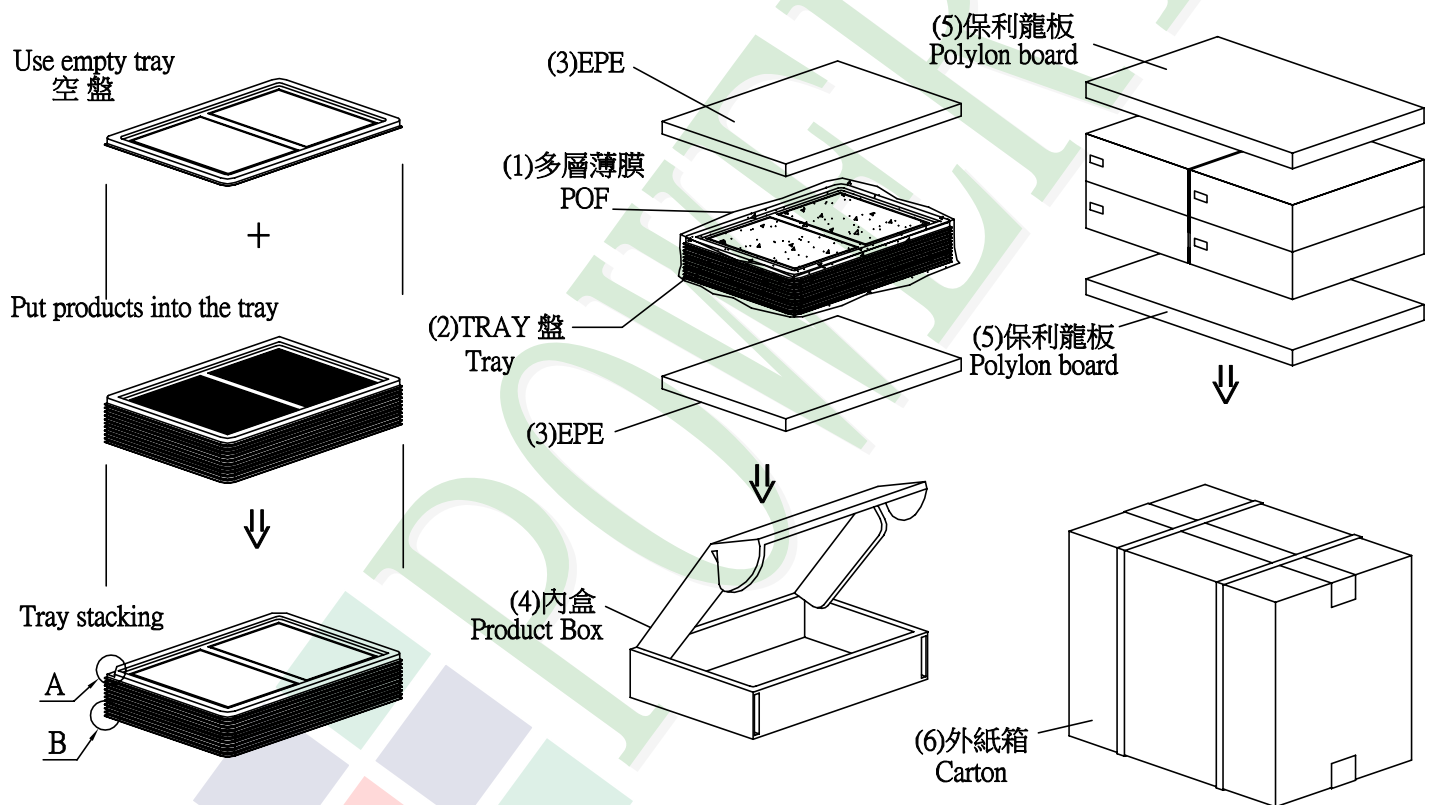

## 特記事項 (REMARK)

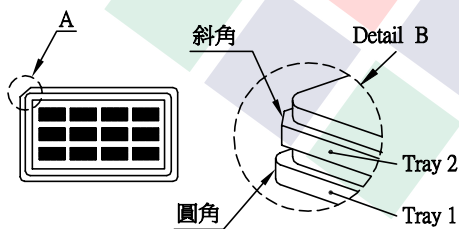

4. TRAY盤相疊時,需旋轉180度,請詳見B視圖  
Rotate tray 180 degrees and place on top of stack.  
Check the tray stack using Fig. B.