

Features:

- Frequency Range: 4.9 to 5.9 GHz
- 46 dBm IP3
- 33 dBm P1dB
- 26 dBm Pout @ 2.0% EVM
- 11.0 dB Gain
- Input and Output Matched to 50 Ω for Easy Cascade
- Surface Mount QFN 5x5mm Package

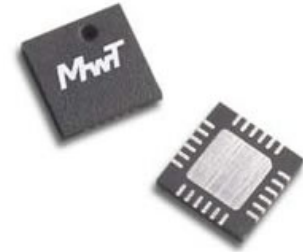

Applications:

- 802.16 WiMax
- 802.11 WLAN
- Point-To-Point Radio Communications
- Telecomm Infrastructure

Description:

The MMA-495933-M5 is a 2.0 watt amplifier pre-matched to 50 ohm operating over frequency range 4.9 GHz to 5.9 GHz. The RF gain is 11.0 dB. The typical output IP3 is 46 dBm and P1dB is 33 dBm. The MMA-495933-M5 amplifier has excellent performance for 802.11 WLAN and 802.16 WiMax applications. At 2.0% error vector magnitude (EVM), the amplifier can achieve an average output power of 26 dBm. The MMA-495933-M5 is packaged in a quad flat no-lead (QFN) with a copper base paddle which offers excellent thermal conductance, reduced lead inductance, small size, near chip-scale footprint and thin profile.

Electrical Specifications: *V_{ds}=7.5V, T_a=25 °C, Z₀=50 ohm, V_{gs} = -0.85v, I_{dg} = 600 mA*

Parameter	Units	Min	Typical	Max
Frequency Range	GHz	4.9		5.9
Small Signal Gain	dB	10.0	11.0	
Input/Output VSWR	N/A		2.0:1/3.7:1	
Pout at 1dB Compression Point	dBm	+32.5	+33.0	
Pout @ 2% EVM (1)	dBm		26	
Output Third Order Intercept (2)	dBm		46	
DC Current	mA		600	
Gate Voltage(VGS)	V		-1.0	
Thermal Resistance Junction to Case	$^{\circ}\text{C}/\text{W}$		16	

(1) The output power is 26 dBm for 2.0% EVM and the test signal is 802.16, 256 carriers, 64 QAM with 2/3 coding factor. The measured EVM includes the accumulated errors (0.8%) from the modulator and driver stages.

(2) The output power per tone is 22 dBm and the tone separation is 20 MHz center at 5.5 GHz.

Typical RF Performance: $V_{ds}=7.5V$, $V_{gs}=-1.0V$, $I_{ds}=600mA$, $Z_0=50\text{ ohm}$, $T_a=25\text{ }^\circ\text{C}$

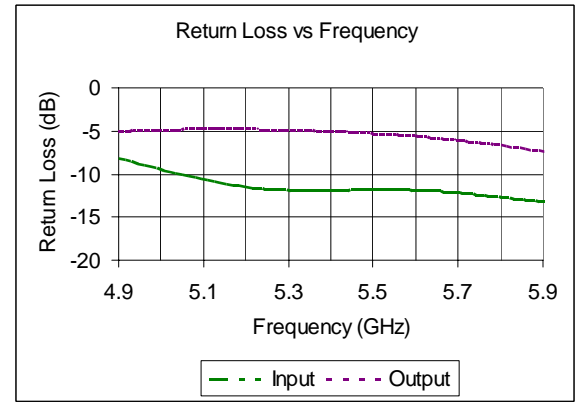
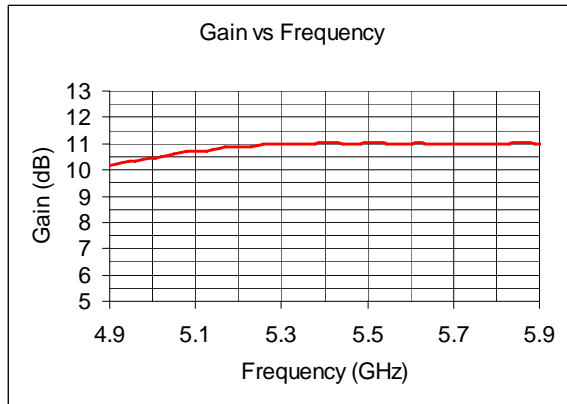
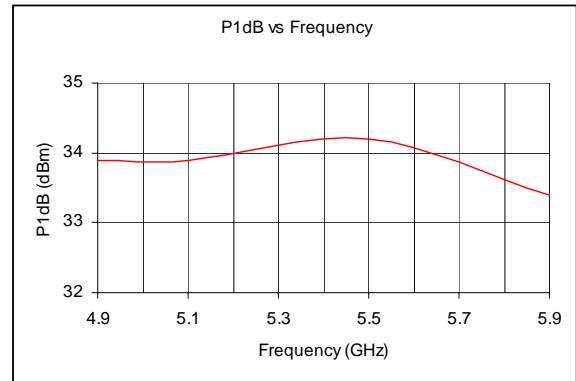
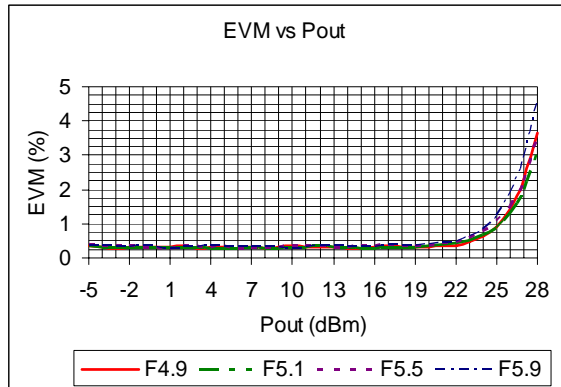



Absolute Maximum Ratings: ($T_a=25\text{ }^\circ\text{C}$)*

PARAMETERS	UNITS	ABSOLUTE MAXIMUM
Bias Voltage (VDS)	V	8.5
Continuous RF Input Power	dBm	+30
Peak Input Power	dBm	+33
Operating Temperature	$^\circ\text{C}$	-40 to +85
Storage Temperature	$^\circ\text{C}$	-65 to +150

*Operation of this device above any one of these parameters may cause permanent damage.

Typical Scattering Parameters: $V_{ds}=7.5\text{V}$, $V_{gs}=-0.9\text{V}$, $I_{ds}=600\text{mA}$, $Z_0=50\text{ ohm}$, $T_a=25\text{ }^\circ\text{C}$

Freq (GHz)	S11		S21		S12		S22	
	MAG	ANG	MAG	ANG	MAG	ANG	MAG	ANG
4.50	0.58	12.98	2.91	0.321	0.039	-65.1	0.42	-123.15
4.60	0.55	-3.95	2.95	-16.40	0.042	-82.14	0.46	-129.49
4.70	0.50	-21.89	3.02	-32.99	0.044	-99.79	0.51	-135.38
4.80	0.47	-41.41	3.09	-49.68	0.047	-117.69	0.54	-140.75
4.90	0.39	-63.21	3.19	-66.76	0.05	-135.82	0.56	-145.62
5.00	0.34	-87.96	3.29	-84.69	0.052	-153.91	0.57	-150.16
5.10	0.29	-116.06	3.38	-103.06	0.054	-172.01	0.58	-154.50
5.20	0.27	-146.83	3.46	-121.82	0.056	169.92	0.57	-158.81
5.30	0.25	-178.36	3.50	-140.56	0.059	151.74	0.57	-163.22
5.40	0.25	151.23	3.52	-159.17	0.061	133.45	0.56	-167.68
5.50	0.26	122.38	3.51	-177.74	0.063	115.10	0.54	-176.57
5.60	0.25	94.62	3.51	163.49	0.064	96.64	0.52	-176.57
5.70	0.25	66.79	3.51	144.51	0.066	77.99	-0.49	179.20
5.80	0.23	37.69	3.51	124.99	0.068	58.98	0.46	175.16
5.90	0.22	6.29	3.51	104.90	0.070	19.74	0.39	167.02
6.00	0.21	-27.52	3.49	84.28	0.072	19.74	0.39	167.02
6.10	0.21	-62.14	3.44	63.09	0.073	-0.53	0.36	162.48
6.20	0.21	-95.69	3.37	41.27	0.073	-21.21	0.32	157.70
6.30	0.20	-128.03	3.27	18.99	0.073	-42.40	0.27	153.51
6.40	0.18	-161.31	3.15	-3.87	0.072	-64.18	0.22	151.77
6.50	0.13	158.70	3.00	-27.27	0.069	-86.44	0.17	156.32

Package Pin-out:

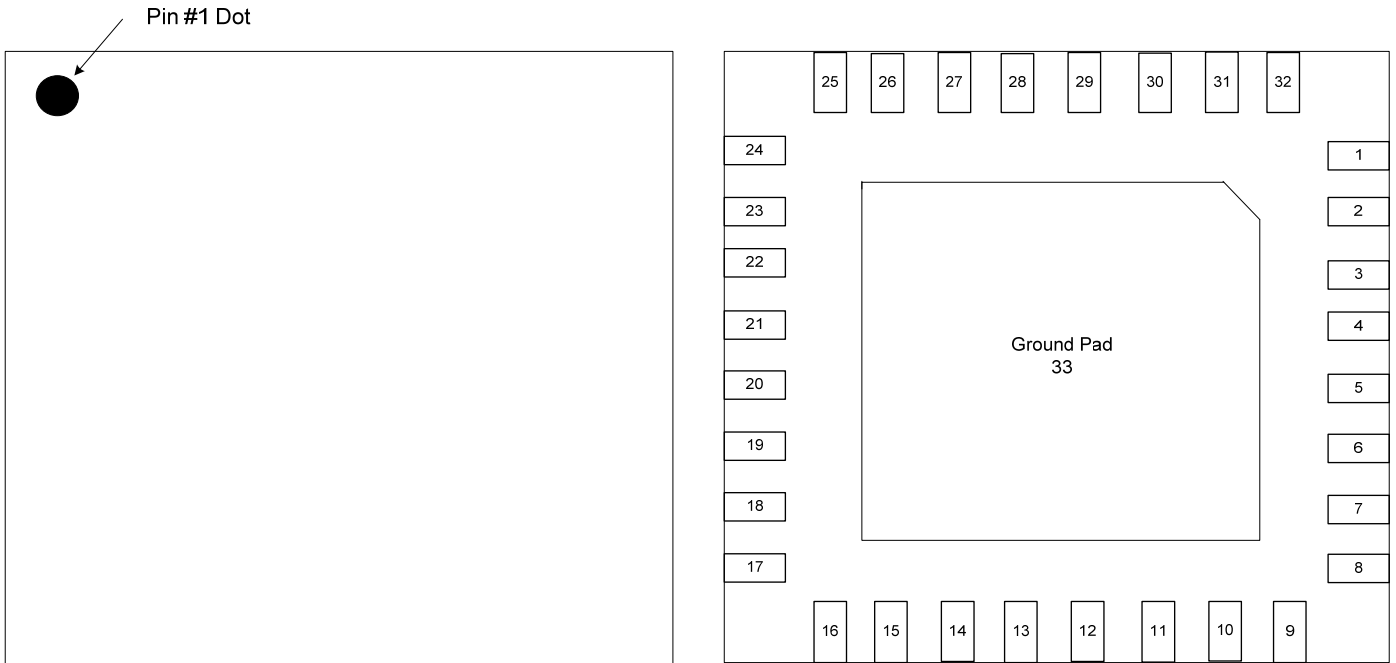

MMA-495933-M5 pinassignment

Pin #	Function	Pin #	Function	Pin #	Function	Pin #	Function
1	GND	9	GND	17	GND	25	GND
2	N/C	10	N/C	18	N/C	26	N/C
3	N/C	11	N/C	19	N/C	27	N/C
4	RF in	12	N/C	20	RF out	28	N/C
5	RF in	13	Vdd	21	RF out	29	Vgs
6	N/C	14	N/C	22	N/C	30	N/C
7	N/C	15	N/C	23	N/C	31	N/C
8	GND	16	GND	24	GND	32	GND

Mechanical Information:

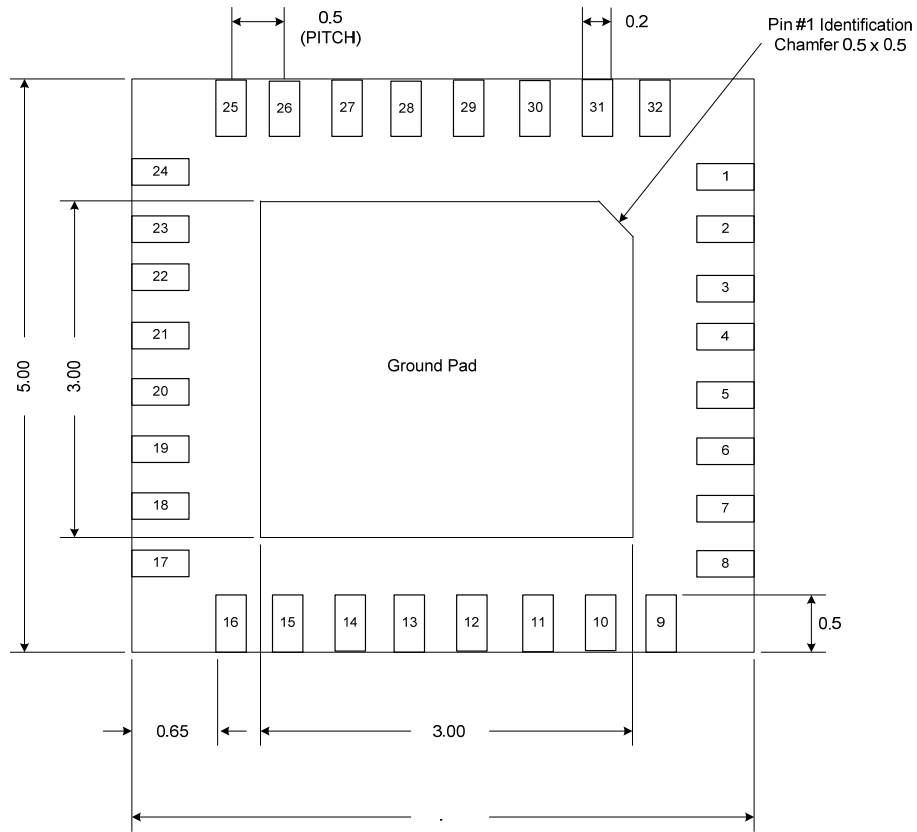

BOTTOM VIEW

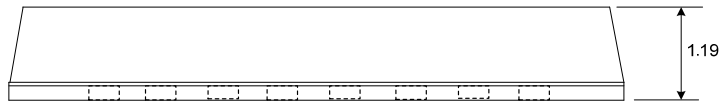

SIDE VIEW

The units are in [mm].

Application Note

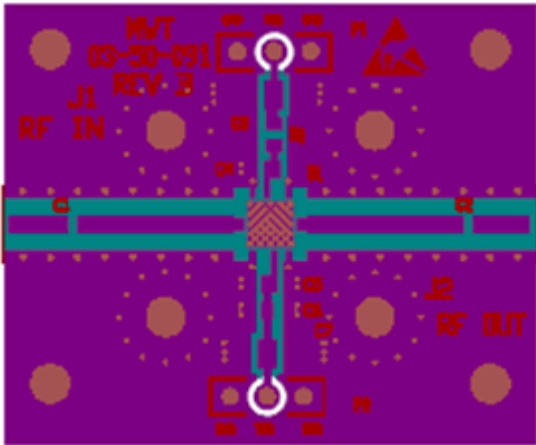

Figure 1 Evaluation Board

The measurements presented are recorded at $V_{dd}=7.5$ volts and $I_{ds}=600$ mA. The evaluation board layout is shown in Figure 1. Rogers 4003 is the choice for many RF board materials because of its high frequency response, temperature stability and low cost. The board height is 20 mils and the copper trace weight is 1 oz. Many through holes with a drill diameter of 12 mils are spread uniformly across the center pad for thermal relief and RF ground. It is recommended that via holes be placed nearby the DC bias connector to maintain ground continuity between the top and bottom ground planes. Mounting holes near the unit will help secure the board to the chassis, minimize ground current loops and improve thermal conductivity in the absence of sweat soldering the board to the chassis.

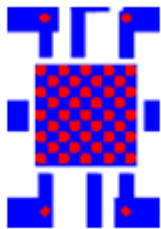

Figure 2 Hole Pattern

The via hole design, shown in Figure 2, uses two via patterns that are interleaved; one is 5x5 and the other is 4x4; the finished via hole diameter is 9 mils. The pitch between holes is 25 mils. The simulated thermal impedance is less than 0.9°C/W . The PCB finish is nickel over copper with a gold flash.

Please consult our factory to request s-parameters, Gerber file and samples.

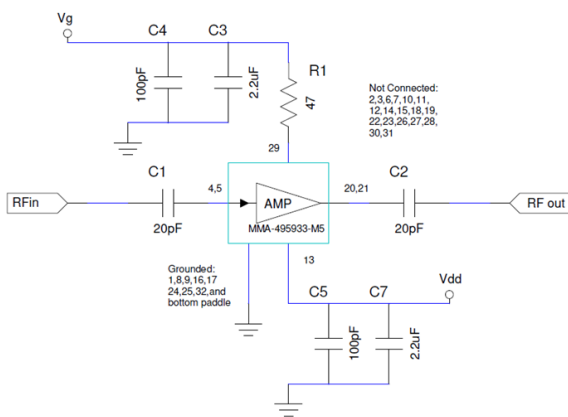

Figure 3, Evaluation Board Schematic

The MMA-495933-M5 amplifier includes two built-in bias tees for gate control at QFN pin 10 and for drain control at QFN pin 22. In addition, the MMA-495933-M5 has its own DC blocking capacitors. The breakdown voltage for the blocking capacitor is 22 VDC. The schematic for the evaluation board is shown in Figure 3. The evaluation board has two bias terminals; terminal P1 is for gate control and terminal P2 is for drain control. The gate control should be adjusted first before setting the drain. The typical gate voltage is -1.0 volts and the drain voltage is 7.5 volts. The bias current is approximately 600 mA with no RF applied. These bias conditions can vary with the application requirements; that is, setting lower current for low power or setting higher current for pristine performance.

Application Note (continued)

The typical small signal gain response, shown in Figure 4, varies from 10 to 11 dB over the frequency range 4.9 to 5.9 GHz. The output IP3 response shown in Figure 5 uses a two tone separation of 20 MHz at 4.9 and 5.9 GHz. Notice that linearity of this amplifier is maintained at very low power levels which give rise to better signal to noise interference ratio.

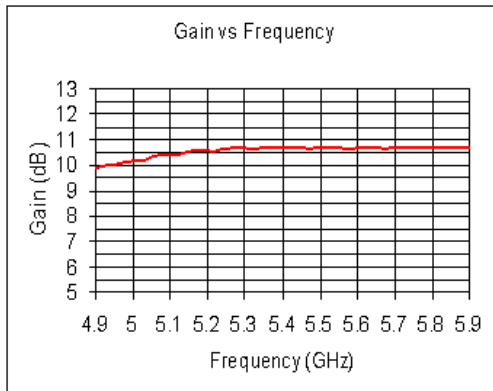

Figure 4 Gain Response

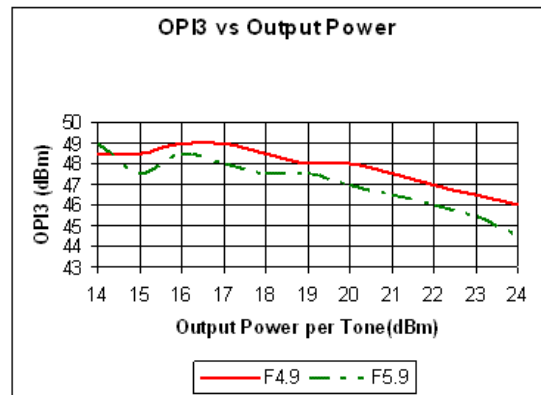

Figure 5 OIP3

A block diagram of the WiMAX test setup is shown in Figure 6. The burst frame length is 141 symbols and the channel bandwidth is 3.5 MHz. A summary of the burst is shown in Figure 7.

The measured EVM error is segmented into two sections. The SMU200A contributes about 0.5%, and the driver contributes about 0.3% to the total EVM. The EVM measurement includes the 0.8% error from the driver and source. The residual EVM error for the MMA-495933-M5 is 1.2% at burst power of 27 dBm.

Burst	Area	Modulation	Length	Power(dBm)	EVM(dB)
Burst 1	Preamble	BPSK	1	29.72	-39.6
	Data	BPSK	11	26.83	-33.74
Burst 2	Data	QPSK	20	26.82	-34.25
Burst 3	Data	16QAM	30	26.82	-34.1
Burst 4	Data	64QAM	79	26.79	-34.21
Overall			141	27.57	-34.74

Figure 7 Example of Burst Summary

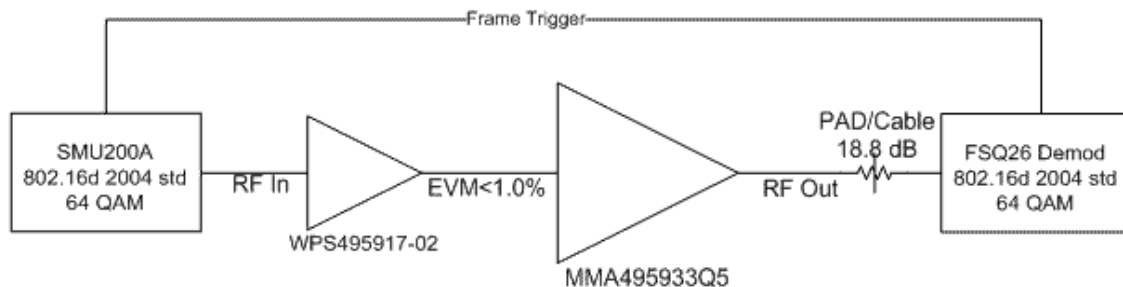

Figure 6 WiMax Test Setup

Application Note (continued)

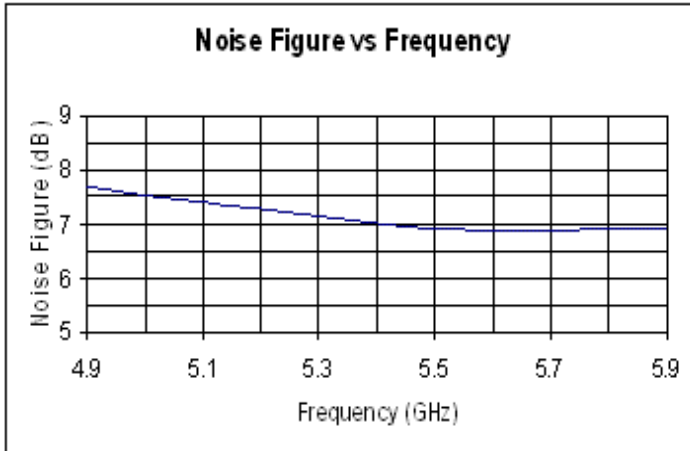

Figure 8 Noise Figure

The noise figure, shown in Figure 8, is less than 8.0 dB across the frequency range 4.9 to 5.9 GHz. The MMA-495933-M5 includes a stability resistor that adds to the noise figure.

The typical noise floor for an on-chip WiMAX modulator is -107 dBm per MHz. Assume that the total system gain is approximately 35 dB and the pre-driver stage used has a gain of 25 and noise figure of 5.5 dB. The noise floor to PA is -79 dBm per MHz. The noise floor at the output of the MMA-495933-M5 is -68.5 dBm per MHz. This shows that sensitivity for this system is -29 dBm per 3.5 MHz for SNR = 34 dB. The MMA-495933-M5 does not noise limit the system performance.

IEEE 802.16-2004 OFDM			
Frequency: 5.5 GHz	Signal Level Setting: 7.4 dBm	External Att: 18.8 dB	
Sweep Mode: Continuous	Trigger Mode: External	Trigger Offset: -10 μs	
Burst Type: OFDM DL Burst	Modulation: ALL	No Of Data Symbols: 1/2425	

Result Summary							
No. of Bursts	4						
	Min	Mean	Limit	Max	Limit	Unit	
EVM All Carriers	1.94	1.98	2.82	2.05	2.82	%	
EVM Data Carriers	1.95	1.98		2.05		%	
EVM Pilot Carriers	1.83	1.90		2.05		%	
IQ Offset	0.13	0.13	17.78	0.13	17.78	%	
Gain Imbalance	0.08	0.08		0.08		%	
Quadrature Error	- 0.002	- 0.002		- 0.002		°	
Center Frequency Error	244.27	244.27	± 44000	244.27	± 44000	Hz	
Clock Error	0.03	0.03	± 8	0.03	± 8	ppm	
Burst Power	27.12	27.15		27.16		dBm	
Crest Factor	8.32	8.53		8.77		dB	
RSSI	11.26	11.26		11.26		dBm	
RSSI Standard Deviation		- 11.16				dB	
CINR	39.70	39.70		39.70		dB	
CINR Standard Deviation		2.83				dB	

Figure 9 802.16 256 carriers, 64 QAM at 5.5 GHz, Pavg=27.1 dBm @ EVM=2%

Application Note (continued)

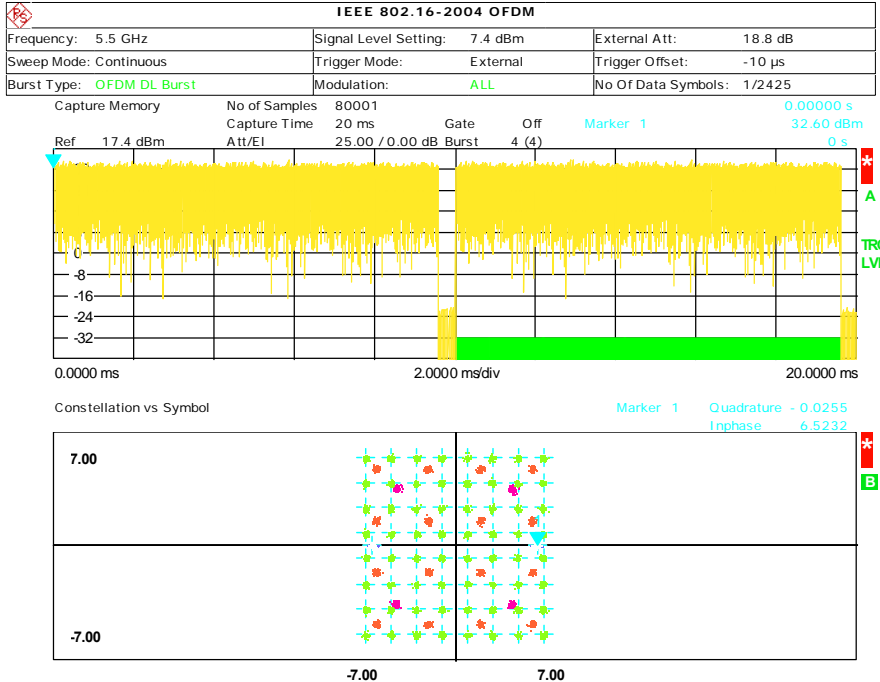

Figure 10

WiMax constellation $P_{avg}=27$ dBm at 5.5 GHz for 2.0% EVM for all carriers.

The test pattern is 256 carriers and modulations are QPSK, 16QAM and 64 QAM.

The signal power versus time is shown in yellow.

The constellation shown represents QPSK, 16QAM and 64 QAM.

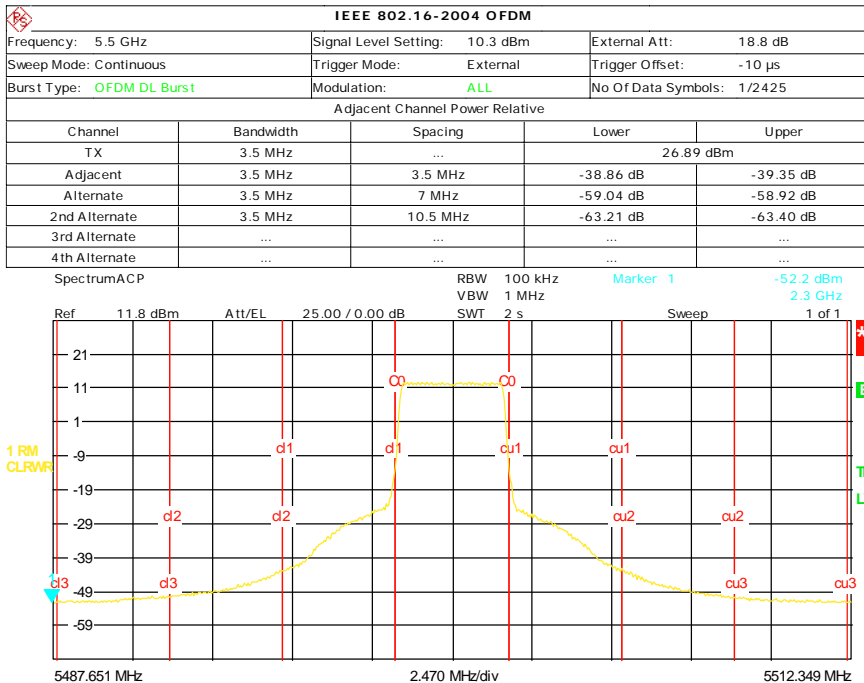

Figure 11

ACPR at $P_{avg}=27$ dBm at 5.5 GHz. The channel bandwidth is 3.5 MHz. The first adjacent channel ratio is -39 dBc; the second channel ratio is -59 dBc.