



P3M06300K3 SiC MOS N-Channel Enhancement Mode

V_{RRM} = 650 V
 I_D = 9 A
 $I_D(100^\circ\text{C})$ = 7 A
 $R_{DS(on)}$ = 300 m Ω

SiC MOS P3M06300K3 N-Channel Enhancement Mode



Features

- High Blocking Voltage with Low On-Resistance
- High-Frequency Operation
- Ultra-Small Q_{gd}
- 100% UIS tested

Standards Benefits

- Improve System Efficiency
- Increase Power Density
- Reduce Heat Sink Requirements
- Reduction of System Cost

Applications

- Solar Inverters
- Active Clamp Flyback, LLC resonant, Class D
- Mobile fast-chargers, adapters
- Notebook adaptors
- High Voltage DC/DC Converters
- Switch Mode Power Supplies

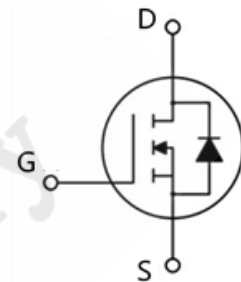

TO-247-3

Gate	1
Drain	2
Source	3



Order Information

Part number	Package	Marking
P3M06300K3	TO-247-3	P3M06300K3



Contents

Features.....	1
Standards Benefits	1
Applications.....	1
Order Information	1
Contents.....	2
1. Maximum Ratings.....	3
2. Electrical Characteristics	4
3. Reverse Diode Characteristics.....	5
4. Thermal Characteristics.....	5
5. Typical Performance	6
6. Package Outlines.....	10

PNJ Preliminary



1. Maximum Ratings

At $T_J = 25^\circ\text{C}$, unless specified otherwise

Parameter	Symbol	Value	Unit	Test Conditions
Drain - Source Voltage	V_{DSmax}	650	V	$V_{GS} = -3\text{V}$ $I_D = 100\mu\text{A}$
Gate - Source Voltage (dynamic)	V_{GSmax}	-8 / +20	V	AC ($f > 1\text{ Hz}$)
Gate - Source Voltage (static)	V_{GSop}	-3 / +15	V	Static
Continuous Drain Current	I_D	9	A	$V_{GS} = 15\text{V}$ $T_C = 25^\circ\text{C}$
		7		$V_{GS} = 15\text{V}$ $T_C = 100^\circ\text{C}$
Power Dissipation	P_D	38	W	
Operating Junction	T_J	-55 To +175	$^\circ\text{C}$	
Storage Temperature	T_{stg}	-55 To +175	$^\circ\text{C}$	
Solder Temperature	T_L	260	$^\circ\text{C}$	
Mounting Torque	M_d	1 8.8	Nm lbf-in	M3 or 6-32 screw



2. Electrical Characteristics

At $T_J = 25^\circ\text{C}$, unless specified otherwise

Parameter	Symbol	Value			Unit	Test Conditions
		Min.	Typ.	Max.		
Drain-Source Breakdown Voltage	$V_{(BR)DSS}$	650	/	/	V	$V_{GS} = -3V$ $I_D = 100\mu A$
Gate Threshold Voltage	$V_{GS(th)}$	1.8	2.2	/	V	$V_{DS} = V_{GS}$ $I_D = 5mA$ $T_J = 25^\circ\text{C}$
		/	1.45	/	V	$V_{DS} = V_{GS}$ $I_D = 5mA$ $T_J = 175^\circ\text{C}$
Reverse Bias Drain Current	I_{DSS}	/	0.5	10	μA	$V_{GS} = -3V$ $V_{DS} = 650V$
Gate-Source Leakage Current	I_{GSS}	/	20	250	nA	$V_{GS} = 15V$ $V_{DS} = 0V$
Drain-Source On-State Resistance	$R_{DS(on)}$	/	300	500	m Ω	$V_{GS} = 15V$ $I_D = 4.5A$
Trans conductance	g_{fs}	/	2.7	/	S	$V_{DS} = 20V$ $I_{DS} = 4.5A$ $T_J = 25^\circ\text{C}$
		/	2.3	/	S	$V_{DS} = 20V$ $I_{DS} = 4.5A$ $T_J = 175^\circ\text{C}$
Input Capacitance	C_{iss}	/	338	/	pF	$V_{GS} = 0V$ $V_{DS} = 400V$ $f = 1MHz$ $V_{AC} = 25mV$
Output Capacitance	C_{oss}	/	39.4	/	pF	
Reverse Transfer Capacitance	C_{rss}	/	3.35	/	pF	
Coss Stored Energy	E_{oss}	/	5.6	/	μJ	



P3M06300K3 SiC MOS N-Channel Enhancement Mode

Parameter	Symbol	Value			Unit	Test Conditions
		Min.	Typ.	Max.		
Gate to Source Charge	Q_{gs}	/	2.45	/	nC	$V_{DS} = 400V$ $I_{DS} = 4.5A$ $V_{GS} = -3 \text{ to } 15V$ $I_G = 4mA$
Gate to Drain Charge	Q_{gd}	/	2.75	/		
Total Gate Charge	Q_g	/	9.04	/		

3. Reverse Diode Characteristics

At $T_J = 25^\circ C$, unless specified otherwise

Parameter	Symbol	Value		Unit	Test Conditions
		Typ.	Max.		
Diode Forward Voltage	V_{SD}	4.5	/	V	$V_{GS} = -3V$ $I_{SD} = 2.75A$ $T_J = 25^\circ C$
		4	/	V	$V_{GS} = -3V$ $I_{SD} = 2.75A$ $T_J = 175^\circ C$
Continuous Diode Forward Current	I_S	7	/	A	$V_{GS} = -3V$

4. Thermal Characteristics

Parameter	Symbol	Value	Unit
Thermal Resistance from Junction to Case	$R_{\theta JC}$	3.93	$^\circ C/W$

5. Typical Performance

At $T_J = 25^\circ\text{C}$, unless specified otherwise

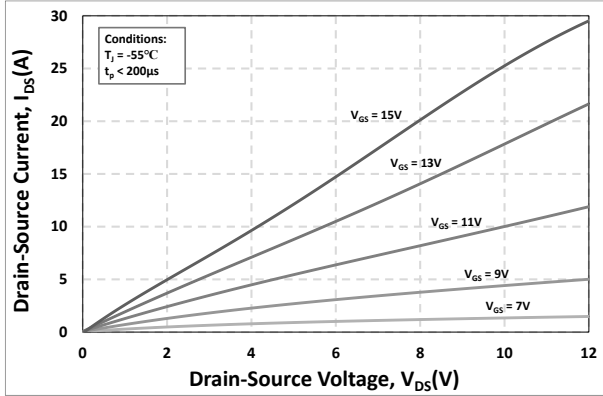

Figure 1. Output Characteristics $T_J = -55^\circ\text{C}$

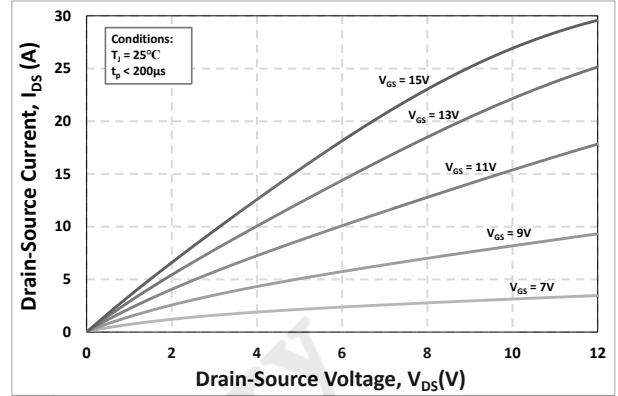

Figure 2. Output Characteristics $T_J = 25^\circ\text{C}$

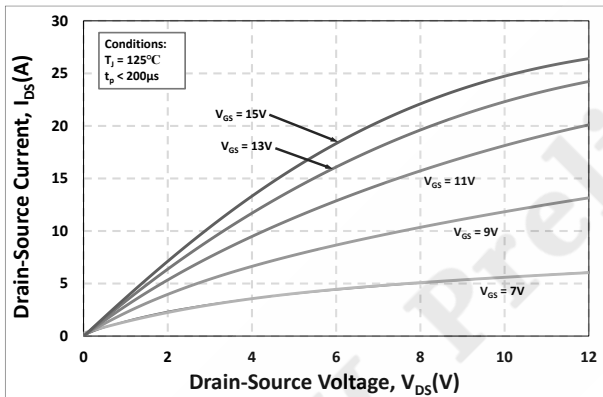

Figure 3. Output Characteristics $T_J = 125^\circ\text{C}$

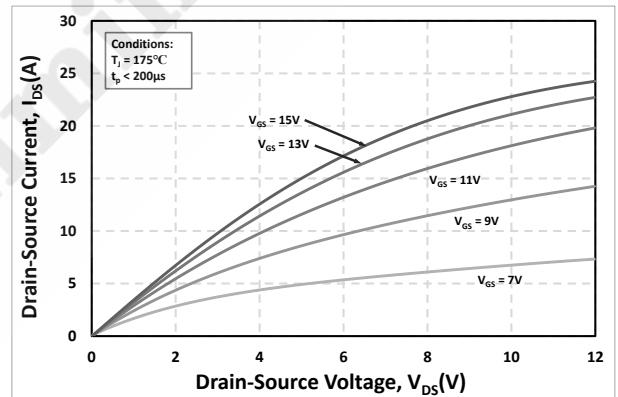

Figure 4. Output Characteristics $T_J = 175^\circ\text{C}$

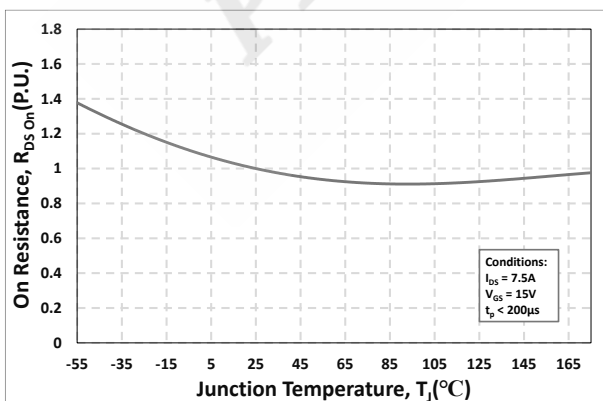

Figure 5. Normalized On-Resistance vs. Temperature

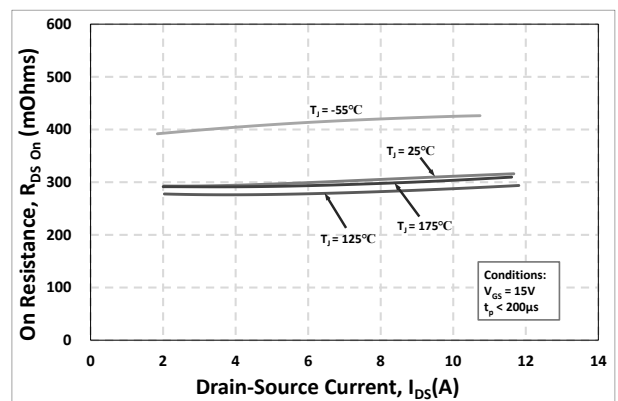

Figure 6. On-Resistance vs. Drain Current Various Temperatures

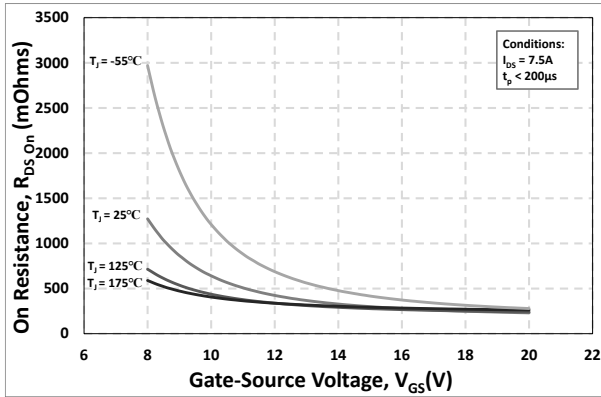

Figure 7. On-Resistance vs. Gate-Source Voltage

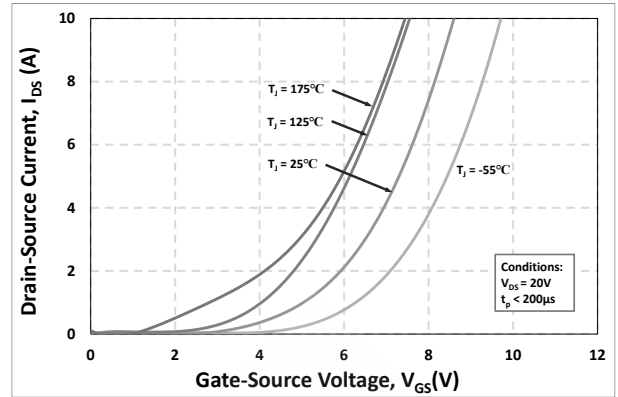

Figure 8. Transfer Characteristic for Various Junction Temperatures

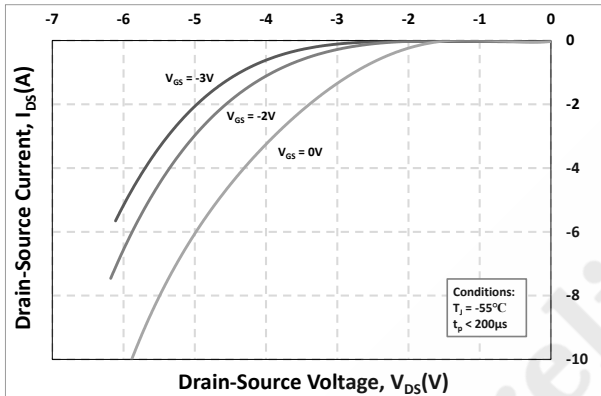

Figure 9. Body Diode Characteristic at -55°C

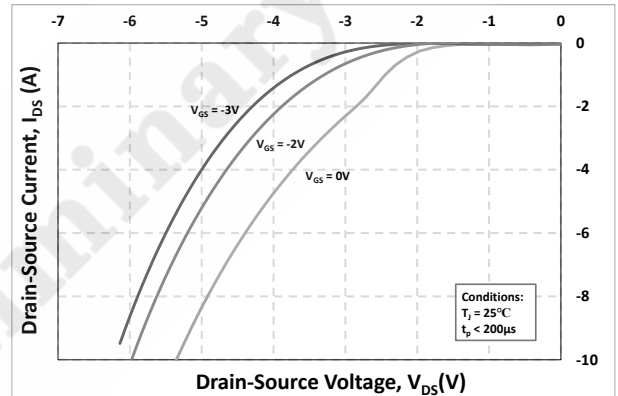

Figure 10. Body Diode Characteristic at 25°C

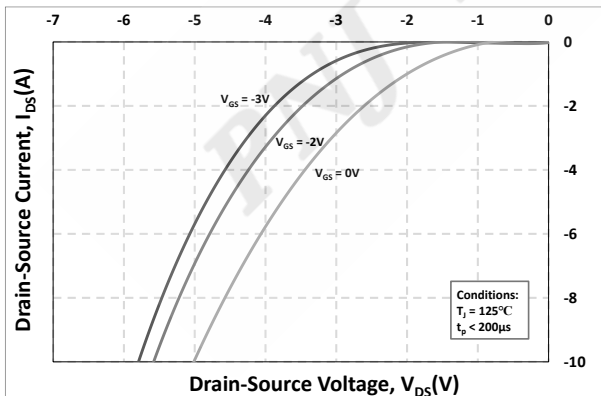

Figure 11. Body Diode Characteristic at 125°C

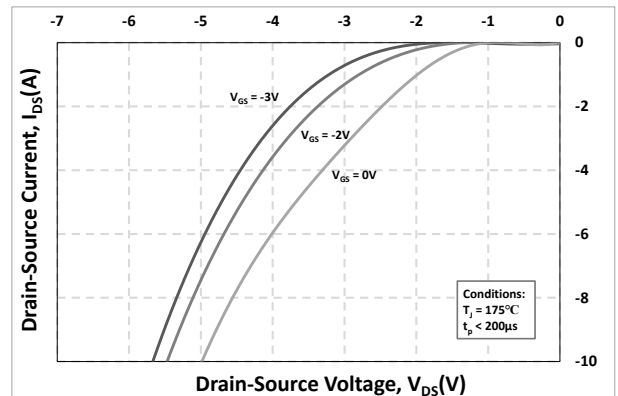

Figure 12. Body Diode Characteristic at 175°C



P3M06300K3 SiC MOS N-Channel Enhancement Mode

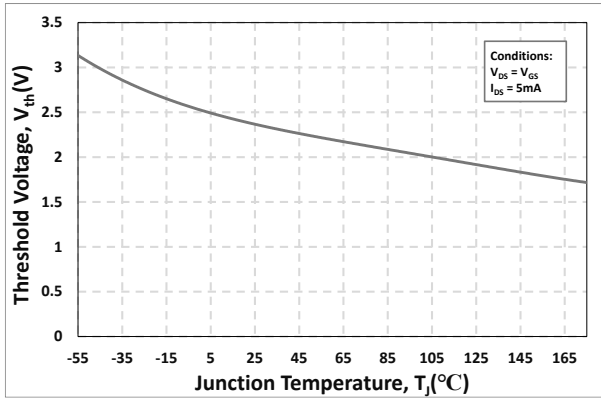

Figure 13. Threshold Voltage vs. Temperature

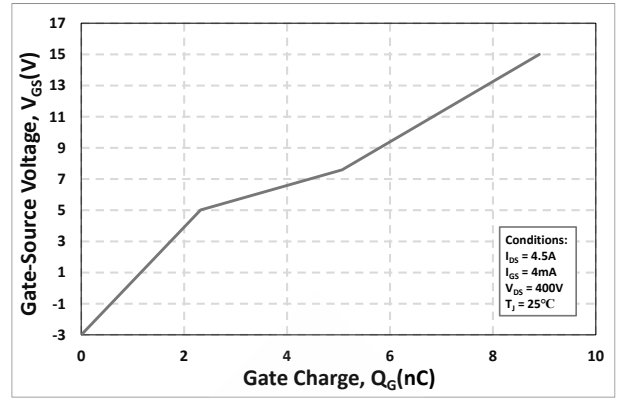

Figure 14. Gate Charge Characteristics

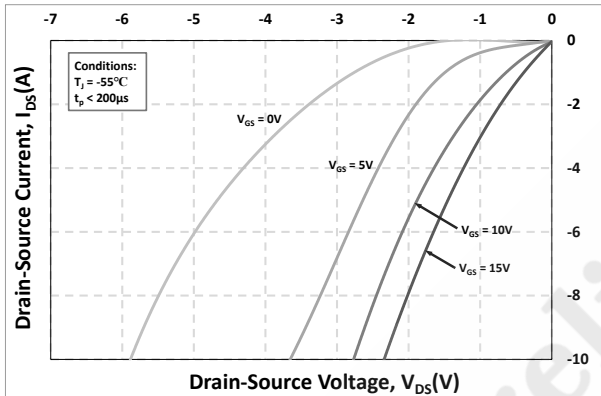

Figure 15. 3rd Quadrant Characteristic at -55°C

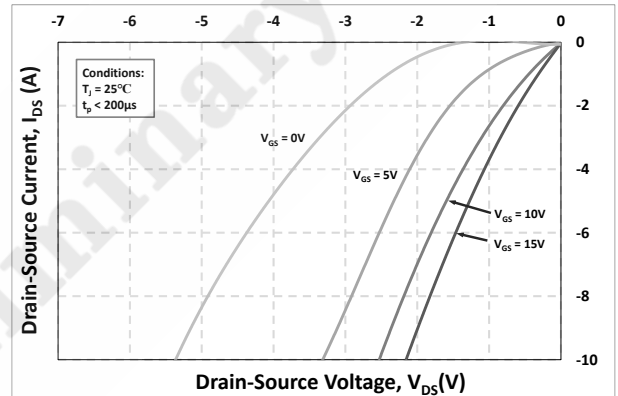

Figure 16. 3rd Quadrant Characteristic at 25°C

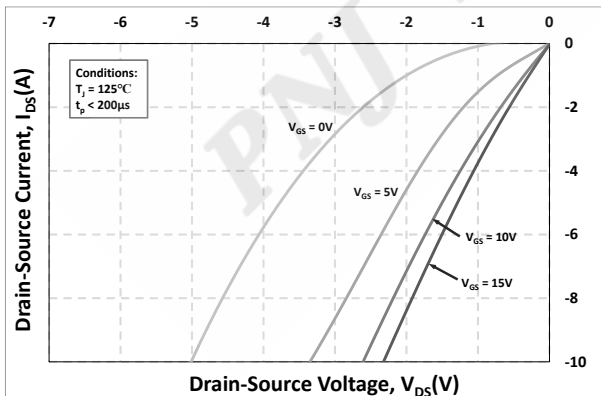

Figure 17. 3rd Quadrant Characteristic at 125°C

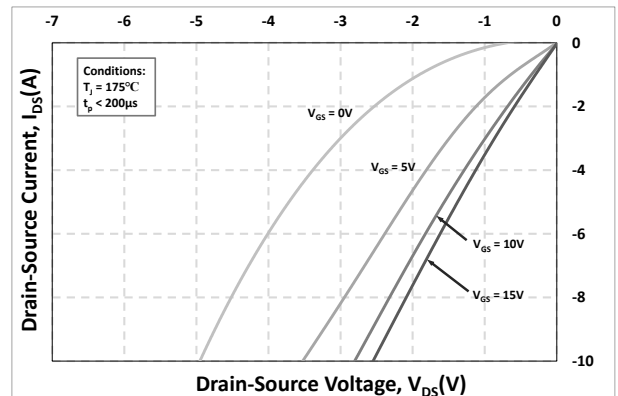

Figure 18. 3rd Quadrant Characteristic at 175°C



P3M06300K3 SiC MOS N-Channel Enhancement Mode

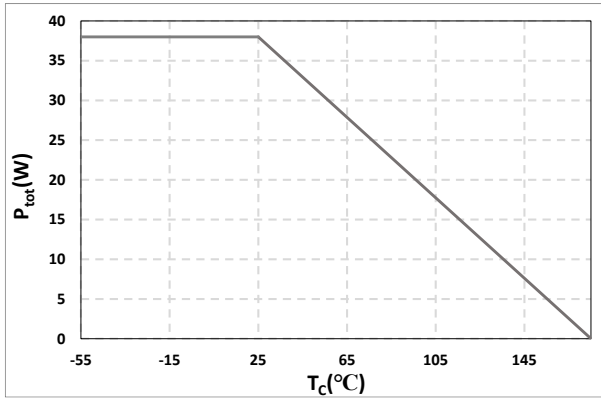

Figure 19. Maximum Power Dissipation Derating vs. Case Temperature

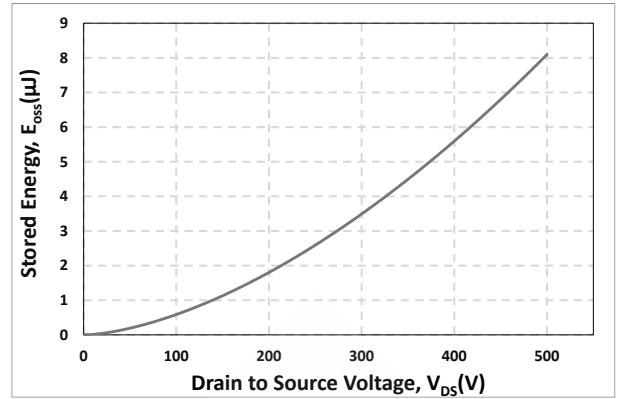

Figure 20. Output Capacitor Stored Energy

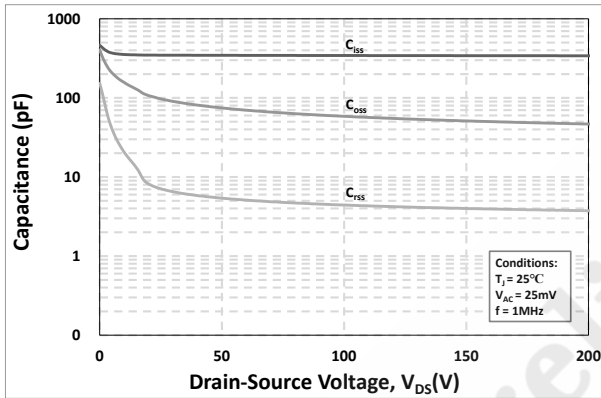

Figure 21. Capacitances vs. Drain-Source Voltage (0 - 200V)

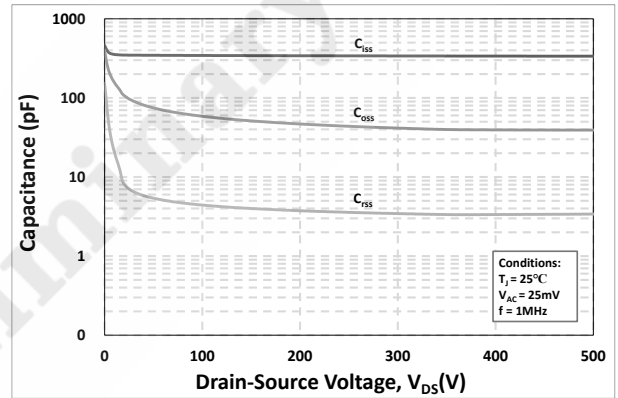
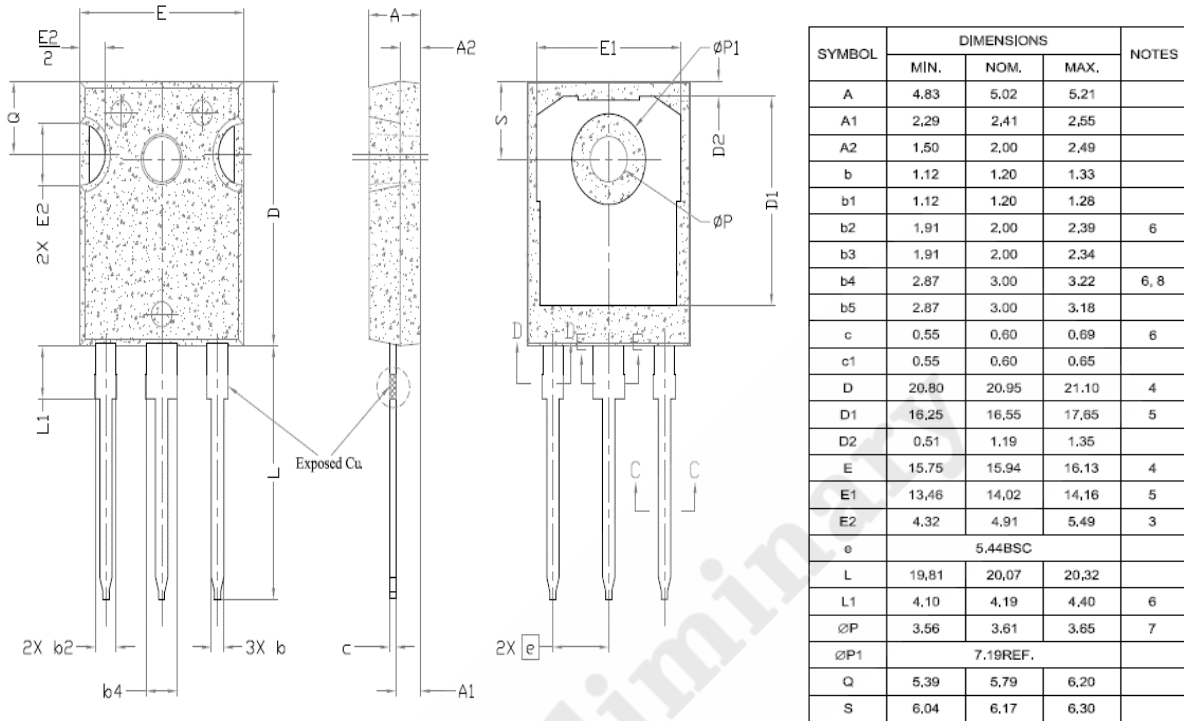

Figure 22. Capacitances vs. Drain-Source Voltage (0 - 500V)

6. Package Outlines



Drawing and Dimensions

PNJ Preliminary