

# Current-compensated choke series for lighting applications

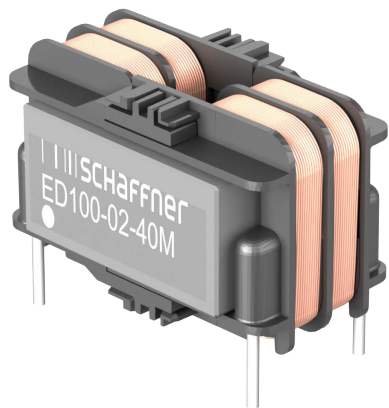

- Common and differential mode inductance
- Very high differential-mode inductance
- Rated currents up to 2 A
- Broadband attenuation characteristics



### Performance indicators

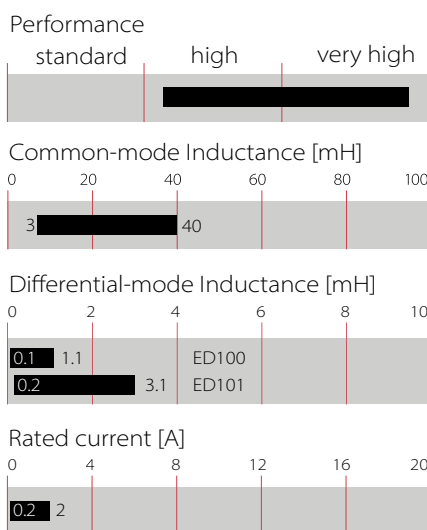

### Approvals & Compliances

### ROHS

Lighting LED drivers need to be high in efficiency, low in cost and compliant to EMC regulations. The ED100 / ED101 series increases the efficiency of a LED driver circuit by reducing the need for X-capacitors. Thus, the power factor rises, and less unwanted reactive power is generated. The inductor is a combination of a strong common-mode inductance with a significant differential-mode inductance. It offers two filtering elements in one component. This helps the circuit designer to reduce the number of elements on the PCB, to reduce space requirement as well as lowering costs. Combined with the high MTBF value of the ED100 / ED101 series, a circuit design with reduced number of components profits for its overall reliability and lifetime.

### Features and benefits

- Increases power factor
- Combination of common- and differential-mode inductances
- Rated currents up to 2 A
- Compact and light-weight
- Small PCB footprint

### Technical specifications

<b>Maximum continuous operating voltage</b>	300 VAC, 50/60 Hz
<b>Rated currents</b>	0.2 to 2 A @ 65°C
<b>Rated inductance</b>	3 to 40 mH common-mode
<b>Stray inductance</b>	0.1 - 3.1 mH
<b>Operating frequency</b>	DC to 60 Hz
<b>Temperature range (operation and storage)</b>	-40°C to 125°C
<b>Climatic class</b>	40/125/56 acc. IEC 60068-1
<b>High potential test voltage winding-to-winding @ 25°C</b>	1500 VAC, 2 sec
<b>Creepage and clearance distances</b>	Creepage > 3 mm / Clearance > 2.5 mm between windings
<b>Overvoltage category</b>	II acc. IEC 60664-1
<b>Design corresponding to</b>	IEC 60938-1/-2
<b>Inductance reduction (DC bias with IN)</b>	Less than 10% at rated current
<b>Cooling</b>	AN - natural convection
<b>Flammability corresponding to</b>	UL 94 V-0
<b>Altitude</b>	Derating above 2,000 m
<b>Protection category</b>	IP 00
<b>Pollution degree</b>	PD2 acc. IEC 60664-1
<b>MTBF</b>	> 13,000,000 hours acc. MIL-HDBK-217
<b>Vibration and shock</b>	3M4 acc. IEC 60721-3-3

### Typical applications

- Mains operated LED drivers
- Electronic ballasts
- Input filters for switch mode power supplies

### Typical electrical schematic

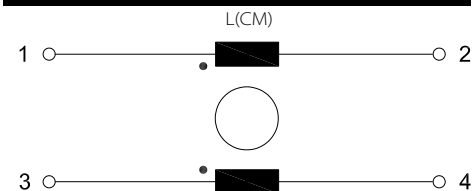

## Choke selection table - ED100 - High Differential-Mode Inductance

ED100 choke	Buy	Rated current I (@65°C) [A]	Common- Mode Inductance	Differential- Mode Inductance	DC resistance R (@25°C) [Ω]	Weight [g]
			L (CM)	L (DM)		
			(@10kHz) [mH]	(@10kHz) [mH]		
ED100-0.2-40M		0.2	40	1.1	10.0	10
ED100-0.3-27M		0.3	27	0.8	5.5	10
ED100-0.4-20M		0.4	20	0.6	3.7	10
ED100-0.5-15M		0.5	15	0.4	2.0	10
ED100-0.75-12M		0.75	12	0.3	1.2	11
ED100-1-9M0		1	9	0.3	0.6	12
ED100-1.25-7M0		1.25	7	0.2	0.4	13
ED100-1.5-5M0		1.5	5	0.1	0.3	13
ED100-2-3M0		2	3	0.1	0.2	13

## Choke selection table - ED101 - Very High Differential-Mode Inductance

ED101 choke	Buy	Rated current I (@65°C) [A]	Common- Mode Inductance	Differential- Mode Inductance	DC resistance R (@25°C) [Ω]	Weight [g]
			L (CM)	L (DM)		
			(@10kHz) [mH]	(@10kHz) [mH]		
ED101-0.2-40M		0.2	40	3.1	10.0	11
ED101-0.3-27M		0.3	27	2.1	5.5	11
ED101-0.4-20M		0.4	20	1.5	3.7	11
ED101-0.5-15M		0.5	15	1.2	2.0	12
ED101-0.75-12M		0.75	12	0.9	1.2	12
ED101-1-9M0		1	9	0.7	0.6	13
ED101-1.25-7M0		1.25	7	0.5	0.4	14
ED101-1.5-5M0		1.5	5	0.4	0.3	14
ED101-2-3M0		2	3	0.2	0.2	14

Test conditions: Measuring frequency: 10 kHz; 50 mV; Inductance tolerance: +50%, -30%; Resistance tolerance: ±15% @ 25°C; Electrical characteristics @ 25°C: ±2°C;  
Differential-mode inductance measurement between pin 1 and 2 (pin 3 and 4 shorted)  
For mechanical tolerances refer to mechanical data section.

## Current derating

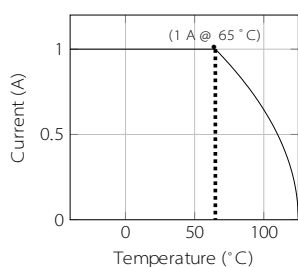

Derating curve normalized to 1 A

## Distribution inventory

Up-to-date inventory levels for global distributors is available at

<https://products.schaffner.com/stock>



### Typical choke attenuation - ED100 - High Differential-Mode Inductance

Per CISPR 17; 50 Ω/50 Ω asym

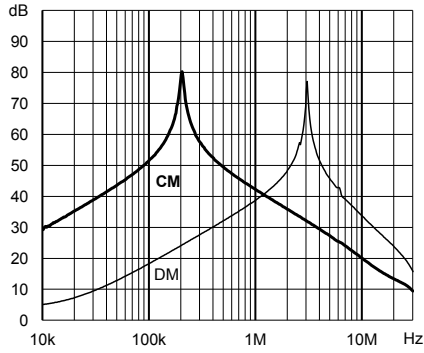

ED100-0.2-40M

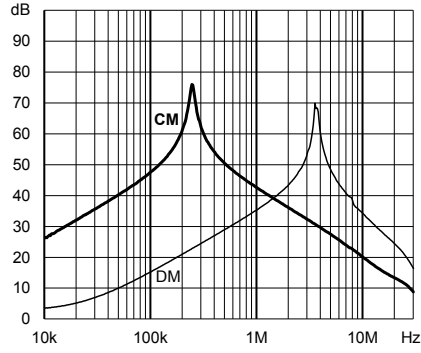

ED100-0.3-27M

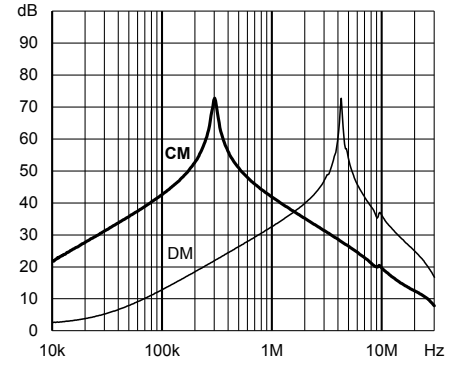

ED100-0.4-20M

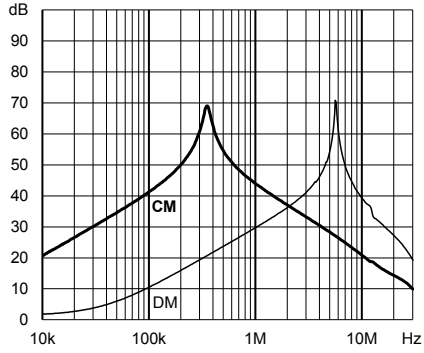

ED100-0.5-15M

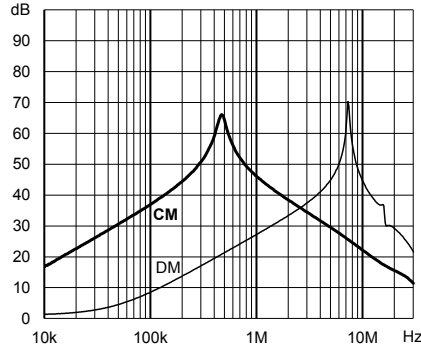

ED100-0.75-12M

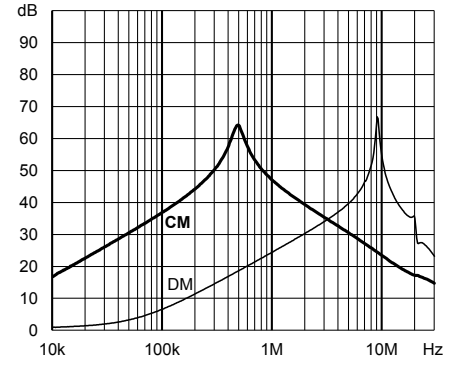

ED100-1-9M0

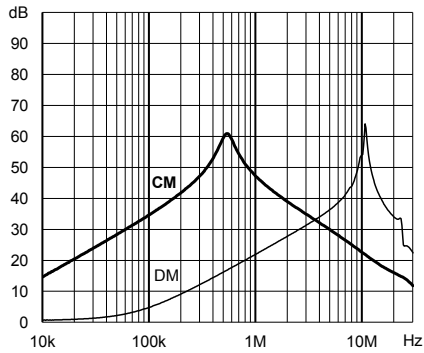

ED100-1.25-7M0

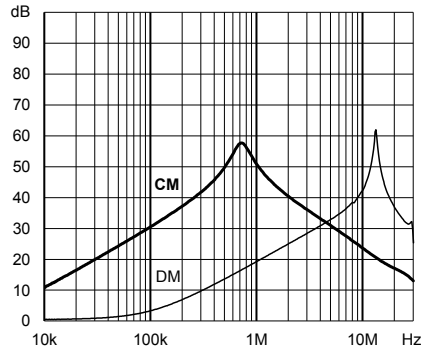

ED100-1.5-5M0

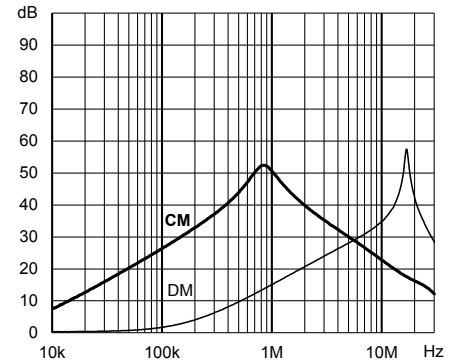

ED100-2-3M0

### Typical choke attenuation - ED101 - Very High Differential-Mode Inductance

Per CISPR 17; 50 Ω/50 Ω asym

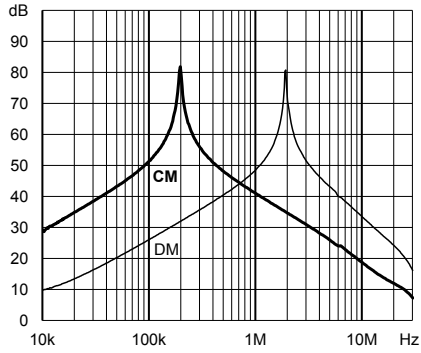

ED101-0.2-40M

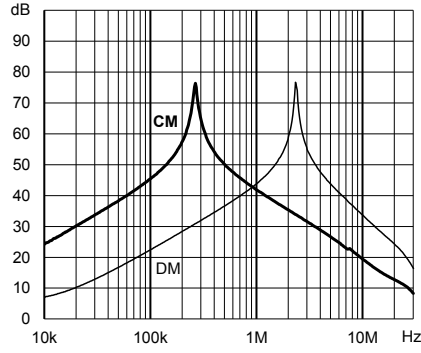

ED101-0.3-27M

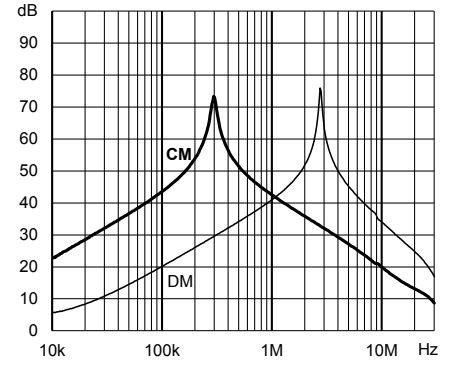

ED101-0.4-20M

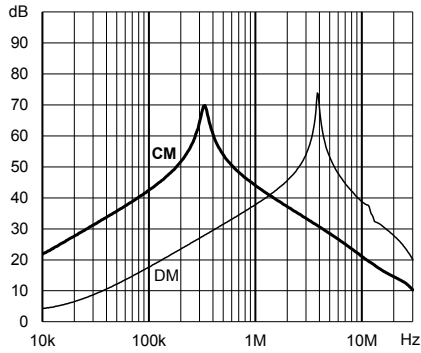

ED101-0.5-15M

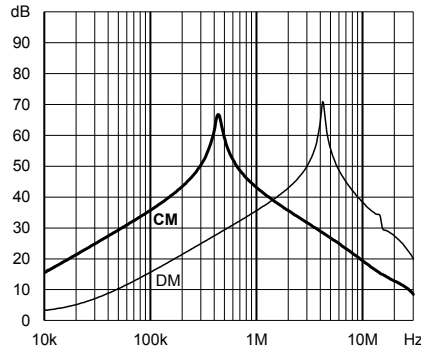

ED101-0.75-12M

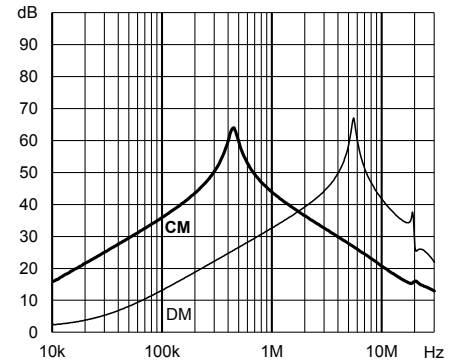

ED101-1-9M0

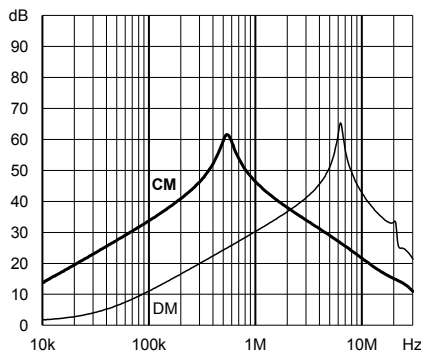

ED101-1.25-7M0

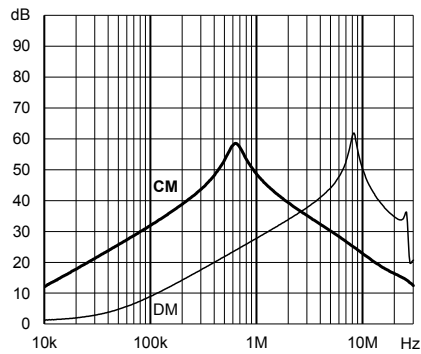

ED101-1.5-5M0

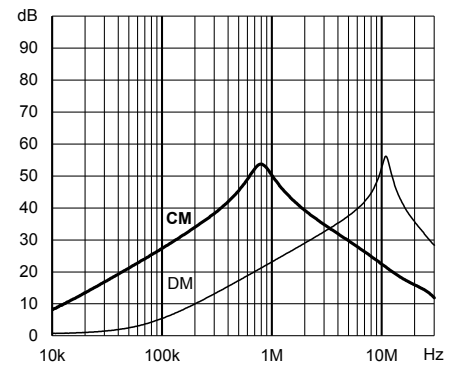

ED101-2-3M0

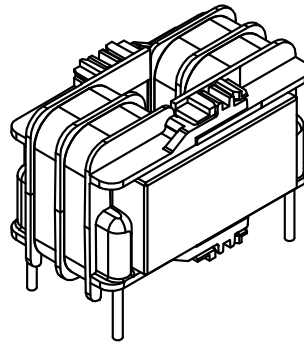
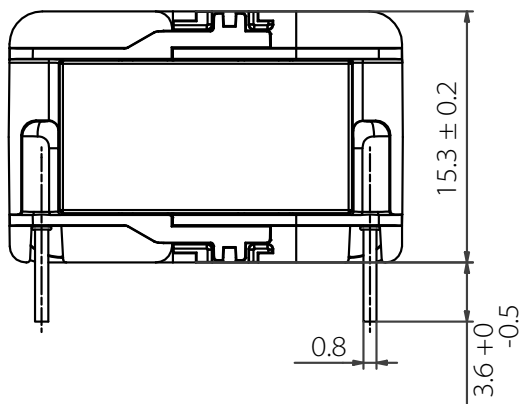
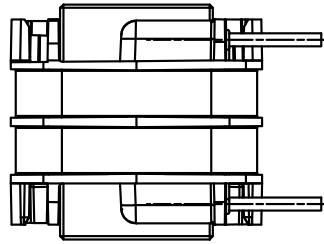
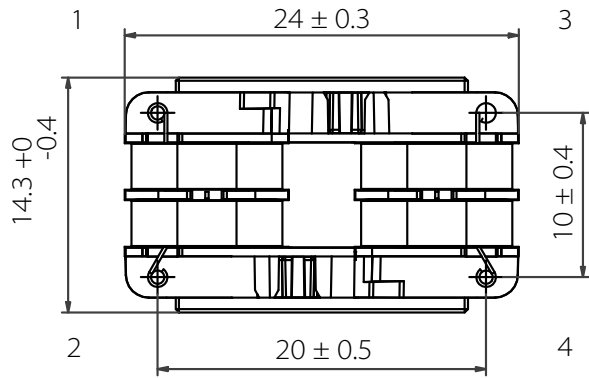
**Mechanical data - ED100 / ED101**

For dimensions [mm] without tolerances: ISO2768-m/EN22768-m applies

Pin material: Steel (base), Cu (under plating), Sn (final plating  $6\mu\text{m}$ )

Pin 1 marked with "dot" on label



## Headquarters, global innovation and development

### Switzerland

#### Schaffner Group

Industrie Nord  
Nordstrasse 11e  
4542 Luterbach  
T +41 32 681 66 26  
[info@schaffner.com](mailto:info@schaffner.com)



## Sales and application centers

### China

#### Schaffner EMC Ltd. Shanghai

T20-3 C, No 565 Chuangye Road,  
Pudong district  
201201 Shanghai  
T +86 21 3813 9500  
[cschina@schaffner.com](mailto:cschina@schaffner.com)  
[www.schaffner.com.cn](http://www.schaffner.com.cn)

### Finland

#### Schaffner Oy

Sauvonrinne 19 H  
08500 Lohja  
T +358 50 468 7284  
[finlandsales@schaffner.com](mailto:finlandsales@schaffner.com)

### France

#### Schaffner EMC S.A.S.

16-20 Rue Louis Rameau  
95875 Bezons  
T +33 1 34 34 30 60  
F +33 1 39 47 02 28  
[francesales@schaffner.com](mailto:francesales@schaffner.com)

### Germany

#### Schaffner Deutschland GmbH

Schoemperlenstrasse 12B  
76185 Karlsruhe  
T +49 721 56910  
[germanysales@schaffner.com](mailto:germanysales@schaffner.com)

### India

#### Schaffner India Pvt. Ltd

REGUS WORLD TRADE CENTRE  
WTC, 22nd Floor Unit No 2238, Brigade  
Gateway Campus, 26/1, Dr. Rajkumar Road  
Malleshwaram (W)  
560055 Bangalore  
T +91 80 67935355  
[indiasales@schaffner.com](mailto:indiasales@schaffner.com)

### Italy

#### Schaffner EMC S.r.l.

Via Ticino, 30  
20900 Monza (MB)  
T +39 039 21 41 070  
[italysales@schaffner.com](mailto:italysales@schaffner.com)

### Japan

#### Schaffner EMC K.K.

Taiju-Seimei Sangenjaya Bldg.  
1-32-12, Kamiyuma, Setagaya-ku  
154-0011 Tokyo  
T +81 3 5712 3650  
F +81 3 5712 3651  
[japansales@schaffner.com](mailto:japansales@schaffner.com)  
[www.schaffner.jp](http://www.schaffner.jp)

### Singapore

#### Schaffner EMC Pte Ltd.

#05-09, Kg Ubi Ind. Estate  
408705 Singapore  
T +65 6377 3283  
F +65 6377 3281  
[singaporesales@schaffner.com](mailto:singaporesales@schaffner.com)

### Spain

#### Schaffner EMC España

Calle Caléndula 93, Miniparc III, Edificio E  
El Soto de Moraleja, Alcobendas  
28109 Madrid  
T +34 917 912 900  
F +34 917 912 901  
[spainsales@schaffner.com](mailto:spainsales@schaffner.com)

### Sweden

#### Schaffner EMC AB

Östermalmstorg 1  
114 42 Stockholm  
T +46 8 5050 2425  
[swedensales@schaffner.com](mailto:swedensales@schaffner.com)  
[www.schaffner.com](http://www.schaffner.com)

### Switzerland

#### Schaffner EMV AG

Industrie Nord  
Nordstrasse 11e  
4542 Luterbach  
T +41 32 681 66 88  
T +41 32 681 66 26  
[switzerlandsales@schaffner.com](mailto:switzerlandsales@schaffner.com)

### Taiwan

#### Schaffner EMV Ltd.

20 Floor-2, No 97, Section 1, XinTai 5th Road  
22175 XiZhi District New Taipei City 22175  
T +886 2 2697 5500  
F +886 2 2697 5533  
[taiwansales@schaffner.com](mailto:taiwansales@schaffner.com)  
[www.schaffner.com.tw](http://www.schaffner.com.tw)

### Thailand

#### Schaffner EMC Co. Ltd.

Northern Region Industrial Estate  
67 Moo 4 Tambon Ban Klang  
Amphur Muangng P.O. Box 14  
51000 Lamphun  
T +66 53 58 11 04  
F +66 53 58 10 19  
[thailandsales@schaffner.com](mailto:thailandsales@schaffner.com)

### United Kingdom

#### Schaffner Ltd.

1, Oakmede Place  
Binfield  
RG42 4JF Berkshire  
T +44 118 9770070  
F +44 118 9792969  
[uksales@schaffner.com](mailto:uksales@schaffner.com)

### USA

#### Schaffner EMC Inc.

52 Mayfield Avenue  
Edison, New Jersey  
T +1 732 225 9533  
F +1 732 225 4789  
[usasales@schaffner.com](mailto:usasales@schaffner.com)  
[www.schaffnerusa.com](http://www.schaffnerusa.com)

To find your local partner within Schaffner's global network: [www.schaffner.com](http://www.schaffner.com)

© 2022 Schaffner Group

The content of this document has been carefully checked and understood. However, neither Schaffner nor its subsidiaries assume any liability whatsoever for any errors or inaccuracies of this document and the consequences thereof. Published specifications are subject to change without notice. Product suitability for any area of application must ultimately be determined by the customer. In all cases, products must never be operated outside their published specifications. Schaffner does not guarantee the availability of all published products. This disclaimer shall be governed by substantive Swiss law and resulting disputes shall be settled by the courts at the place of business of Schaffner Holding AG. Latest publications and a complete disclaimer can be downloaded from the Schaffner website. All trademarks recognized.