



650V/ 20A Silicon Carbide Power Schottky Barrier Diode

Features

- Rated to 650V at 20 Amps
- Zero reverse recovery current
- Zero forward recovery voltage
- Temperature independent switching behaviour
- High temperature operation
- High frequency operation

Key Characteristics		
V_{RRM}	650	V
$I_F, T_c \leq 150^\circ\text{C}$	20	A
Q_c	56	nC

Benefits

- Unipolar rectifier
- Substantially reduced switching losses
- No thermal run-away with parallel devices
- Reduced heat sink requirements

Applications

- SMPS, e.g., CCM PFC;
- Motor drives, Solar application, UPS,
Wind turbine, Rail traction, EV/HEV

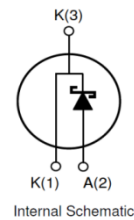
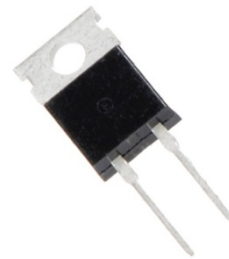

Part No.	Package Type	Marking
G3S06520A	TO-220AC	G3S06520A

Maximum Ratings

Parameter	Symbol	Test Condition	Value	Unit
Repetitive Peak Reverse Voltage	V_{RRM}		650	V
Surge Peak Reverse Voltage	V_{RSM}		650	
DC Blocking Voltage	V_{DC}		650	
Continuous Forward Current	I_F	$T_C=25^{\circ}C$ $T_C=125^{\circ}C$ $T_C=150^{\circ}C$	56.5 31 20	A
Repetitive Peak Forward Surge Current	I_{FRM}	$T_C=25^{\circ}C$, $t_p=10ms$, Half Sine Wave, $D=0.3$	100	A
Non-repetitive Peak Forward Surge Current	I_{FSM}	$T_C=25^{\circ}C$, $t_p=10ms$, Half Sine Wave	175	A
Power Dissipation	P_{TOT}	$T_C=25^{\circ}C$	203	W
		$T_C=110^{\circ}C$	88	W
Operating Junction	T_j		-55°C to 175°C	°C
Storage Temperature	T_{stg}		-55°C to 175°C	°C
Mounting Torque		M3 Screw	1	Nm
		6-32 Screw	8.8	lbf-in

Thermal Characteristics

Parameter	Symbol	Test Condition	Value	Unit
			Typ.	
Thermal resistance from junction to case	$R_{th JC}$		0.74	°C/W

Electrical Characteristics

Parameter	Symbol	Test Conditions	Numerical		Unit
			Typ.	Max.	
Forward Voltage	V_F	$I_F=20A, T_j=25^\circ C$	1.52	1.7	V
		$I_F=20A, T_j=175^\circ C$	1.8	2.5	
Reverse Current	I_R	$V_R=650V, T_j=25^\circ C$	10	50	μA
		$V_R=650V, T_j=175^\circ C$	20	100	
Total Capacitive Charge	Q_C	$V_R=400V, T_j=150^\circ C$ $Q_C = \int_0^{V_R} C(V)dV$	56	-	nC
Total Capacitance	C	$V_R=0V, T_j=25^\circ C, f=1MHz$	1170	1300	pF
		$V_R=200V, T_j=25^\circ C, f=1MHz$	110	120	
		$V_R=400V, T_j=25^\circ C, f=1MHz$	100	108	

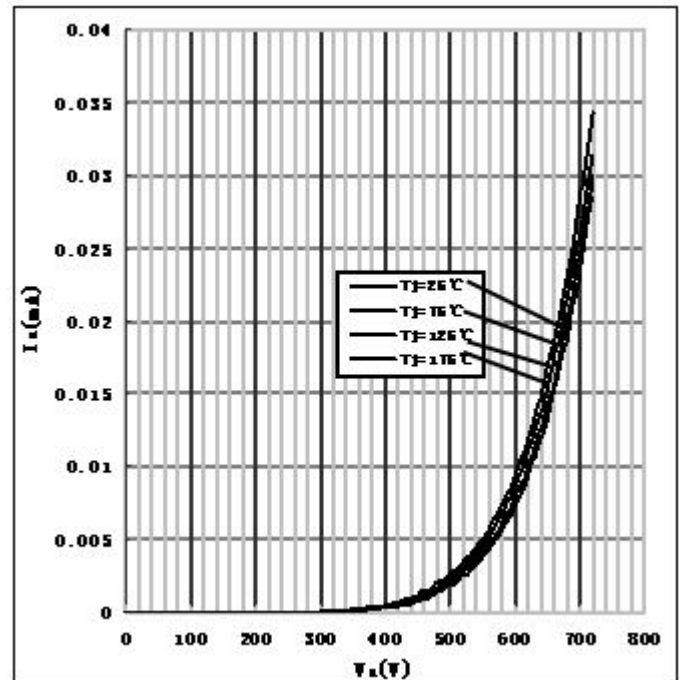
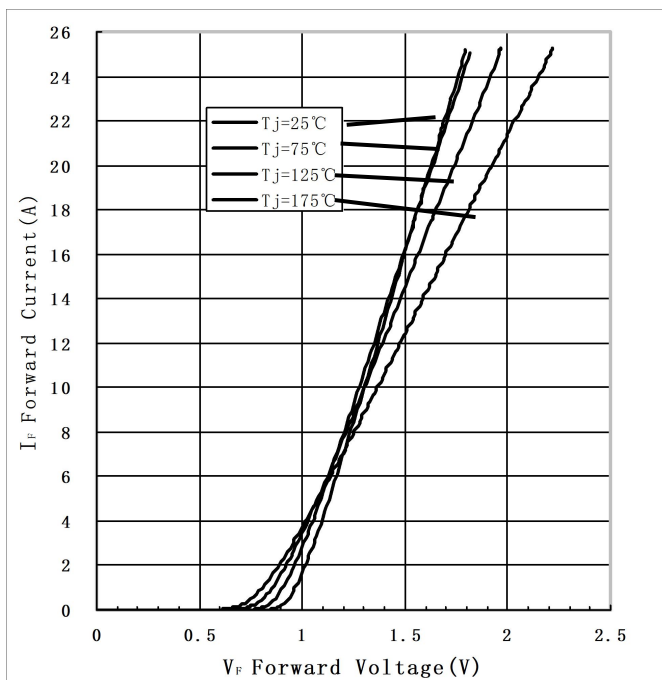
Performance Graphs1) Forward IV characteristics as a function of T_j :2) Reverse IV characteristics as a function of T_j :

3) Current Derating

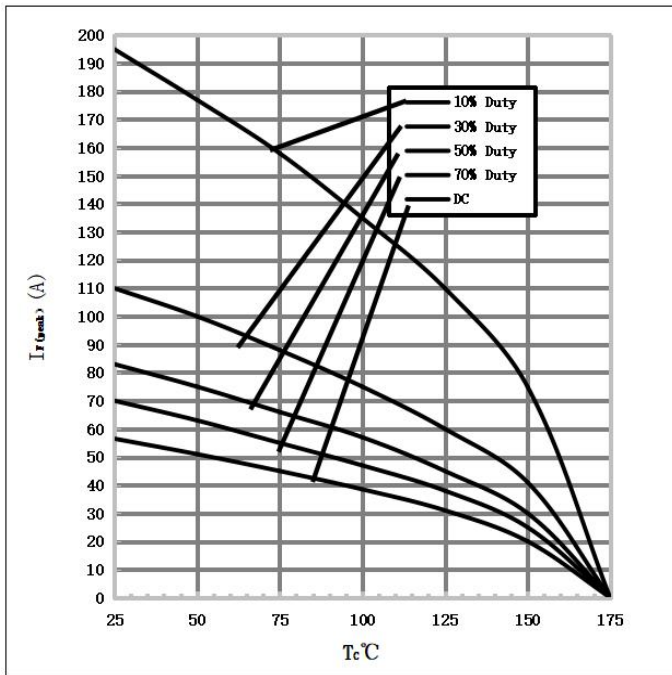

4) Capacitance vs. reverse voltage :

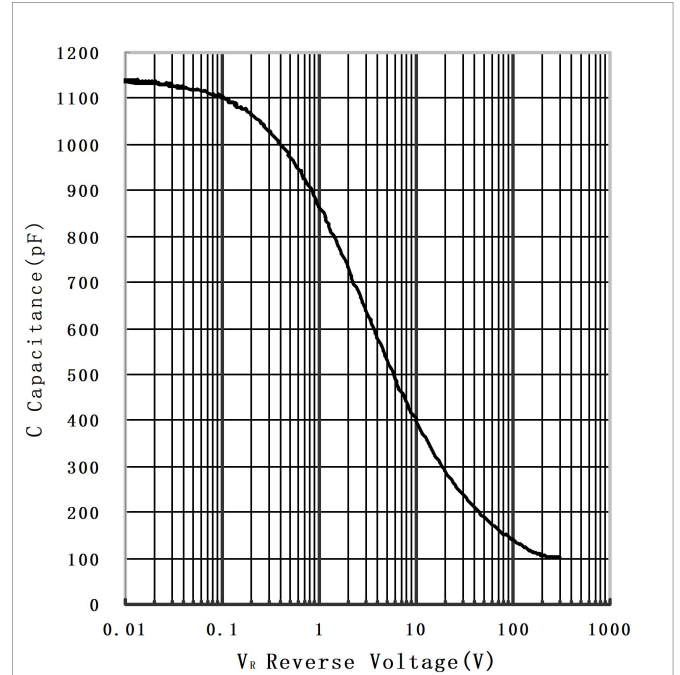

Package TO-220AC

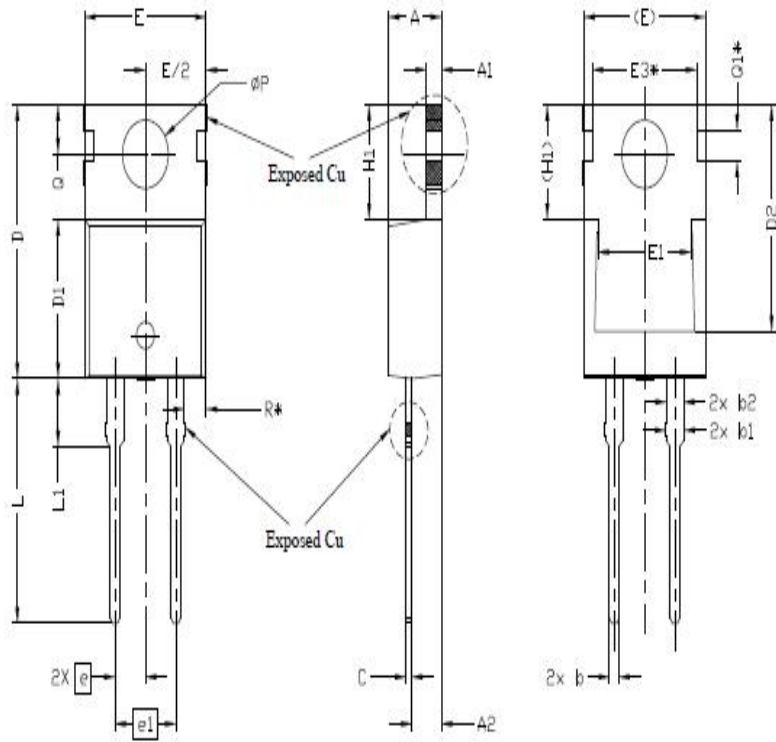

SYMBOL	DIMENSIONS			NOTES
	MIN.	NOM.	MAX.	
A	4.24	4.44	4.64	
A1	1.15	1.27	1.40	
A2	2.30	2.48	2.70	
b	0.70	0.80	0.90	
b1	1.20	1.55	1.75	
b2	1.20	1.45	1.70	
c	0.40	0.50	0.60	
D	14.70	15.37	16.00	4
D1	8.82	8.92	9.02	
D2	12.63	12.73	12.83	5
E	9.96	10.16	10.36	4,5
E1	6.86	7.77	8.89	5
E3*	8.70REF.			
e	2.54BSC			
e1	5.08BSC			
H1	6.30	6.45	6.60	5,6
L	13.47	13.72	13.97	
L1	3.60	3.80	4.00	
Q	2.60	2.80	3.00	
Q1*	1.73REF.			
R*	1.82REF.			

Note: The levels of RoHS restricted materials in this product are below the maximum concentration values (also referred to as the threshold limits) permitted for such substances, or are used in an exempted application, in accordance with EU Directive 2011/65/EC(RoHS2). RoHS Certification and other certifications can be obtained from GPT sales representatives or GPT website: <http://globalpowertech.cn/English/index.asp>

More product datasheets and company information can be found in:

<http://globalpowertech.cn/English/index.asp>

