

ALL DIMENSIONS IN INCHES

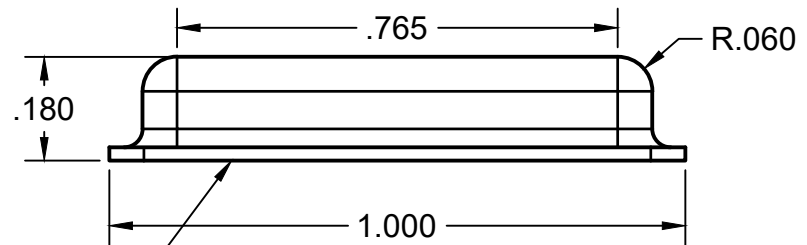

Pressure-Sensitive Adhesive

Nominal web thickness = 0.030"

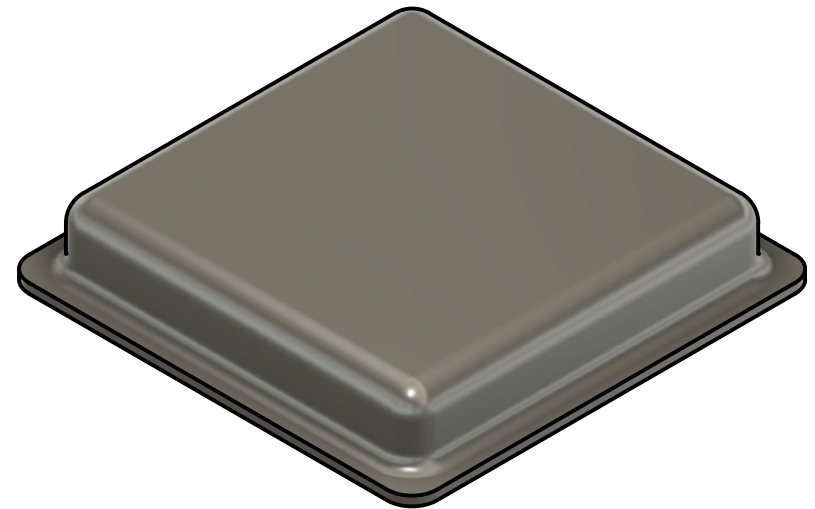
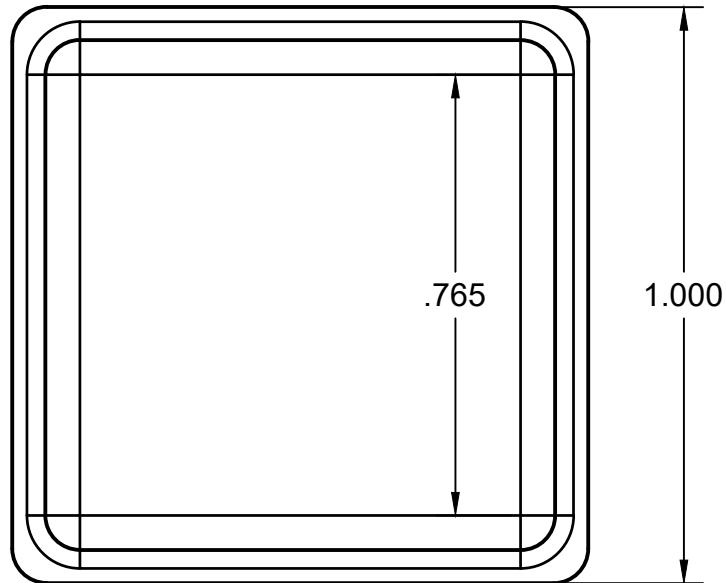

**MADE IN
THE USA**

COMPANY
 Bumper Specialties, Inc.
 1607 Imperial Way, West Deptford, NJ 08066
 (856)-345-7650
 www.BumperSpecialties.com

TOLERANCE ± 0.020"	DUROMETER, SHORE A 60-70 Standard	MATERIAL Polyurethane
PART NO BS36	DRAWN 11/11/19	REV 1
SHEET 1 of 1		