

DSO221SR TYPE SPXO SPECIFICATION

1. Device Name SPXO
2. Type DSO221SR
3. Frequency 32.768 kHz
4. Output Level CMOS
5. Absolute Maximum Value

	Item	Symbol	Rating	Unit
1	Supply Voltage	V _{cc}	-0.5 ~ +7.0	V
2	Storage Temperature Range	T _{stg}	-40 ~ +85	°C

6. Recommended Operating Conditions

	Item	Symbol	min.	typ.	max.	Unit
1	Supply Voltage	V _{cc}	+3.0	+3.3	+3.6	V
2	Operating Temperature Range	T _{use}	-40	-	+85	°C
3	Load Resistance	L _{CMOS}	-	-	15	pF

7. Electrical Characteristics

(T_a = +25°C, V_{cc} = +3.3V, unless otherwise noted)

	Item	Symbol	Test Conditions	Limits			Unit
				min.	typ.	max.	
1	Frequency Tolerance	f _{tol}	V _{cc} = +3.3 ± 0.3V T _a = -40 ~ +85 °C	-50	-	+50	ppm
2	Current Consumption	I _{cc}	at No Load, #1pin: "H" or open	-	-	65	μA
3	Standby Current	I _{std}	#1pin: "L"	-	-	3	μA
4	Output Character		15pF				
	1.Symmetry	SYM	0.5V _{cc} level	45	50	55	%
	2.Rise Time	t _r	0.1V _{cc} ~ 0.9V _{cc}	-	-	20	ns
	3.Fall Time	t _f	0.9V _{cc} ~ 0.1V _{cc}	-	-	20	ns
	4.Low Level	V _{OL}		-	-	V _{cc} * 0.1	V
	5.High Level	V _{OH}		V _{cc} * 0.9	-	-	V
5	Input OE						
	1.Output enable time	t _{PZL}		-	-	2	ms
	2.Output disable time	t _{PLZ}		-	-	150	ns
	3.Enable input	V _{IH}		V _{cc} * 0.7	-	-	V
	4.Disable input	V _{IL}		-	-	V _{cc} * 0.3	V

*Fig1. Measurement Circuits

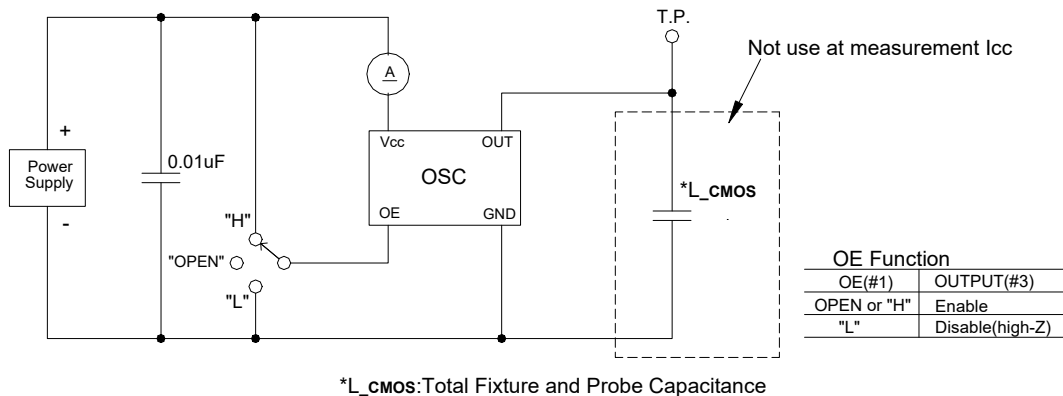

Date	Spec.No	Rev.	Remark	Page.
2022/05/30	7FE00003A17	-	S22-009	1/2

DSO221SR TYPE SPXO SPECIFICATION

* Fig2. Output Waveform

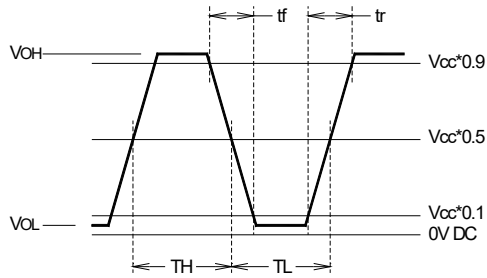

$$SYM = \frac{TH}{TL+TH} * 100 (\%)$$

* Fig3. Input output condition

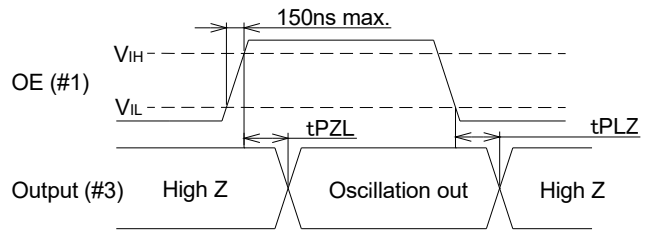

8. Outline, Pin Connections

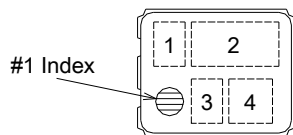
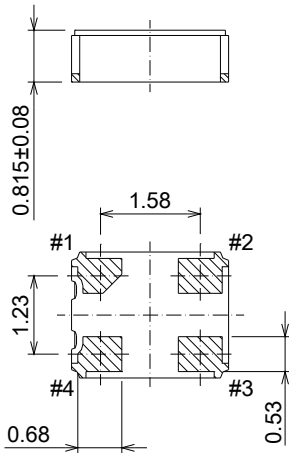
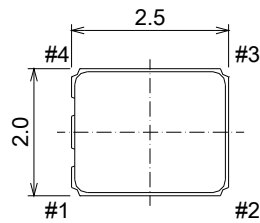

Pin Connections

Pin No.	Connection
#1	OE(Output Enable)
#2	GND
#3	Output
#4	Vcc

Tolerance: ±0.15

unit: mm

(Land Pattern (Reference)) <Top View>

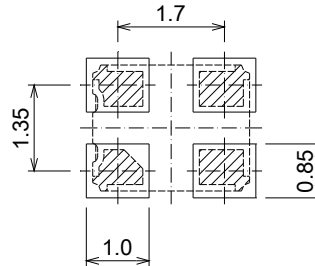

- 1.Type : R
- 2.Nominal Frequency : 0.03
- 3.KDS LOGO(D)
- 4.Lot No. : Year (1digit)+Week (2digits)
e.g. 2020/1/1 → 001

Date	Spec.No	Rev.	Remark	Page.
2022/05/30	7FE00003A17	-	S22-009	2/2