



MW Components

Product Line Catalog



Order online
Download CAD drawings
rafhdwe.com

Threaded inserts
Precision machined products
Compression limiters
Knurled spacers



RAF Electronic Hardware

Every year your industry grows more competitive. Products are manufactured faster, cheaper, better. Demands are greater, and your customers' requirements are continually changing. What doesn't change is your need for a reliable, competent source for threaded inserts and precision machined products. At RAF Electronic Hardware, we want to be that source, and we will work hard to earn and maintain your confidence in us.

What is important to you is important to us. At RAF, our top priority is Total Customer Satisfaction. Our program emphasizes:

- **Quality** – We are registered to ISO 9001.
- **On-time Delivery** – Most orders for stock items ship the same day. We are proud that, year after year, we average greater than 98.5% on-time delivery.
- **Competitive Pricing** – Our experienced personnel, the most advanced equipment and highly efficient production methods, combined with blanket order programs, cumulative pricing plans and low minimums, ensure the best price possible for every order.
- **Customer Service** – Our conscientious staff is committed to providing a prompt, courteous response to every customer request. In addition, RAF's extensive database is used by every department, assuring that all certification, packaging and labeling requirements are met.
- **Application Engineering** - With our expertise in design engineering, plastics and the manufacturing process, we are unsurpassed in the design of cost-effective alternatives for special applications.

We invite you to rely on RAF for the threaded inserts and precision machined products that will help you stay competitive and profitable. We want your business. From design to delivery, we will focus on your total satisfaction.

Let us prove it to you.

MW Industries, Inc. (MWI) is one of the world's premier manufacturers of products that make machines, engines, and complex sub-assemblies work harder, better, longer, and faster. Our full line of industrial springs, fasteners, machined parts, and flat-stamped spring-related products are engineered for peak performance and made from the world's best materials. Innovation and value are the linchpins of our company. Our manufacturing capabilities and reputation for high-quality products and customer service are unmatched in this industry, which helps make us your one-stop shop for all your industrial manufacturing needs.

We are the largest and most diversified precision metal-based components manufacturer in the United States. Across a broad range of industries and applications, we have the right solutions for your difficult technical changes. We've earned a reputation for - and built our business on - delivering the technological innovations that become the strength, speed, and durability you need in your applications.



MW Industries

Corporate Headquarters

3426 Toringdon Way, Suite 100
Charlotte, NC 28277
Sales: 704.280.8875
General: 704.837.0331
sales@mwcomponents.com
mwcomponents.com

ISO 9001 Certified. ©2021 MW Industries

What are inserts?

Inserts are used to strengthen plastic parts in which screws are to be installed and removed more than once. Most are made of brass, which provides long thread life as well as a solid, secure fastening base. Ours are also available in aluminum, stainless steel and free-machining steel by special order.

Inserts are commonly used to reinforce two types of plastic: Thermoplastic or Thermoset Plastic. Thermoplastics are like wax. At usable temperatures they are solid, but at elevated temperatures they get soft and melt. In contrast, thermoset plastics have

a molecularly cross-linked structure which is permanently "set" into shape during the manufacturing process.

Thermoplastic compounds are generally more resilient than thermosets and respond well to the ultrasonic or thermal installation of inserts. Thermoset compounds, however, are often brittle and less resilient than thermoplastics. They respond better to molding or post-molding cold insertion.

Our inserts come in a variety of styles and sizes to meet a variety of applications. They are manufactured to the following thread specifications: UNC-2B and UNF-2B for inch threads and ISO-6H for metric threads.

Installation methods

Insert Molding: Molding an insert into an assembly increases the total molding time because extra time is needed to load the insert. Molded-in inserts may also cause sink marks. They are widely used with thermoset (non-meltable) plastics.

Post-molded: Post-molded inserts eliminate the downtime associated with molding a thread or an insert into a plastic part, such as die damage caused by improper placement. Advantages include faster assembly, reduced open press time and no sink marks.

Ultrasonic: The most common method for installing inserts into thermoplastic materials, it provides fast, positive anchoring. An insert is placed in a molded or drilled hole which guides it and provides resistance. An ultrasonic horn contacts the insert and delivers ultrasonic vibrations which travel through the insert during the "weld cycle." Frictional heat is immediately developed which melts the plastic as the horn drives the insert into position. After the vibrations cease, the equipment applies clamp pressure until the plastic cools, preventing back-out.

Thermal: During thermal/heat insertion, the insert is placed into a molded or drilled hole. Pressure is applied with a heated probe that contacts the top surface and minor thread diameter of the insert. Localized melting takes place, and plastic flows in and around the knurls and serrations. When the proper depth is reached, the probe is removed and the plastic re-solidifies, locking the insert in place. Upon removal of the probe, a minimal amount of withdrawal (back-out) of the insert may occur. Thermal/heat insertion provides a good alternative to the ultrasonic method, but it is a slower process. Some benefits include:

- Multiple inserts can be installed simultaneously, even on different levels
- Quiet when compared to ultrasonic
- Thermal equipment is less expensive than ultrasonic equipment
- Excellent for larger inserts

Cold Insertion: Some inserts can simply be pressed in after molding. However, pressing inserts into cold plastic may create unwanted stress. Larger boss (or wall thicknesses) are required to prevent stress fracture. Pull, torque and jack-out strengths are significantly lower compared to thermal or ultrasonic installation.

Variables to consider

Lubricants, Fillers or Glass in the Plastic: If the plastic's filler or glass content exceeds 40%, assembly or performance problems may result.

Molded Versus Drilled Holes: Molded holes provide better performance than drilled holes because a strong skin of denser material is formed around them during molding. This is particularly true with structural foam plastics which are porous under the skin.

Plating and Color-coding: We offer a full range of plating and/or color-coding services. The most common metal finishes include nickel, tin and zinc. Inserts of similar size and configuration are often color-coded to prevent inadvertent mixing (inch threads vs. metric threads).

Insert Selection Guide

Page

6-7



H Series Tapered Inserts

The leading insert for ultrasonic or thermal installation into thermoplastic or structural foam. A row of unique “knuckle knurls” reduces residual stress and increases strength. The tapered design reduces installation time, making alignment faster and more accurate.

8-9



C Series Chevron Inserts

Designed for straight holes using ultrasonic or thermal processes. This series features two opposing bands of sharp diagonal knurls of different diameters for maximum gripping power. A lead-in pilot diameter assures true perpendicular alignment.

10



HC Series Headed Chevron Inserts

The HC Series features a flange for a greater load-bearing surface in weaker plastics. The flange provides a large contact area for electrical connections. Used in reverse-entry applications, the HC Series offers exceptional pull-out strengths.

11



S Series Symmetrical Inserts

For fast, high-volume applications, symmetrical inserts install without orientation using ultrasonic or thermal equipment. They are designed for straight holes and are ideal for thin-wall applications because little stress is applied to the walls of the part.

12



P & HP Series Press-in Inserts

Straight-hole inserts install easily in hard or thermoset plastics without heat or special equipment. Three bands of helical knurls anchor the insert firmly into place and provide excellent torque-out resistance.

13



E & HE Series Expansion Inserts

Designed to provide strong, usable threads in thermoset and other hard plastics. The inserts are pressed into the plastic and expand when the assembly screw is installed. The sharp diamond knurls secure them into the plastic. Inserts are available with or without a flange.

14-15



SH & SC Series Threaded Studs

Available in H or C Series body designs. Studs are commonly used to fulfill specific design functions, to save money in production costs, to function as electrical contacts or to replace self-tapping or removable screws. Thread lengths are variable to meet your specific requirements. Special studs without threads can be used as axles, pivots, pins, locating points or solder terminals.

16



MB Series Mold-in Blind Inserts & RM Series Rotational Mold-in Blind Inserts

Designed for mold-in applications. The inserts feature a blind thread (closed bottom) that prevents plastic from entering the bottom of the insert. The hex design of the rotational molded insert provides greater holding power in softer materials.

16



KS Series Knurled Spacers, Threaded

Designed for a wide variety of applications, these inserts are commonly used for stacking printed circuit boards or when a threaded spacer is required. They can also be molded into a plastic component.

16



CL Series Compression Limiters

Unthreaded spacers (bushings) used to strengthen plastics during compression loads. These types of loads are generated when fastening bolts and screws during assembly. Compression limiters can be designed for any installation method.

17



Specials & Custom Designed Parts

Our design engineers will be happy to adapt an existing insert or custom design one specifically for your application. And you'll be surprised how quickly we get back to you.

Boss diameter/wall thickness

When designing a mating component clearance hole, it is very important that the insert, not the plastic, carries the load. The hole in the mating component should be larger than the outside thread diameter of the screw and smaller than the insert diameter. This prevents the insert from jacking out (Figure 1). When the mating component hole is larger than the insert diameter, a jack-out condition exists (Figure 2).

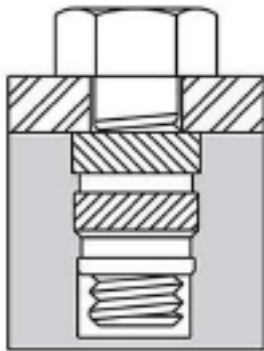

Figure 1
Correct

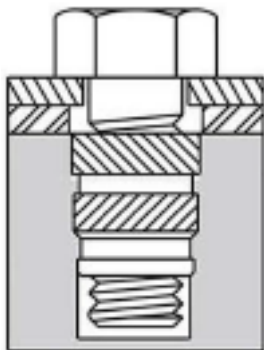

Figure 2
Incorrect

Design considerations

- Hole sizes are not core pin sizes.
- Core pins should be designed to allow for the shrinking of plastic.
- For solid (blind) inserts and threaded studs, we recommend adding a small vent at the bottom of the hole to allow trapped air and other gasses to escape.
- Expect your inserts to seat flush with or .005" above the plastic surface.

The performance value of an insert is proportional to the wall thickness (boss diameter) surrounding it. When an increase in wall thickness does not produce an increase in performance, optimum thickness has been reached. Optimum thickness, on average, is two times the hole diameter. If a boss is too large, a sharp drop in performance may result because the hole may become oversized as the molded plastic shrinks. When the hole diameter is larger than recommended, less material is displaced and the insert does not become fully encapsulated in the plastic part - resulting in lower performance values.

Hole specifications

Hole depth is the key to achieving a flush installation and preventing excess plastic from forming on the threads at the bottom of the insert. Countersinks should not be molded into a hole where an insert is to be installed.

All of our inserts have a pilot or "lead-in" diameter that assures proper alignment of the insert during installation, as well as a counterbore or countersink at each end of the insert for easy installation of the mating screw.

Should alterations in hole sizes be necessary, please contact our Engineering Department for technical assistance.

Remember, there are two types of molded holes referred to in this catalog.

The "straight hole" has a maximum of a 1° taper or 1/2° per side. The "tapered hole" has an approximate 8° included angle.

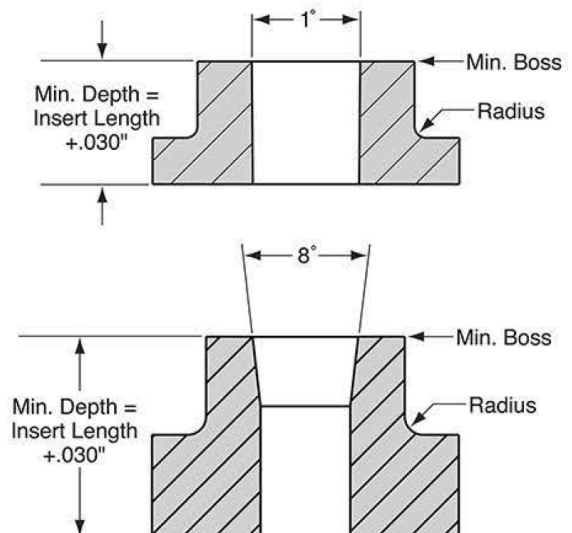

H Series Tapered Inserts



H Series Long

Superior in design and performance

H Series Tapered Inserts outperform all competitive inserts for ultrasonic and thermal applications. Our customers confirm it.

We've eliminated the outward stress that occurs with other insert designs during the installation process. Our proprietary "knuckle knurl" ensures a more uniform flow of material into the diagonal knurls and undercuts, ensuring a complete fill, reducing installation time and increasing holding strengths.

Recommended Hole Size - See chart for installation hole size.
Additional information can be found on page 5, Design Guidelines.



H Series Short

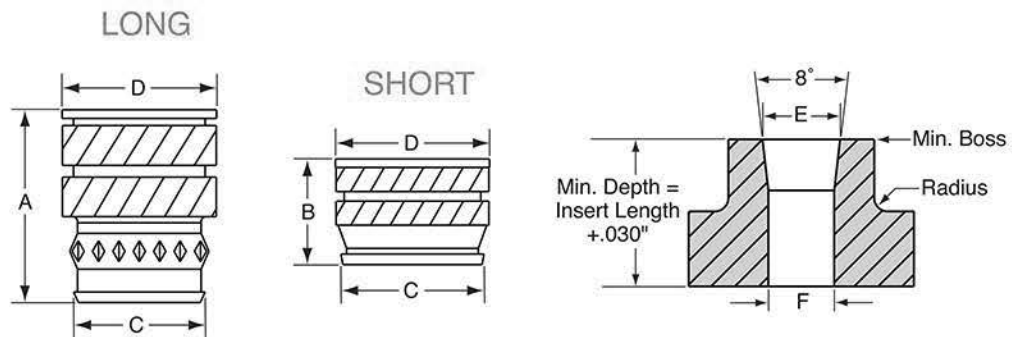

INCH		METRIC		A	B	C	D	E	F	Min. Boss
Thread Size	Part Number	Thread Size	Part Number	±.004 [long]	±.004 [short]	±.004	±.004	+0.002 -0.000	+0.002 -0.000	
0-80	080 x 115H	M1.6 x 0.35	M16 x 115H		.115	.123	.141	.129	.118	.246
	080 x 188H		M16 x 188H	.188		.112	.141	.123	.107	.246
2-56	256 x 115H	M2.0 x 0.4	M20 x 115H		.115	.123	.141	.129	.118	.246
	256 x 188H		M20 x 188H	.188		.112	.141	.123	.107	.246
4-40	440 x 135H	M2.5 x 0.45	M25 x 135H		.135	.157	.172	.159	.153	.318
	440 x 219H		M25 x 219H	.219		.146	.172	.159	.141	.318
	440 x 285H		M25 x 285H	.285		.146	.172	.159	.141	.318
5-40	540 x 150H	M3.0 x 0.5	M30 x 150H		.150	.203	.219	.206	.199	.412
	540 x 250H		M30 x 250H	.250		.190	.219	.206	.185	.412
6-32	632 x 150H	M3.5 x 0.6	M35 x 150H		.150	.203	.219	.206	.199	.412
	632 x 250H		M35 x 250H	.250		.190	.219	.206	.185	.412
8-32	832 x 185H	M4.0 x 0.7	M40 x 185H		.185	.230	.250	.234	.226	.468
	832 x 312H		M40 x 312H	.312		.213	.250	.234	.208	.468
	832 x 375H		M40 x 375H	.375		.213	.250	.234	.208	.468

continued on next page

H Series Tapered Inserts

INCH		METRIC		A	B	C	D	E	F	Min. Boss
Thread Size	Part Number	Thread Size	Part Number	±.004 [long]	±.004 [short]	±.004	±.004	+ .002 - .000	+ .002 - .000	
10-24	1024 x 150H				.150	.267	.297	.277	.267	.554
	1024 x 225H				.225	.272	.297	.277	.267	.554
	1024 x 375H			.375		.251	.297	.277	.246	.554
10-32	1032 x 150H				.150	.267	.297	.277	.267	.554
	1032 x 225H				.225	.272	.297	.277	.267	.554
	1032 x 375H			.375		.251	.297	.277	.246	.554
		M5.0 x 0.8	M50 x 265H		.265	.308	.328	.315	.303	.630
			M50 x 438H	.438		.283	.328	.315	.278	.630
1/4-20	2520 x 300H				.300	.354	.375	.363	.349	.726
	2520 x 500H			.500		.332	.375	.363	.321	.726
1/4-28	2528 x 300H	M6.0 x 1.0	M60 x 300H		.300	.354	.375	.363	.349	.726
	2528 x 500H		M60 x 500H	.500		.332	.375	.363	.321	.726
5/16-18	3118 x 335H				.335	.439	.469	.448	.431	.896
	3118 x 562H			.562		.406	.469	.448	.401	.896
5/16-24	3124 x 335H	M8.0 x 1.25	M80 x 335H		.335	.439	.469	.448	.431	.896
	3124 x 562H		M80 x 562H	.562		.406	.469	.448	.401	.896
3/8-16	3816 x 375H				.375	.532	.563	.540	.523	1.080
	3816 x 625H			.625		.493	.563	.540	.488	1.080
3/8-24	3824 x 375H	M10.0 x 1.5	M100 x 375H		.375	.532	.563	.540	.523	1.080
	3824 x 625H		M100 x 625H	.625		.493	.563	.540	.488	1.080

Stainless Steel Inserts - Class 3A/4H screw must pass with finger torque, standard class go gage may stop on last thread. Part numbers for Stainless Steel Inserts are the same as listed in the chart, but ending with - SS.

Thread sizes of 0-80, 2-56, M1.6 and M2.0 in H Series Inserts have a single diamond knurl.

C Series Chevron Inserts

Most popular, most overall length choices



C Series Chevron

Some thermoplastics, like polycarbonates and structural foams, are brittle – especially in thin-wall applications. Our chevron inserts add considerable strength.

Two opposing bands of sharp diagonal knurls provide high tensile pull-out load carrying capability. Little or no stress is applied to the walls of the molded holes.

Recommended Hole Size - See chart for installation hole size.
Additional information can be found on page 5, Design Guidelines.

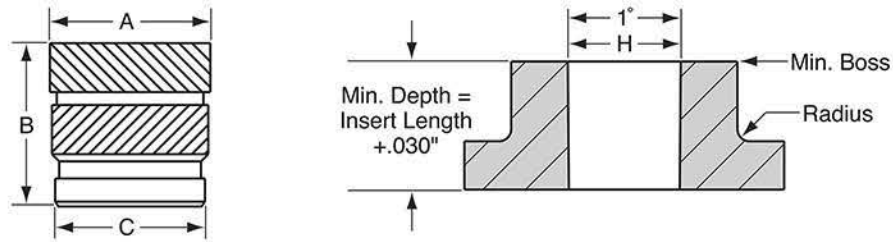

INCH		METRIC		A	B	C	Hole H	Min. Boss
Thread Size	Part Number	Thread Size	Part Number	±.004	±.004	±.004	+.003 –.000	
2-56	256 x 100C	M2.0 x 0.4	M20 x 100C	.143	.100	.123	.126	.252
	256 x 125C	M2.0 x 0.4	M20 x 125C	.143	.125	.123	.126	.252
	256 x 157C	M2.0 x 0.4	M20 x 157C	.143	.157	.123	.126	.252
4-40	440 x 135C	M2.5 x 0.45	M25 x 135C	.186	.135	.154	.157	.314
		M3.0 x 0.5	M30 x 135C	.186	.135	.154	.157	.314
	440 x 157C	M2.5 x 0.45	M25 x .157C	.186	.157	.154	.157	.314
		M3.0 x 0.5	M30 x 157C	.186	.157	.154	.157	.314
	440 x 170C	M2.5 x 0.45	M25 x 170C	.186	.170	.154	.157	.314
		M3.0 x 0.5	M30 x 170C	.186	.170	.154	.157	.314
	440 x 226C	M3.0 x 0.5	M30 x 197C	.186	.197	.154	.157	.314
		M2.5 x 0.45	M25 x 226C	.186	.226	.154	.157	.314
6-32	632 x 125C	M3.0 x 0.5	M30 x 226C	.186	.226	.154	.157	.314
		M3.5 x 0.6	M35 x 226C	.186	.226	.154	.157	.314
	632 x 150C	M3.0 x 0.5	M30 x 250C	.218	.125	.185	.188	.376
		M3.5 x 0.6	M35 x 150C	.218	.150	.185	.188	.376
	632 x 226C	M3.0 x 0.5	M30 x 250C	.218	.125	.185	.188	.376
		M3.5 x 0.6	M35 x 250C	.218	.150	.185	.188	.376
632 x 281C	M3.5 x 0.6	M35 x 281C	.218	.281	.185	.188	.376	

continued on next page

C Series Chevron Inserts

INCH		METRIC		A	B	C	Hole H	Min. Boss
Thread Size	Part Number	Thread Size	Part Number	±.004	±.004	±.004	+ .003 – .000	
8-32	832 x 185C	M4.0 x 0.7	M40 x 185C	.249	.185	.218	.221	.442
	832 x 250C		M40 x 250C	.249	.250	.218	.221	.442
	832 x 321C		M40 x 321C	.249	.321	.218	.221	.442
10-24	1024 x 185C	M5.0 x 0.8	M50 x 185C	.280	.185	.249	.252	.504
	1024 x 225C		M50 x 225C	.280	.225	.249	.252	.504
	1024 x 250C		M50 x 250C	.280	.250	.249	.252	.504
	1024 x 310C		M50 x 310C	.280	.310	.249	.252	.504
	1024 x 375C		M50 x 375C	.280	.375	.249	.252	.504
10-32	1032 x 185C			.280	.185	.249	.252	.504
	1032 x 225C			.280	.225	.249	.252	.504
	1032 x 250C			.280	.250	.249	.252	.504
	1032 x 310C			.280	.310	.249	.252	.504
	1032 x 375C			.280	.375	.249	.252	.504
1/4-20	2520 x 226C	M6.0 x 1.0	M60 x 226C	.342	.226	.312	.315	.630
	2520 x 250C		M60 x 250C	.342	.250	.312	.315	.630
	2520 x 312C		M60 x 312C	.342	.312	.312	.315	.630
	2520 x 375C		M60 x 375C	.342	.375	.312	.315	.630
	2520 x 500C		M60 x 500C	.342	.500	.312	.315	.630
1/4-28	2528 x 226C			.342	.226	.312	.315	.630
	2528 x 250C			.342	.250	.312	.315	.630
	2528 x 312C			.342	.312	.312	.315	.630
	2528 x 375C			.342	.375	.312	.315	.630
	2528 x 500C			.342	.500	.312	.315	.630
5/16-18	3118 x 250C	M8.0 x 1.25	M80 x 250C	.406	.250	.374	.377	.754
	3118 x 500C		M80 x 500C	.406	.500	.374	.377	.754
5/16-24	3124 x 250C			.406	.250	.374	.377	.754
	3124 x 500C			.406	.500	.374	.377	.754
3/8-16	3816 x 500C	M10.0 x 1.5	M100 x 500C	.498	.500	.465	.468	.936
3/8-24	3824 x 500C			.498	.500	.465	.468	.936
1/2-13	5013 x 625C			.659	.625	.623	.627	1.254
1/2-20	5020 x 625C							

Stainless Steel Inserts - Class 3A/4H screw must pass with finger torque, standard class go gage may stop on last thread. • Part numbers for Stainless Steel Inserts are the same as listed in the chart, but ending with -SS.

HC Series Chevron Inserts

Straight hole flanged / headed

HC Series Inserts offer the same benefits as the C Series plus a flanged head. This insert offers a large contact area for electrical connections and greater pullout strengths for reverse entry applications.

Recommended Hole Size - See chart for installation hole size.
Additional information can be found on page 5, Design Guidelines.



HC Series
Chevron

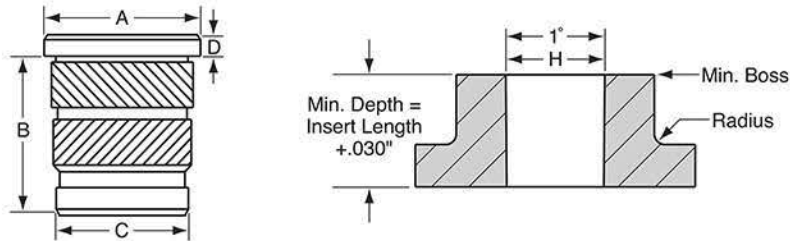

INCH		METRIC		A	B	C	D	Hole H	Min. Boss
Thread Size	Part Number	Thread Size	Part Number	±.004	±.004	±.004	Flange Thickness	+ .003 - .000	
2-56	H256 x 157C	M2.0 x 0.4	HM20 x 157C	.188	.157	.123	.018	.126	.252
4-40	H440 x 226C	M2.5 x 0.45	HM25 x 226C	.218	.226	.154	.021	.157	.314
		M3.0 x 0.5	HM30 x 226C	.218	.226	.154	.021	.157	.314
6-32	H632 x 180C	M3.5 x 0.6	HM35 x 180C	.250	.180	.185	.027	.188	.376
	H632 x 281C		HM35 x 281C	.250	.281	.185	.027	.188	.376
8-32	H832 x 185C	M4.0 x 0.7	HM40 x 185C	.281	.185	.218	.033	.221	.442
	H832 x 250C		HM40 x 250C	.281	.250	.218	.033	.221	.442
	H832 x 321C		HM40 x 321C	.281	.321	.218	.033	.221	.442
10-24	H1024 x 225C	M5.0 x 0.8	HM50 x 225C	.312	.225	.249	.040	.252	.504
	H1024 x 250C		HM50 x 250C	.312	.250	.249	.040	.252	.504
	H1024 x 375C		HM50 x 375C	.312	.375	.249	.040	.252	.504
10-32	H1032 x 225C			.312	.225	.249	.040	.252	.504
	H1032 x 250C			.312	.250	.249	.040	.252	.504
	H1032 x 375C			.312	.375	.249	.040	.252	.504
1/4-20	H2520 x 300C	M6.0 x 1.0	HM60 x 300C	.375	.300	.312	.050	.315	.630
	H2520 x 500C		HM60 x 500C	.375	.500	.312	.050	.315	.630
1/4-28	H2528 x 300C			.375	.300	.312	.050	.315	.630
	H2528 x 500C			.375	.500	.312	.050	.315	.630
5/16-18	H3118 x 500C	M8.0 x 1.25	HM80 x 500C	.437	.500	.374	.050	.377	.754
5/16-24	H3124 x 500C			.437	.500	.374	.050	.377	.754
3/8-16	H3816 x 500C	M10.0 x 1.5	HM100 x 500C	.550	.500	.465	.065	.468	.936
3/8-24	H3824 x 500C			.550	.500	.465	.065	.468	.936

Stainless Steel Inserts - Class 3A/4H screw must pass with finger torque, standard class go gage may stop on last thread. Part numbers for Stainless Steel Inserts are the same as listed in the chart, but ending with -SS.

S Series Symmetrical Insert

The natural choice for high-volume automatic feeding



S Series
Symmetrical

Say goodbye to expensive part orientation feeding mechanisms. Our symmetrical inserts can be installed either end first for faster installation and lower costs.

By decreasing outward hoop stress, symmetrical inserts decrease cycle times. Their proportionally engineered design ensures that the displaced material is encapsulated by knurls and undercuts. They are designed for straight hole applications.

Recommended Hole Size - See chart for installation hole size.
Additional information can be found on page 5, Design Guidelines.

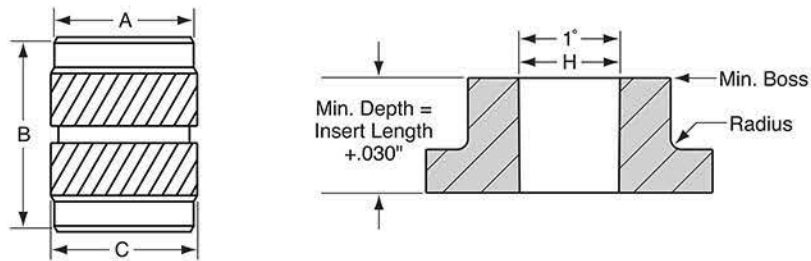

INCH		METRIC		A	B	C	Hole H	Min. Boss
Thread Size	Part Number	Thread Size	Part Number	±.004	±.004	±.004	+ .003 - .000	
2-56	256 x 115S	M2.0 x 0.4	M20 x 115S	.123	.115	.138	.126	.252
	256 x 157S	M2.0 x 0.4	M20 x 157S	.123	.157	.138	.126	.252
4-40	440 x 226S	M2.5 x 0.45	M25 x 226S	.154	.226	.175	.157	.314
		M3.0 x 0.5	M30 x 226S	.154	.226	.175	.157	.314
6-32	632 x 281S	M3.5 x 0.6	M35 x 281S	.185	.281	.206	.188	.376
8-32	832 x 321S	M4.0 x 0.7	M40 x 321S	.218	.321	.239	.221	.442
10-24	1024 x 375S	M5.0 x 0.8	M50 x 375S	.249	.375	.270	.252	.504
10-32	1032 x 375S			.249	.375	.270	.252	.504
1/4-20	2520 x 500S	M6.0 x 1.0	M60 x 500S	.312	.500	.333	.315	.630
1/4-28	2528 x 500S			.312	.500	.333	.315	.630
5/16-18	3118 x 500S	M8.0 x 1.25	M80 x 500S	.374	.500	.393	.377	.754
5/16-24	3124 x 500S			.374	.500	.393	.377	.754
3/8-16	3816 x 500S	M10 x 1.5	M100 x 500S	.465	.500	.484	.468	.936
3/8-24	3824 x 500S			.465	.500	.484	.468	.936

Stainless Steel Inserts - Class 3A/4H screw must pass with finger torque, standard class go gage may stop on last thread.
Part numbers for Stainless Steel Inserts are the same as listed in the chart, but ending with -SS.

P & HP Series Press-in Inserts

P & HP Series inserts provide adequate holding strengths without the use of ultrasonic or heat equipment. These inserts are most commonly used in thermoset or other hard plastics. The pilot end provides for fast alignment. The insert is placed in a hole, pressure is applied and the three bands of helical knurls dig down deep and lock the insert in place.



P Series



HP Series

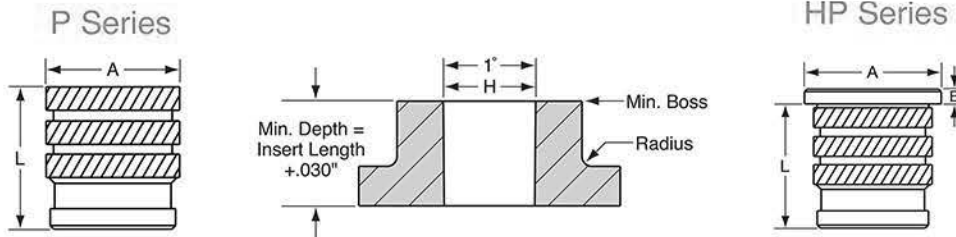

P Series Inserts

INCH		METRIC		A	L	Hole H	Min. Boss
Thread Size	Part Number	Thread Size	Part Number	±.004	±.004	+0.003 - .000	
2-56	256 x 157P	M2.0 x 0.4	M20 x 157P	.134	.157	.121	.242
4-40	440 x 208P	M3.0 x 0.5	M30 x 208P	.165	.208	.150	.300
6-32	632 x 247P	M3.5 x 0.6	M35 x 247P	.197	.247	.182	.364
8-32	832 x 292P	M4.0 x 0.7	M40 x 292P	.228	.292	.213	.426
10-24	1024 x 328P	M5.0 x 0.8	M50 x 328P	.259	.328	.244	.488
10-32	1032 x 328P			.259	.328	.244	.488
1/4-20	2520 x 364P	M6.0 x 1.0	M60 x 364P	.322	.364	.307	.614
1/4-28	2528 x 364P			.322	.364	.307	.614
5/16-18	3118 x 364P	M8.0 x 1.25	M80 x 364P	.383	.364	.368	.736
5/16-24	3124 x 364P			.383	.364	.368	.736

Recommended Hole Size - See chart for installation hole size. Additional information can be found on page 5, Design Guidelines.

HP Series Inserts

INCH		METRIC		A	B	L	Hole H	Min. Boss
Thread Size	Part Number	Thread Size	Part Number	±.004	±.004	±.004	+0.003 - .000	
2-56	H256 x 157P	M2.0 x 0.4	HM20 x 157P	.189	.024	.157	.121	.242
4-40	H440 x 208P	M3.0 x 0.5	HM30 x 208P	.220	.024	.208	.150	.300
6-32	H632 x 247P	M3.5 x 0.6	HM35 x 247P	.250	.029	.247	.182	.364
8-32	H832 x 292P	M4.0 x 0.7	HM40 x 292P	.283	.032	.292	.213	.426
10-24	H1024 x 207P	M5.0 x 0.8	HM50 x 207P	.313	.043	.207	.244	.488
	H1024 x 328P		HM50 x 328P	.313	.040	.328	.244	.488
10-32	H1032 x 207P			.313	.043	.207	.244	.488
	H1032 x 328P			.313	.040	.328	.244	.488
1/4-20	H2520 x 364P	M6.0 x 1.0	HM60 x 364P	.374	.050	.364	.307	.614
1/4-28	H2528 x 364P			.374	.050	.364	.307	.614
5/16-18	H3118 x 364P	M8.0 x 1.25	HM80 x 364P	.433	.050	.364	.368	.736
5/16-24	H3124 x 364P			.433	.050	.364	.368	.736

E & HE Series Expansion Inserts

E & HE Series Expansion inserts are designed to provide strong reusable threads in thermoset and other hard plastics. Inserts are pressed into the plastic and expand when the assembly screw is tightened. The sharp diamond knurling provides resistance to tensile and torque loads. The mating screw should be designed for full thread engagement. This will allow the insert to fully expand. For best results, the boss diameters should be approximately 2-1/2 times the recommended hole size. In “throughhole” applications, the HE Series flange adds greater strength for tensile pull loads.

Recommended Hole Size - See chart for installation hole size.
Additional information can be found on page 5, Design Guidelines.



E Series



HE Series

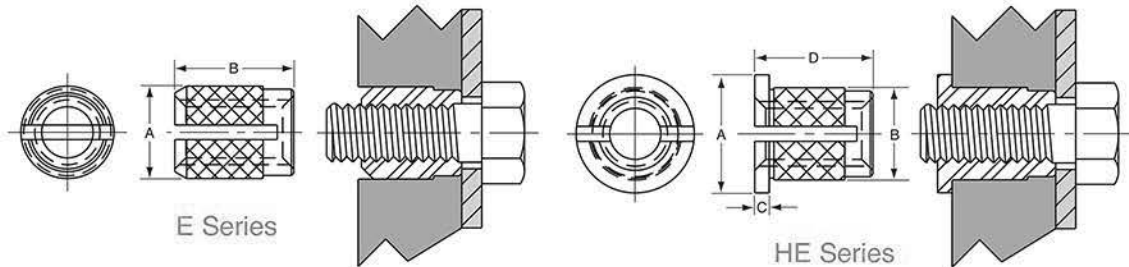

E Series Inserts

INCH		METRIC		A ±.005	B ±.005	Hole Size +.003 –.000
Thread Size	Part Number	Thread Size	Part Number			
2-56	256 x 157E	M2.0 x 0.4	M20 x 157E	.136	.157	.126
4-40	440 x 188E	M3.0 x 0.5	M30 x 188E	.165	.189	.157
6-32	632 x 250E	M3.5 x 0.6	M35 x 250E	.197	.252	.185
8-32	832 x 312E	M4.0 x 0.7	M40 x 312E	.230	.315	.217
10-24	1024 x 375E	M5.0 x 0.8	M50 x 375E	.260	.374	.248
10-32	1032 x 375E			.260	.374	.248
1/4-20	2520 x 500E	M6.0 x 1.0	M60 x 500E	.327	.500	.311
5/16-18	3118 x 500E	M8.0 x 1.25	M80 x 500E	.390	.500	.374

HE Series Inserts

INCH		METRIC		A ±.005	B ±.005	C ±.005	D ±.005	Hole Size +.003 –.000
Thread Size	Part Number	Thread Size	Part Number					
2-56	H256 x 157E	M2.0 x 0.4	HM20 x 157E	.189	.136	.024	.157	.126
4-40	H440 x 188E	M3.0 x 0.5	HM30 x 188E	.220	.165	.024	.189	.157
6-32	H632 x 250E	M3.5 x 0.6	HM35 x 250E	.252	.197	.031	.252	.185
8-32	H832 x 312E	M4.0 x 0.7	HM40 x 312E	.283	.230	.031	.315	.217
10-24	H1024 x 375E	M5.0 x 0.8	HM50 x 375E	.315	.260	.039	.374	.248
10-32	H1032 x 375E			.315	.260	.039	.374	.248
1/4-20	H2520 x 500E	M6.0 x 1.0	HM60 x 500E	.374	.327	.051	.500	.311
5/16-18	H3118 x 500E	M8.0 x 1.25	HM80 x 500E	.433	.390	.051	.500	.374

SH Series Threaded Studs

The body of this threaded stud is specifically modeled after our H Series Insert. Its key feature is the tapered design, which allows for easy insertion into tapered molded or drilled holes. They may be installed using the thermal or ultrasonic method or can be molded in place.



SH Series

Recommended Hole Size - See chart for installation hole size.
Additional information can be found on page 5, Design Guidelines.

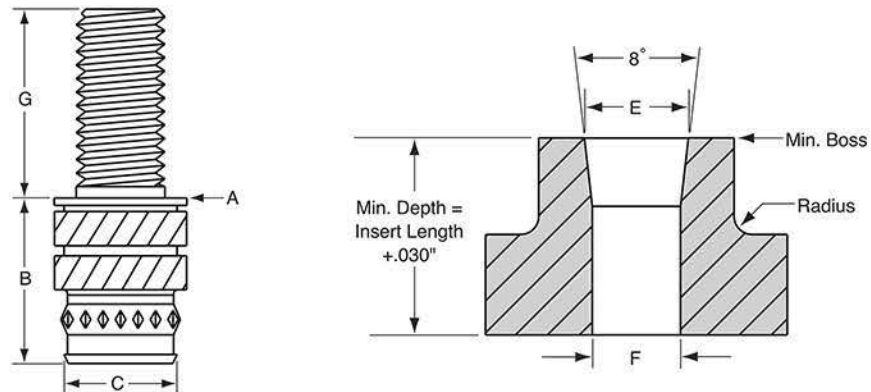

INCH		METRIC		A ±.004	B ±.004	C ±.004	Hole E +.002 –.000	Hole F +.002 –.000	G ±.010	Min. Boss
Thread Size	Part Number	Thread Size	Part Number							
2-56	S256 x	M2.0 x 0.4	SM20 x	.141	.188	.112	.123	.107	S P E C I F Y *	.246
4-40	S440 x	M2.5 x 0.45	SM25 x	.172	.219	.146	.159	.141		.318
6-32	S632 x	M3.0 x 0.5	SM30 x	.219	.250	.190	.206	.185		.412
		M3.5 x 0.6	SM35 x	.219	.250	.190	.206	.185		.412
8-32	S832 x	M4.0 x 0.7	SM40 x	.250	.312	.213	.234	.208		.468
10-24	S1024 x	M5.0 x 0.8	SM50 x	.297	.375	.251	.277	.246		.554
10-32	S1032 x			.297	.375	.251	.277	.246		.554
1/4-20	S2520 x	M6.0 x 1.0	SM60 x	.375	.500	.332	.363	.321		.726
1/4-28	S2528 x			.375	.500	.332	.363	.321		.726
5/16-18	S3118 x	M8.0 x 1.25	SM80 x	.469	.562	.406	.448	.401		.896
5/16-24	S3124 x			.469	.562	.406	.448	.401		.896
3/8-16	S3816 x	M10 x 1.5	SM100 x	.563	.625	.493	.540	.488		1.080
3/8-24	S3824 x			.563	.625	.493	.540	.488	1.080	

* When ordering, customer needs to specify the "G" dimension to form the part number.

Example: 8-32 with a thread length 1/2" (.500)" = S832 x S00C

Part numbers for Stainless Steel Inserts are the same as listed in the chart, but ending with -SS.

SC Series Threaded Studs



SC Series

The body of this threaded stud is modeled after our C Series Insert. Its key feature is the opposing diagonal knurls, which will provide exceptional rotational and tensile resistance. The SC Series is designed for straight molded or drilled holes. They may be installed using the thermal or ultrasonic method or can be molded in place.

Recommended Hole Size - See chart for installation hole size.
Additional information can be found on page 5, Design Guidelines.

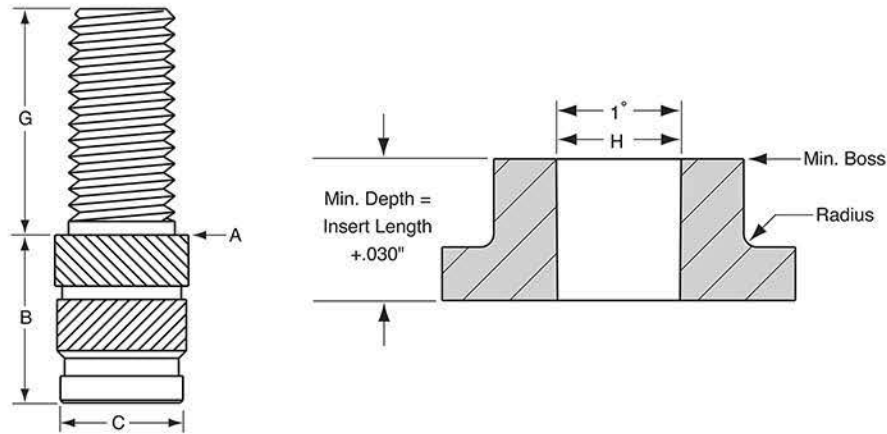

INCH		METRIC		A	B	C	G	Hole H	Min. Boss
Thread Size	Part Number	Thread Size	Part Number	±.004	±.004	±.004	±.010	+ .003 - .000	
2-56	S256 x	M2.0 x 0.4	SM20 x	.143	.157	.123	S P E C I F Y *	.126	.252
4-40	S440 x	M2.5 x 0.45	SM25 x	.186	.226	.154		.157	.314
		M3.0 x 0.5	SM30 x	.186	.226	.154		.157	.314
6-32	S632 x	M3.5 x 0.6	SM35 x	.218	.281	.185		.188	.376
8-32	S832 x	M4.0 x 0.7	SM40 x	.249	.321	.218		.221	.442
10-24	S1024 x	M5.0 x 0.8	SM50 x	.280	.375	.249		.252	.504
10-32	S1032 x			.280	.375	.249		.252	.504
1/4-20	S2520 x	M6.0 x 1.0	SM60 x	.342	.500	.312		.315	.630
1/4-28	S2528 x			.342	.500	.312		.315	.630
5/16-18	S3118 x	M8.0 x 1.25	SM80 x	.406	.500	.374		.377	.754
5/16-24	S3124 x			.406	.500	.374		.377	.754
3/8-16	S3816 x	M10.0 x 1.5	SM100 x	.498	.500	.465		.468	.936
3/8-24	S3824 x			.498	.500	.465		.468	.936

* When ordering, customer needs to specify the "G" dimension to form the part number.

Example: 8-32 with a thread length 1/2" (.500)' = S832 x S00C

Part numbers for Stainless Steel Inserts are the same as listed in the chart, but ending with -SS.



MB Series

MB Series Mold-in Blind Inserts*

This threaded insert is designed to be molded into the plastic component during the molding cycle. Typically, the insert is placed on a core pin in the mold during the molding cycle. The insert is designed with aggressive knurling and undercuts to resist rotational and tensile pull loads. The part has a closed bottom (blind thread) to eliminate plastic flow into the threads. Although our catalog insert is brass, this product can also be manufactured in stainless steel, steel and aluminum. See our website for stock sizes or contact our Engineering Department.

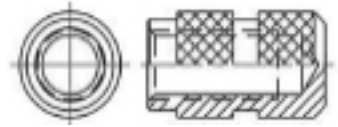

* The manufacturing process may leave a small cut-off nib on the closed end. Refer to our website for common sizes.



RM Series

RM Series Rotational Mold-in Blind Inserts*

Designed primarily for rotational molding, the hex and undercut features provide high resistance to torque and tensile pull loads. The part has a closed bottom (blind thread) to eliminate plastic flow into the threads. Various sizes and lengths can be manufactured to your specifications. See our website for stock sizes or contact our Engineering Department.

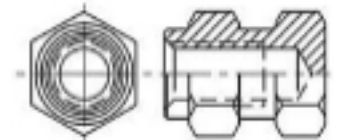

* The manufacturing process may leave a small cut-off nib on the closed end. Currently available on custom basis only.



KS Series

KS Series Knurled Spacers, Threaded

Knurled spacers are popular in a number of different applications. They are commonly used for spacers in stacking components, including printed circuit boards. They can also be molded into a plastic part that requires a permanent metal thread. See our website for stock sizes or contact our Engineering Department.

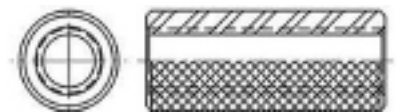

CL Series

CL Series Compression Limiters

Compression limiters are commonly used in applications where a compressive load is applied to a plastic assembly. The compression limiter strengthens the plastic and resists the load that is applied. The integrity of the plastic, therefore, is not compromised. Generally speaking, compression limiters are made to meet your individual specifications. Various lengths and sizes can be manufactured to accommodate inch and metric bolts. Call our Engineering Department to discuss your requirements.

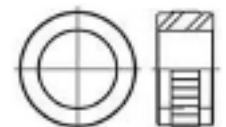

Specials & Custom Designed Parts



Special Inserts



Precision Machined Products

Our business philosophy encourages success through the teamwork concept. Included in this philosophy is the relationship created between RAF and you, the customer. Design Engineering starts the process of building this partnership.

We take pride in our ability to design custom inserts specifically for your application.

During our Design Input Process, our Engineering Department will utilize their extensive manufacturing and machining knowledge to design an insert that incorporates the specific parameters that you provide us. The end result is a design that will meet or exceed your specific requirements and be cost effective to produce. Additionally, we can recommend alternative designs in an attempt to provide you with the total lowest cost possible for your application. Our Engineering Department will provide a CAD specification for your review and subsequent approval.

Our Engineering Department teams up with the Sales Department to provide you with a prompt quotation for your requirements. Our short delivery times and low minimum order quantity lead the insert industry.

We understand there are times when a standard insert will not meet the specific requirements of your application. The next time your project calls for a special insert, contact our Engineering Department. We will be more than happy to work with you to provide an effective design for your application.



PRIMARY EQUIPMENT:
**28 DAVENPORT 5-SPINDLE
AUTOMATIC BAR MACHINES**

The Davenport 5-Spindle Automatic Bar Machine is designed to offer a cost-effective means for high-volume production of close tolerance parts turned from a bar. Throughout the industry, the Davenport is widely considered to be the fastest, most versatile multiple-spindle automatic bar machine ever built. These machines have the capability of performing multiple machining operations within the cycle time of the machine. This capability eliminates the need for costly secondary operations. The machining capabilities and features of the Davenport include:

- Thread Rolling
- Thread Cutting
- Slotting
- Knurling
- Conventional Tapping
- Bent Shank Tapping
- Milling
- Reaming
- Cross Drilling
- Cross Tapping
- Broaching
- Back Drilling
- Countersinking
- Counterboring
- Deburring

Bar Stock Capacity*

- Round bar starting at .0937" [2.38mm] up to .8125" [20.64mm]
- Hex bar starting at .125" [3.18mm] up to .625" [15.87mm]
- Square bar starting at .125" [3.18mm] up to .5625" [13.89mm]

Material Capability*

Free machining grades of Aluminum, Brass, Bronze, Copper, Carbon Steel and Stainless Steel. The most common grades are Aluminum 2011 T3, Brass Alloy 360, Steel C1215 & C12L 14, Stainless Steel Alloys 203, 303 & 416.

Part Length Capability*

Starting at approximately .0625" [1.59mm] up to 2.500" [63.50mm]

Tolerance Capability*

Lengths as close as $\pm .002$ " [0.05mm]

Diameters as close as $\pm .001$ " [0.025mm]

* The information and data contained in the stated capacities and capabilities are for general information purposes only and may be based on "best case scenarios." Application specific criteria such as component design, material and finish requirements will dictate the true or actual capabilities.

Quality, Cleaning & Laser Sorting



Quality

All parts produced at RAF Electronic Hardware have been identified with critical-to-function features. These features are prominently noted on all part prints. Operators are trained in the use of all software, hardware and measuring Instruments. The production floor data collection system is networked, in real time, to the Quality Department to allow the Quality staff to monitor and control all activity.

Parts Cleaning

A state-of-the-art, environmentally friendly, aqueous parts washing system cleans and dries all components manufactured at RAF. The computer-controlled system employs agitation, rotation, submersion, jet-spray and ultrasonic cleaning methods. Components are housed in stainless steel mesh baskets specifically designed to allow the parts to tumble during the cycle time. The system and the baskets allow for an extraordinary flow of fluids to flush the parts clean of cutting fluids, metal turnings and debris. A seven-chamber dryer assures that the parts are free of any and all moisture.

Laser Sorting

Where specified, high-volume automotive components and high-volume automated assembly applications are laser sorted to ensure 100% compliance on critical-to-function features. Common attributes include overall length, presence of thread or through-hole obstructions. Parts are bowl fed through a series of gates, traps and rails. The parts become oriented before they pass a series of laser beams, which identify the part as conforming or non-conforming. An electronic and air-activated diverter segregates any non-conforming product. An automatic packaging system is attached where the parts are laser counted as they enter the shipping container.





About MW Components

MW Components is focused on accelerating the entire process of delivering custom, stock, and standard parts to virtually any volume and against demanding deadlines. We work to highly complex tolerances. We help simplify the management of any number of different components. And we take a no-compromise approach to quality. With MW Components, you can be sure you'll get the right part to the right specification when and where you need it.

MW Components. Whatever it takes.

[MWComponents.com](https://www.MWComponents.com)