

# SPEBlox-Long

Tini 10 Mbps over 1.6km

MPN: BB-SPL-A-1

## Preliminary Datasheet

February 2022  
Board revision A

# Contents

<b>Contents</b>	<b>2</b>
<b>1 General Information</b>	<b>3</b>
1.1 Functionality and Features of SPEBlox-Long	3
1.1.1 Features	3
1.1.2 General Information	4
1.1.3 General Operating Instructions	4
1.2 Safety Information	5
1.3 Block Diagram	5
1.4 Included Equipment	6
1.5 RoHS Certification of Compliance	6
<b>2 Hardware Interfaces</b>	<b>7</b>
2.1 Board Map	7
2.2 Connectors and Pinouts	8
2.2.1 Voltage Input	8
2.2.2 Ethernet Port	9
2.2.3 SPE Port	10
2.2.4 SWD Programming Header	10
2.3 Other Interfaces	11
2.3.1 LEDs	11
<b>3 Software Interfaces</b>	<b>12</b>
3.1 UART	12
<b>4 Device Configuration</b>	<b>12</b>
4.1 Unmanaged Converter	12
<b>5 Device Characteristics</b>	<b>13</b>
5.1 Operating Conditions	13
5.1.1 Absolute Maximum Ratings	13
<b>6 Datasheet Changelog</b>	<b>13</b>
<b>7 Contact</b>	<b>13</b>

# 1 General Information

## 1.1 Functionality and Features of SPEBlox-Long

SPEBlox-Long is a communication device that provides 10Mbps at extremely long cable runs upto 1600m (1.6km) over simple twisted pair copper cable.

This technology is based around the 10BASE-T1L specification, and this board aims to provide a cheaper and simpler way of achieving reasonably low bandwidth communication over very long cable runs.

SPEBlox-Long is 31mm x 31mm and provides a standard 10BASE-T ethernet connection on Picoblade header. The 10BASE-T1L (single pair ethernet) connection is placed onto a screw terminal for full flexibility of cable types. The board is powered by any voltage from 5 to 60V

### 1.1.1 Features

- 1 x 10Mbps (10BASE-T) ethernet port
- 1 x 10Mbps (10BASE-T1L) single pair ethernet
- Input voltage range from 5 to 60V
- Reverse protected voltage input
- Transient protected voltage input
- -40°C to 85°C Operation Range
- 31mm x 31mm board size
- Molex PicoBlade connectors for power and 10BASE-T port
- Screw terminal block for SPE port
- Automatic MDI-X crossover
- Unmanaged (out-the-box) functionality
- Embedded MCU to support customized firmware upload for managed switch functions
- Port Activity Indicators

### 1.1.2 General Information

<b>Voltage Input</b>	5V to 60V DC (65V absolute max)
<b>Voltage Output</b>	None
<b>Supported Protocols</b>	10BASE-T, 10BASE-T1L
<b>Number of ports</b>	1 x 10BASE-T, 1 x 10BASE-T1
<b>Power Consumption</b>	0.5W at full data rate
<b>Weight</b>	10 grams
<b>Size</b>	31 mm x 31 mm x 17mm
<b>Operating Temperature</b>	-40°C to +85°C
<b>Storage Temperature</b>	-55°C to +125°C

*Table 1: General Information*

### 1.1.3 General Operating Instructions

SPEBlox-Long is designed for use in commercial and industrial environments, operating from a nominal supply voltage of 24V, but with the ability to operate from as low as 5V and as high as 60V.

SPEBlox-Long can be operated immediately by following the steps below.

- 1) Connect two SPEBlox-Long together through the SPE port, using a 2-wire twisted pair cable
- 2) Connect external devices to the ethernet ports using RJ45 to Picoblade cables.
- 3) Apply a voltage between 5V to 60V to the voltage input terminals.

SPEBlox-Long will automatically begin auto-negotiation with connected devices and begin receiving and forwarding packets to/from all connected devices.

## 1.2 Safety Information

- This device can operate on voltages near and above 60V. Please read this manual before operating.
- This device is provided “as is”. In-application testing prior to integration is recommended.
- This device is provided as an electronic circuit board, and requires integration into chassis for full ingress protection.
- Do not use this product in wet environments without integrating into a chassis.
- Do not operate this product beyond the rated temperature and voltages.

## 1.3 Block Diagram

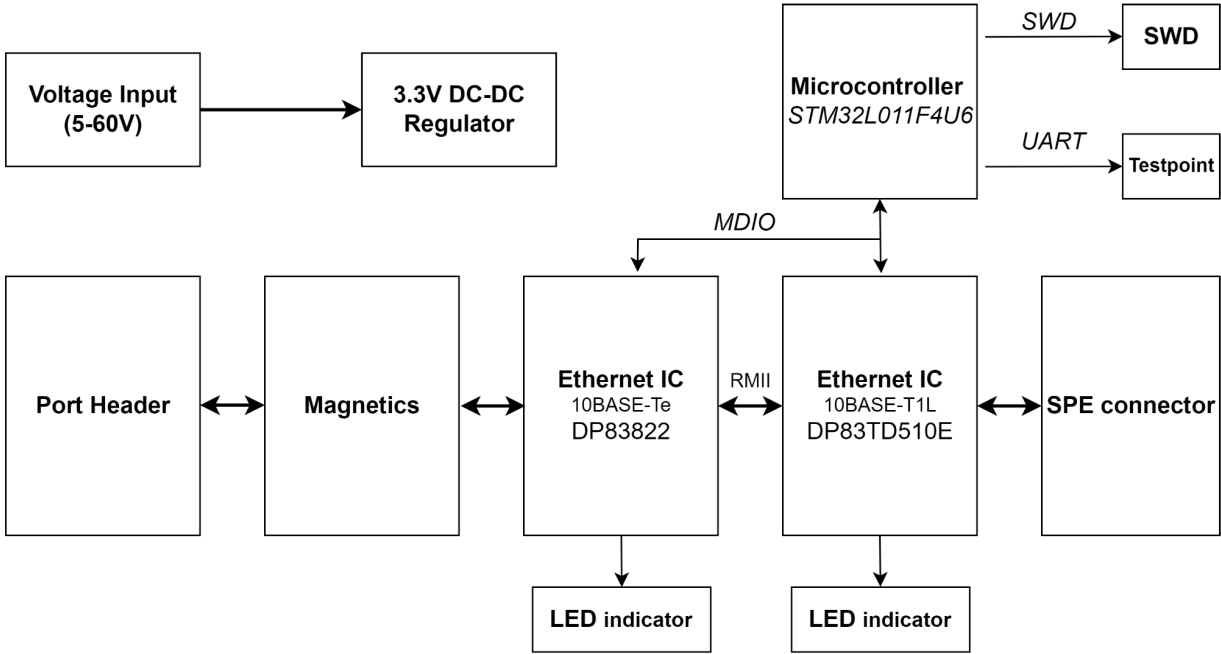

Figure 1: SPEBlox-Long Block Diagram

## 1.4 Included Equipment

The product includes the following:

1 x SPEBlox-Long

1 x Molex PicoBlade to RJ45 4-way Shielded Twisted Pair cables (300mm)

1 x Molex PicoBlade Power Cable to bare, tinned leads (300mm)

## 1.5 RoHS Certification of Compliance

SPEBlox-Long complies with the RoHS (Restriction of Hazardous Substances Directive) Certificate of Compliance.

## 2 Hardware Interfaces

### 2.1 Board Map

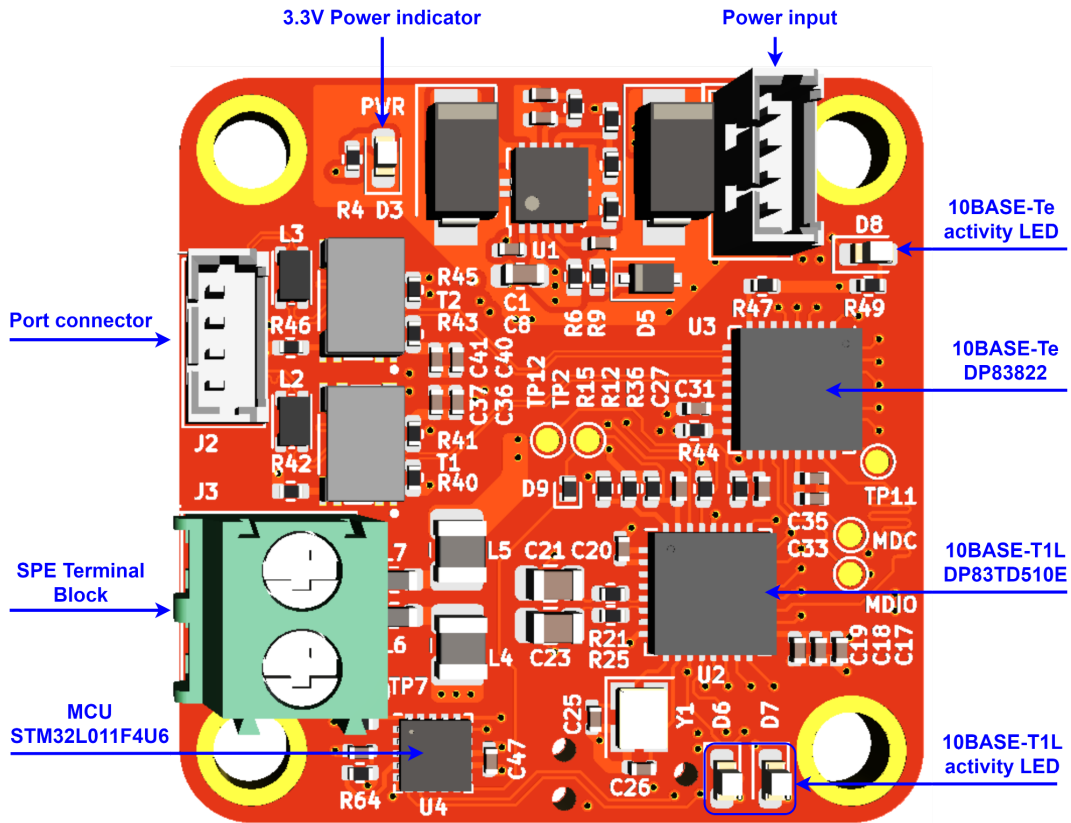

Figure 2: SPEBlox-Long Board Map (front)

## 2.2 Connectors and Pinouts

### 2.2.1 Voltage Input

The right connector is the voltage input terminal. A four pin connector is used to allow the input voltage to be easily daisy chained between boards (two wires per power rail).

The voltage input has the following features:

- Voltage input can range from 5 to 60V
- Maximum allowable voltage of 65V
- Transient voltage protection above 66.3V
- Reverse polarity protection

The pinout of the voltage input connector is shown in figure 3 below. Note that this pinout is identical to the pinout used on SwitchBlox.

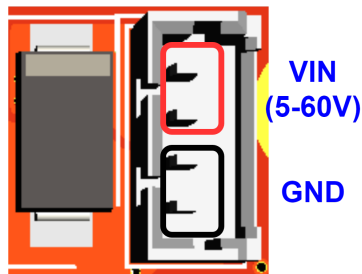

Figure 3: Voltage input header pinout

Connector part numbers

Connector on board	Mating header	Crimp used	Wire used
<a href="#">530470410</a>	<a href="#">0510210400</a>	<a href="#">500798000</a>	UL1061, 28AWG

Table 2: Voltage input connector pinout and part numbers

Cable pinout

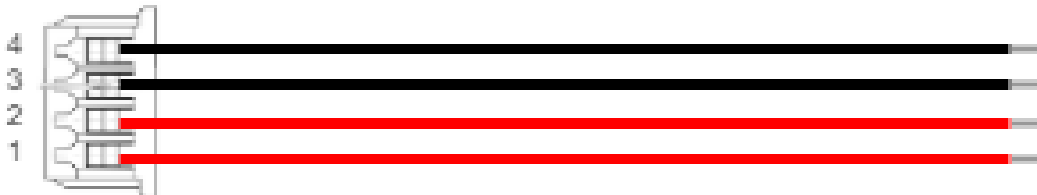

Figure 4: Voltage input cable pinout (red = V+, black = GND)



## 2.2.2 Ethernet Port

There is an ethernet connector on SPEBlox-Long. The connector has four pins corresponding to the four signals required for 10BASE-T<sub>e</sub> which are R-, R+, T- and T+.

Figure 5 below shows the pinout of the signals. Note that this pinout is unified across all our products.

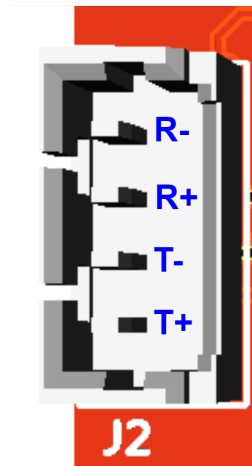

Figure 5: Ethernet port pinout

Connector on board	Mating header	Crimp used	Wire used
<a href="#">530470410</a>	<a href="#">0510210400</a>	<a href="#">500798000</a>	UL1061, 28AWG

Table 3: Ethernet connector pinout and part numbers

Cable pinout

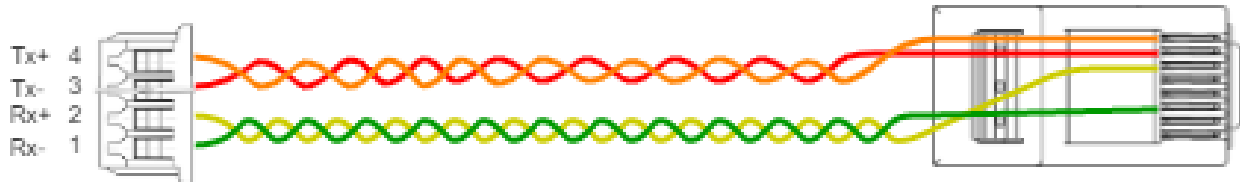

Figure 6: Ethernet cable pinout

### 2.2.3 SPE Port

There is a SPE terminal block on SPEBlox-Long (MPN: [1984617](#) )

Figure 7 below shows the pinout of the signals

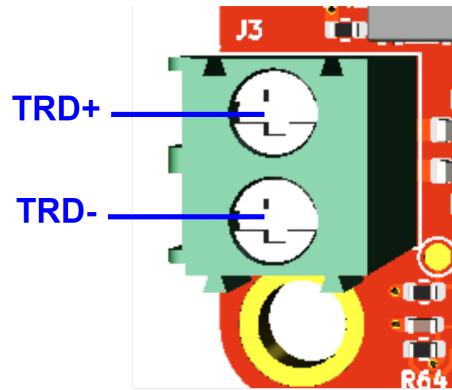

Figure 7: SPE Terminal Block pinout

### 2.2.4 SWD Programming Header

A programming header on the back of the board allows the STM32L011F4U6 on SPEBlox-Long to be programmed over SWD.

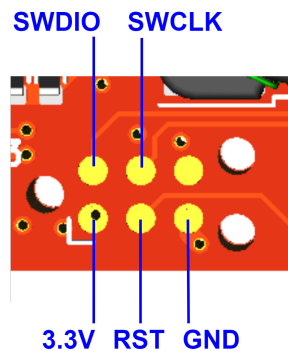

Figure 8: SWD programming header pinout

This header allows access to the SWD port on the onboard STM32 microcontroller, and requires the use of a 6-pin needle adapter such as the [J-Link 6-pin needle adapter](#) along with an in-circuit programmer such as the [J-Link](#).

## 2.3 Other Interfaces

### 2.3.1 LEDs

There are four LEDs on SPEBlox-Long in total. None of the LED signals can be taken off board.

The 3.3V Power Indicator LED (**Green**) indicates that voltage is present on the 3.3V line. It should be solid green in normal operation.

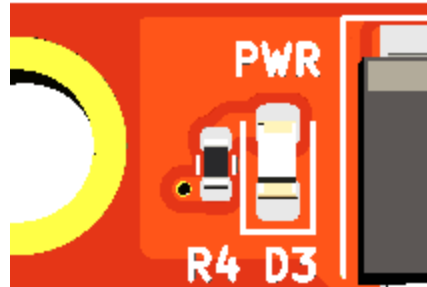

Figure 9: Power Indicator LED

SPE LED D6 (**Green**) indicates link status and blinks for TX/RX Activity for the 10BASE-T1L port.

SPE LED D7 solid on **Green** indicates Long Reach mode 10BASE-T1L port.

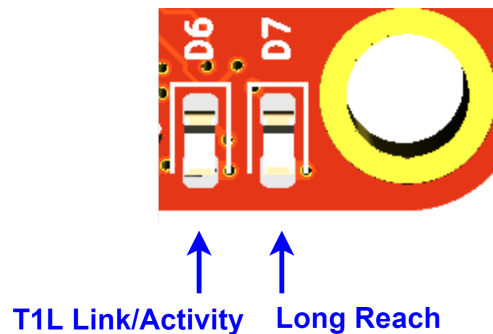

Figure 10: SPE Indicator LED

LED D8 (**Green**) indicates port Link/Activity on the 10BASE-T port. The LED is ON when the link is good. The LED blinks when the transmitter or receiver is active.



Figure 11: Port Indicator LEDs

## 3 Software Interfaces

### 3.1 UART

Pins PA0 (UART2\_RX) and PA9 (UART2\_TX) on the onboard STM32L011F4U6 are exposed on test points. The factory default firmware does not support configuration over UART.



*Figure 12: UART Testpoint*

## 4 Device Configuration

### 4.1 Unmanaged Converter

To use SPEBlox-Long in an unmanaged application requires no configuration, simply connect a voltage to the voltage input, connect two SPEBlox-Long devices via SPE port and connect downstream devices. More advanced configuration of the transceiver settings on SPEBlox-Long is possible by modifying the firmware running on the STM32 onboard. Please contact us for support on this.

## 5 Device Characteristics

### 5.1 Operating Conditions

#### 5.1.1 Absolute Maximum Ratings

Operating in these ranges will reduce the lifetime of the device.

<b>Voltage Input Maximum</b>	65V
<b>Storage Temperature</b>	-40°C +125°C
<b>Operating Temperature</b>	-40°C +85°C

## 6 Datasheet Changelog

<b>Date</b>	<b>Datasheet Version</b>	<b>Author</b>	<b>Notes</b>
20/02/2022	A_A	Josh Elijah	Preliminary release

## 7 Contact

If you have any questions regarding this product, please contact us:

info@botblox.io  
4 Pavilion Court 600 Pavilion Drive,  
Northampton Business Park,  
Northampton,  
England  
NN4 7SL