



Atx Led Consultants Inc  
1108 Lavaca St – STE 110-489  
Austin Tx, 78701  
512 377 6052

<http://atx-led.com>

[Click for the FAQ on this product](#)

## ATX LED Hub

DA bus master  
System Hub

SML case format

Hue emulation,  
home automation,  
white and tunable white

SML or  
DIN rail mounting

Second DA bus and DMX512 output optional

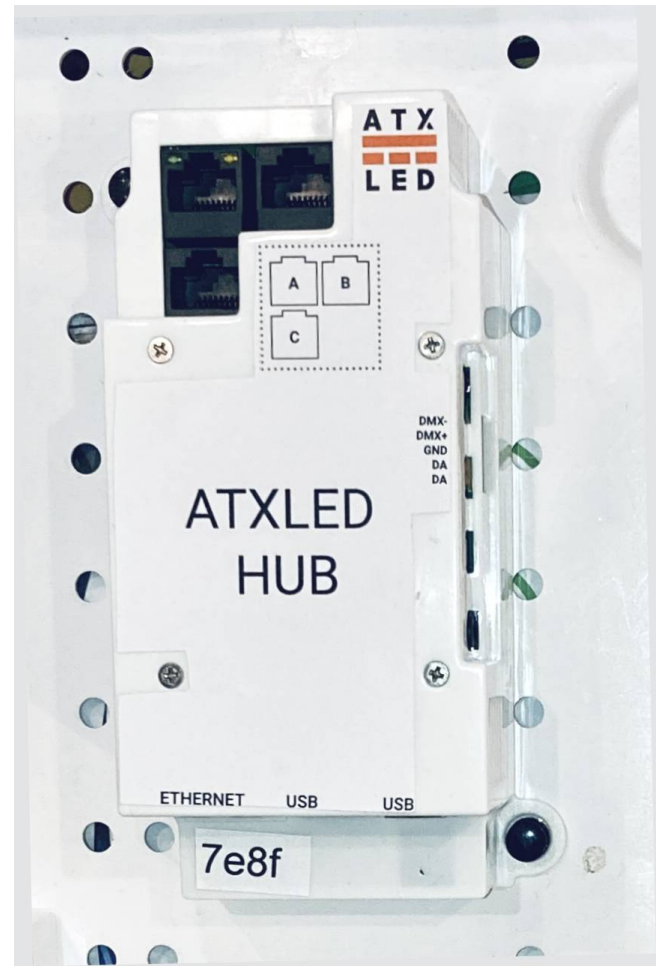

### Product Description - ATX LED Hub

This hub manages a DALI lighting system. It can operate stand alone or can connect a DALI bus with the Cloud. It assigns useful names to the physical addresses of each driver, and allows all DALI features of the drivers to be configured by any user. If cloud enabled, it allows access to Alexa, Google and Siri for home automation. The main user friendly features of this device are:

- Assign persistent friendly names to each DALI switch or DALI driver
- Synchronize names and status with Alexa / Google Home
- Create/Edit/View Scenes and Groups
- Turn on/off any device, set brightness, fade rate, minimum/maximum levels
- Create schedules and macros, support API calls
- Connect with DMX devices via AL-DALI-DMX
- Control tunable white with DT8
- Set special modes like Fan timers, 3-Way switching
- Detect power outages and manage as needed
- Powered by Passive PoE cable

### Local Management

This device connects by Ethernet or WiFi to your network. Then, you can connect to it to access the management pages. Examples are shown below: Use any web browser.

## Hue Emulation

After assigning names to wall switch or fixture, the device will appear to the Hue App as a Hue Bridge with the names of the lights that you created.

## Schedules and timers and macros

Use the built in scheduling or use Cloud apps for advanced controls. Run Python scripts as you like.

# Technical Features

- Passive PoE Power from RJ45 44 to 56 volts, 300 mA required – can use A, B or C inputs
- Primary DALI bus for 64 addresses, 16 groups, 16 scenes, configurable DALI power source, non isolated
- Secondary (optional) DALI bus for 64 more addresses, 16 groups, 16 scenes, Isolated
- DALI bus power source. Software selectable as Off, 80 mA or 200 mA. 16 volt open circuit, 15v fully loaded.
- Monitoring of the 48v inputs. The System reports the status of power on pins 4 and 5 of the RJ45  
A – 50 mV precision individually on pins 4 and 5  
B and C – On/Off status of pins 3, 4 and 5
- Programmable Fan with internal set point
- DMX512 input/output on the green connector (optional)

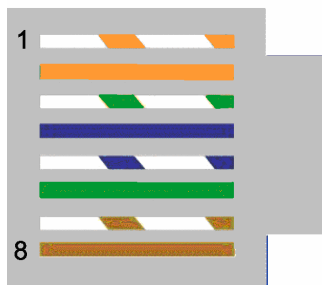
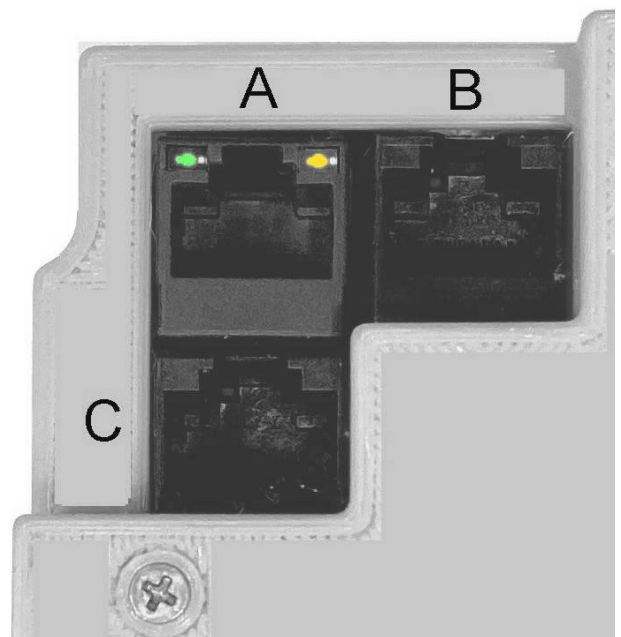

Pin	A	B	C
1	DALI +	DALI +	DALI +
2	DALI – (gnd)	DALI – (gnd)	DALI – (gnd)
3	NC	NC	+ Voltage C1
4	+ Voltage A1	+ Voltage B1	+ Voltage C2
5	+ Voltage A2	+ Voltage B2	+ Voltage C3
6	Ground	Ground	Ground
7	Ground	Ground	Ground
8	Ground	Ground	Ground

# Power to the ATX LED Hub, Monitoring and Failover

Apply power using the Rj45 connector cable – this device uses passive PoE. Power sources are the AL-DALI-8-sml, AL-DF10, AL-DALI-6-sbk. The device operates from 24 to 56 volts and 12 watts max (including the Pi). The 7 power inputs on the Rj45 are designed for redundancy – the board will operate with any connected, and will signal to the Pi which are operational.

Inputs B1, B2, C1, C2, C3 are 1 mA loads. The level is measured as 1 if > 20 volts and 0 if less than 9 volts

Power Input	Method	Accuracy	Raspberry Pi port
A1	Serial Port	50 mV	NA
A2	Serial Port	50 mV	NA
B1	GPIO Port	On/Off	GPIO6 / pin 31
B2	GPIO Port	On/Off	GPIO26 / pin 37
C1	GPIO Port	On/Off	GPIO5 / pin 29
C2	GPIO Port	On/Off	GPIO22 / pin15
C3	GPIO Port	On/Off	GPIO27 / pin 13

## Powered DALI bus #1 connection

The RJ45 connector also has DALI data. You can use an external DALI power supply, or the internal one. Observe the + and – polarity if more than one DALI power supply is active on the same bus.

## DALI bus power – automatic maximum current

The ATX LED HUB has an on-board DALI power supply with 0, 65 or 200 mA. If you elect to connect multiple DALI power supplies in parallel – then please observe the polarity. The Hub measures the DALI line at power up, and adjusts the on-board supply to insure that at least 65 mA is available, and not more than 260 mA. This feature can be managed in software.

## Isolated DALI bus #2 connection

The device has a 2<sup>nd</sup> DALI port. This is isolated and polarity insensitive. Contact the factory for activation of this 2<sup>nd</sup> DALI port

## DMX512 port

The Device has a RS485 port that can be used for DMX512 operation. Contact the factory for activation of this DMX port

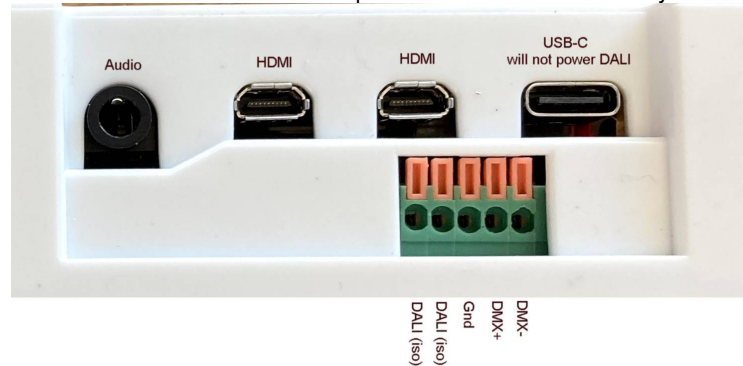

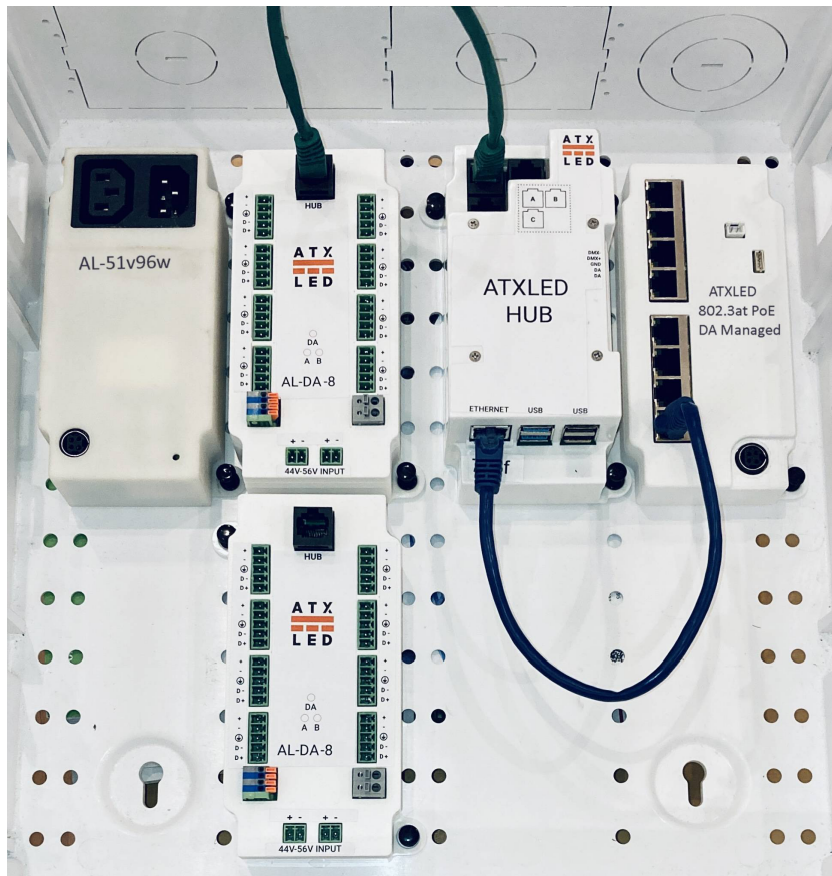

# Raspberry Pi

The ATX LED Hub uses a Raspberry Pi Linux computer. We provide the power 5 volts 10 watts to the Pi.

## First Time use – WiFi and Internet

Connect the Hub to the power source, Connect the Ethernet port to your home network, or use the WiFi built-in. See <https://atxled.wiki.zoho.com/public/Changing-the-SSID.html>

Once connected: go to the following web site from the same WiFi or LAN network: <http://me.atxled.com> – this will redirect you to the ZWD application that runs on the Hub. If you are not on the same network – you will get an error message. Visit the WiFi page and connect to your home WiFi network, or use the Ethernet port

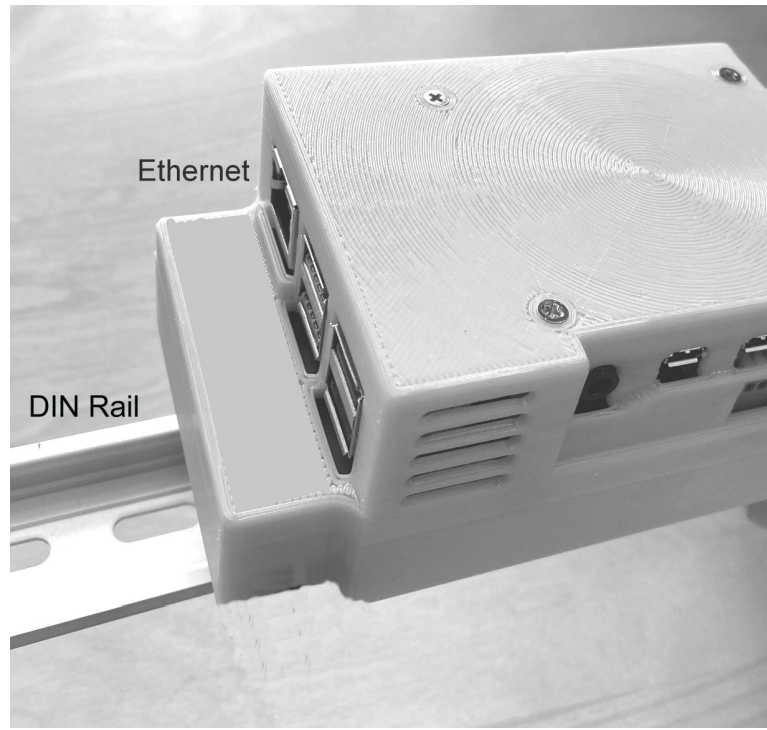

## First Time use – DALI bus provisioning

Once in the Hub – go to the **Admin** tab and click on update to assure you have the latest version. Then in the section **Provisioning** click on **Address Assignment** to find and set the addressing of the DALI devices. From the factory – DALI devices only respond to Broadcast commands. Provisioning assigns a short address to factory defaulted drivers. After a short address has been assigned, the drivers will appear in the **Devices** tab, then you can give these devices names. Two names are assigned for each device, a name for the installation, and a name you wish to use for Alexa / Google / Siri. Leave the Alexa et all name blank to hide it from cloud management.

## Connect via Hue to Alexa, Siri, Google and remote diagnostics

With Hub configured with devices and names – you can now enable Cloud management. See <https://atxled.com/Hue> for details.

For controlling your lights when not at home, our recommendation is to use the Smartthings hub from Samsung. See <https://atxled.com/SmartThings>

**For advanced users, to manage this device remotely – please create an account with the service <https://dataplicity.com>. For tech support from ATX LED – we will need you to set up Dataplicity and give us access remotely.**

# Sample Web Pages

The dashboard features a top navigation bar with the ATX-LED logo, a clock icon, a 'Show More Devices' button, the location '815 Brazos Residence', and a settings gear icon. Below this is a brightness slider. The main area contains a grid of 16 light controls, each with an 'ON' or 'OFF' button and a percentage indicator. The controls are: Kitchen 100%, Living 80%, Study 75%, Garage 100%, Master 0%, Kids 0%, Entrance 0%, DALI driver 0%, Group A 77%, Group B 0%, Scene A 10 minutes ago, and Scene B 2 hours ago.

The 'Hue Emulation' app interface is shown on a mobile device. It features a 'Hue Bridges' section with a 'Philips hue' bridge connected at 192.168.5.30. The main 'Bulbs' section lists several light fixtures: 'Desk ATX-LED', 'Kitchen ATX-LED', 'Laynew ATX-LED', 'Light 16 ATX-LED', and 'DR2F ATX-LED'. Each bulb has a corresponding color and a brightness slider. A 'Hue Bridges' sidebar on the right shows the bridge's status as 'Connected' and provides details like ID, IP address, MAC address, and SW version.

The configuration page for DALI Devices includes a sidebar with categories: DALI Devices, Other DALI, Groups, Scenes, Schedule, Triggers, DMX Groups, Hue, Admin, Support, WiFi Setup, DALI Log, Advanced, ZWave, and ZWave Logs. The main area shows settings for 'DR2G 2x6' and 'DR2G 2x4 CCT'. A 'Config' section includes fields for 'Edit name' (LDD), 'Hue name', 'Groups' (a grid of 15 buttons), 'Fade Time' (0 seconds), 'Fade Rate' (357.8 steps/second), 'Min Level', 'Max Level', 'Power On Level', and 'Fail Level'. A 'Status' section displays technical details like Channel, Short address, Model ID, UPC, Serial #, FW Version, HW Version, and Phy Min Level.

The 'Schedule' configuration page includes buttons for 'Export', 'Choose File', and 'Import'. A 'New Entry' button is at the top. The 'Scenes' section shows a 'sunrise' scene. The 'Schedule' section is expanded to show a 'sunset' scene with an 'Edit name' field, a 'When?' dropdown set to 'Sunset', an 'Offset' of 10 minutes, and 'On weekdays' checked. The 'Actions' section shows a list of lights with their current levels and 'Set' buttons: Deck (11), Garden (11), Entrance (11), and Master (11). There are also 'Bedtime' and 'Midnight' sections.

The 'Admin' configuration page shows the 'Status' section with details like 'ZPDS version: 0133-94f577d', 'Channel: 1', 'HW type: 1', 'HW version: 02', 'FW version: 08', and 'DALI power status' (mode: 88 mA (locked), voltage: 15.715V, current: 0.042A, 0.170A, 0.176A). The 'Site Name' is '1608 ADU'. The 'Provisioning' section includes buttons for 'Rescan Addresses', 'Assign Addresses', and 'Assign Addresses (quick)'. A warning message states: 'This address assignment is faster, by skipping devices that already have short at the same short address, so won't always be correct.' The 'Manual address reassignment' section has a 'WARNING: only use this if you know what you're doing!' and a 'DALI Channel' dropdown set to 1, with 'Old Address', 'New Address', and 'Re-assign Address' buttons.

The 'Groups' configuration page shows a list of groups. 'Group 0' includes 'Deck, Garden, Entrance' and 'Group 2' includes 'Living, Kitchen'. Each group has a toggle switch and a brightness slider. The 'Group 2' slider is currently set to 253.

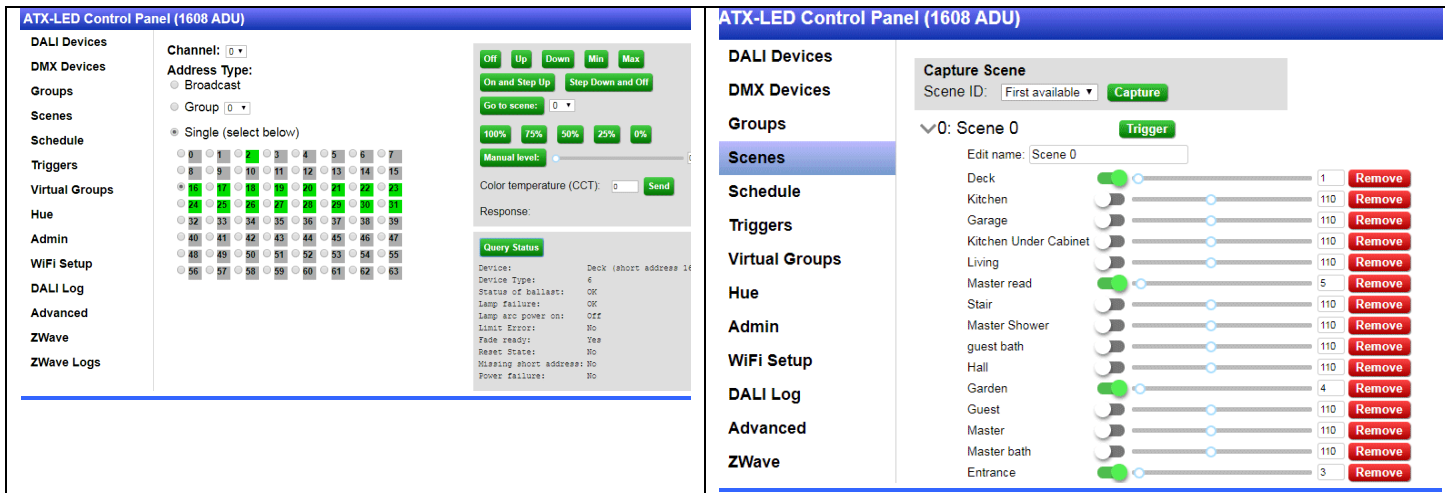

## [API for custom applications](#)

Knowledgeable users can write a python or other program to transmit and receive DALI commands using an API. See [http://atxled.com/Pi/API\\_OnOff.py](http://atxled.com/Pi/API_OnOff.py). An example of a shell command is this:

```
curl -XPOST -d '{"channel":0,"commands":["hFE00","h0AFE"]}' -H
"Content-Type: application/json" http://localhost/dali/api/send-raw
```

please see the AL-DALI-HAT data sheet for the format of these commands. One or many DALI commands can be sent with one API call. In this example, two commands are sent. FE 00 turns all lights off. 0A FE sets light at address 5 to 254. The API sends the commands and returns a response. The processing time is about 25 ms per command. The above examples will return "N,N" meaning 2 commands were sent and neither had a response. A response is formatted as a Jxx where xx is the 8 bit response. For the one channel device – the only value is 0 ( for 2, and 4 channel hats – the values are 0,1 or 0,1,2,3 respectively )

# DALI bus products from ATX LED Consultants

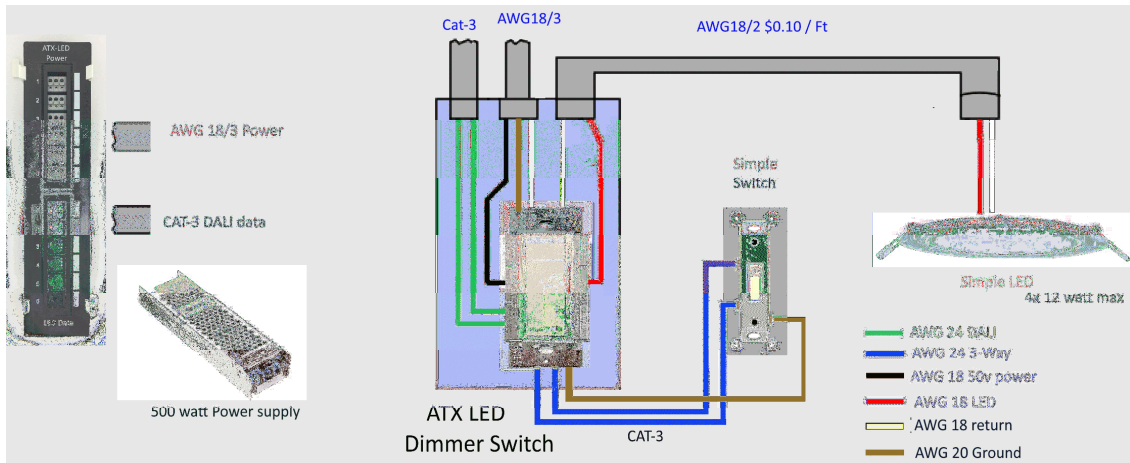

## Low Voltage house lighting product line

