

## SSIM-100

### SELF-START IMPEDANCE MATCHING POWR CONVERTER

#### 1. FEATURES

- Verified 80% of maximum circuit efficiency
- Wide range of input voltage: 2 V to 20 V
- Up to 60 mA output current
- Cold-start capability without battery
- Selectable impedance of circuit for impedance matching with piezoelectric energy harvester
- Temperature-compensated battery protection
- Over discharge protection
- Selectable output voltage: 1.8V, 2.5V, 3.3V

#### 2. APPLICATIONS

- Piezoelectric cantilevers
- Piezoelectric multilayered stacks
- Vibrational energy harvesting
- Impact force energy harvesting
- Acoustic underwater energy harvesting

#### 3. DESCRIPTION

The SSIM-100 is self-start impedance matching with ultralow quiescent current power supply designed specifically for energy harvesting. Intermittent or continuous energy input from the vibration energy harvesting device stores their associated energy in battery or supercapacitor. Notably, the self-start functionality can start operation even when a battery or a supercapacitor is fully discharged. To save power, the circuit monitors the onset of vibration or impact excitation to automatically switch between sleep and active modes.

The self-start charging circuit has a full-wave bridge rectifier for AC to DC conversion, a buck-boost converter for impedance matching, a self-start controller for power saving, and battery protection. When temperature change, the battery protection circuit compensates the floating voltage to protect the battery. A under-voltage lockout (UVLO) function is included to prevent an over discharge of the battery. SSIM-100 regulates storage device voltage for stable voltage supply with selectable voltages (1.8 V, 2.5 V, 3.3 V).

#### 4. APPERANCE

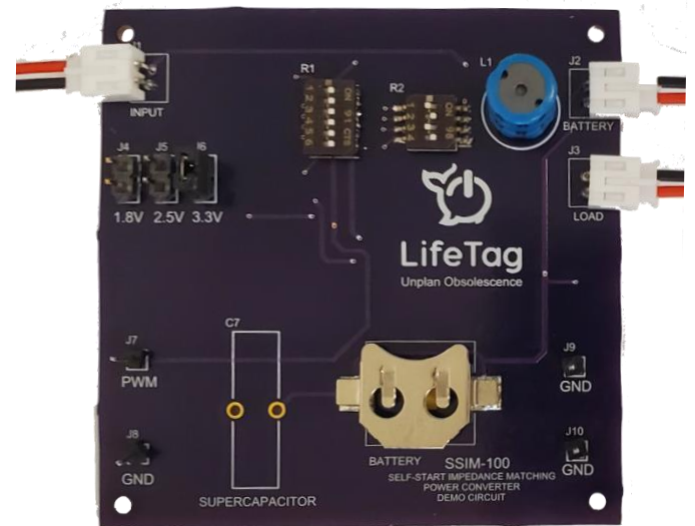

Size of board: 2.5 (W) × 2.5 (L) inches

## 5. PIN CONFIGURATION

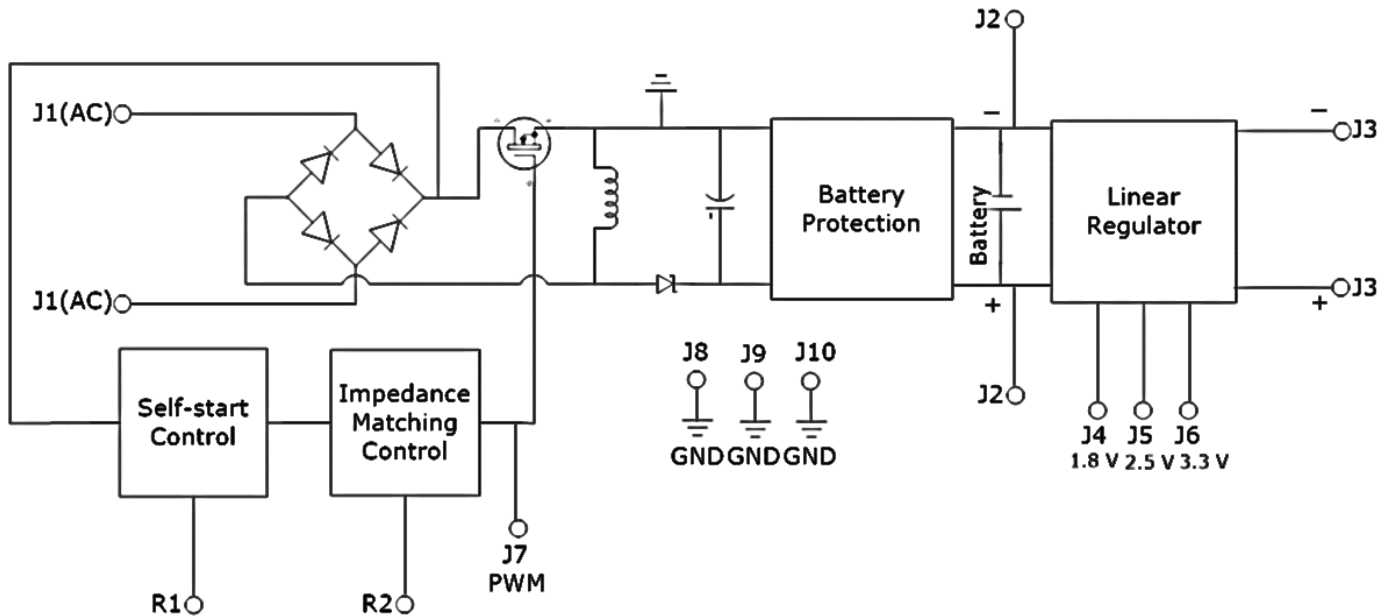

## 6. PIN FUNCTIONS

Pins	Description
J1	Input Connection for piezoelectric energy harvester
J2	Storage device output with battery protection (Red: +, Black: - )
J3	Selectable output load based on J4-J6 (1.8 V, 2.5V, or 3.3V), (Red: +, Black: - )
J4	Connect female jumper header to set output voltage $V_{out}$ to 1.8 V
J5	Connect female jumper header to set output voltage $V_{out}$ to 2.5 V
J6	Connect female jumper header to set output voltage $V_{out}$ to 3.3 V
J7	PWM output
J8-J10	Ground
R1	It determines the impedance value for matching the impedance with harvester. It can be tune based on Table 1
R2	Self-start controller. It can be tune based on Table 2
Battery	Socket for Battery connection
Supercap	Supercapacitor connection

## 7. SPECIFICATION

### 7.1 ABSOLUTE MAXIMUM RATINGS

Absolute Maximum Ratings			
<b>Input Voltage:</b>	20 V	<b>Impedance Matching Value:</b>	200 k $\Omega$
<b>Input Current:</b>	60 mA	<b>Operating Temperature Range:</b>	-40 to 105 $^{\circ}$ C
<b>Output Floating Voltage:</b>	4.2 V at T < 40 $^{\circ}$ C		

### 7.2 ELECTRICAL CHARACTERISTICS

Parameter	Min	Typ	Max	Unit
<b>Input Voltage</b>	2		20	V
<b>Input Current</b>	0		60	mA
<b>Output Current</b>	0		50	mA
<b>Output Power</b>	0		210	mW
<b>Quiescent Current</b>		1.4	2.0	$\mu$ A
<b>Impedance Matching Ranges</b>	1.4		200	k $\Omega$
<b>Switching Frequency</b>	3		6	kHz
<b>Under-lockout voltage (Battery Protection)</b>				
<b>Start-up time (Input Voltage = 2V)</b>	9	10	11	ms

Parameter	Temperature	Voltage
	T < 40 $^{\circ}$ C	4.2 V
<b>Output floating voltage ranges</b>	40 $^{\circ}$ C < T < 50 $^{\circ}$ C	4.1 V
	50 $^{\circ}$ C < T < 60 $^{\circ}$ C	4.0 V
	60 $^{\circ}$ C < T < 60 $^{\circ}$ C	3.9 V
	70 $^{\circ}$ C < T	3.8 V
<b>Under-lockout voltage</b>	Disconnect with load when battery voltage $V_{ba}$ is lower than 3.2V and connect with load when $V_{ba}$ is higher than 3.5V	

## 8. TYPICAL PERFORMANCE

### 8.1 START UP RESPONSE

The self-start functionality can start circuit operation even when a battery or a supercapacitor is fully discharged. Fig. 1 shows the self-starting performance of self-start controller. When the start-up voltage becomes nonzero and starts to increase (upper line), the PWM generated by impedance matching controller is activated in 10 ms (bottom line).

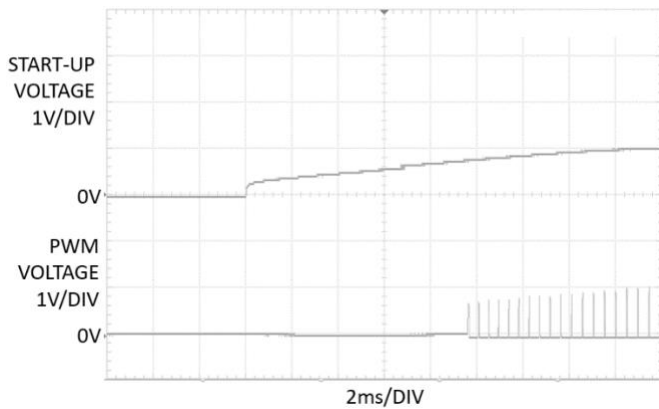

Figure 1. Start-up response of self-start controller

### 8.2 OVER-DISCHARGE PROTECTION

A under-voltage lockout (UVLO) function in SSIM-100 is included to prevent an over discharge of the battery. Fig. 2 shows the transient response of over-discharge protection. When Battery voltage at J2 (upper line) is lower than 3.2V, SSIM-100 disconnect the load at J3 (bottom line) to prevent over-discharge of battery. When battery voltage is higher than 3.5V, SSIM-100 connect the load to supply the power.

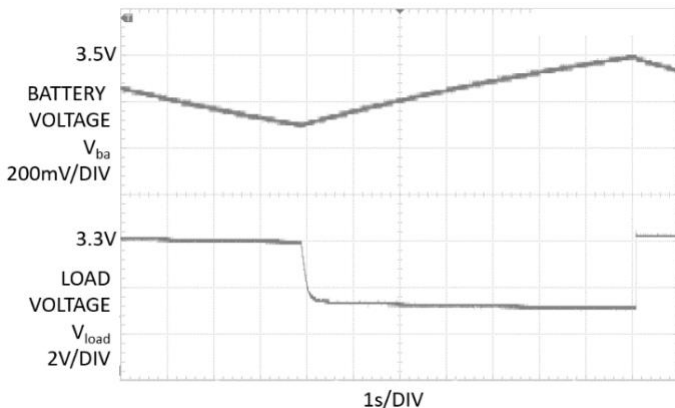

Figure 2. Transient response of over-discharge protection

### 8.3 EFFICIENCY

SSIM-100 has selectable impedance matching capability, which can be optimized based on user's application. Fig. 3 shows the efficiency vs input voltage and power with different impedance matching values. efficiency is defined as

$$\text{Efficiency} = \frac{\text{Charging power to battery}}{\text{Maxium power generated by energy harveser}}$$

As input voltage increases, efficiency increases. Maximum efficiency, 80 % is appeared after 7 V of input voltage.

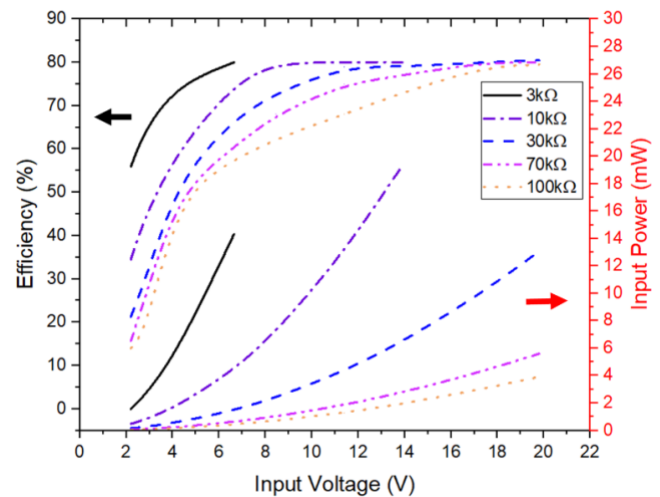

Figure 3. Efficiency vs. Input Voltage / Power

## 9. TECHNICAL DISRIPTION

SSIM-100 has a DC-DC converter for impedance matching. The impedance of harvester must match the load impedance to maximize power transfer to the load, namely impedance matching. However, electrical loads (such as a battery) typically have 10-1000 times lower impedance than a piezoelectric harvester. Thus, the charging efficiency without impedance matching circuit is extremely low. Input impedance of buck-boost converter can be emulated to match the impedance with harvester using PWM (pulse width modulation) control. Depend on the switching frequency and duty cycle of PWM, the input impedance of DC-DC converter can be tuned to match that of the harvester.

## 10. APPLICATION

### 10.1 WIRELESS SENSOR NODE

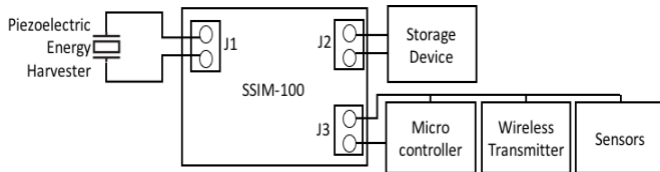

Figure 4. Example 1: Wireless sensor node with SSIM-100

SSIM-100 can be integrated with wireless sensor node, which consists of microcontroller, wireless transmitter, and sensors. Fig.4 shows first configuration of wireless sensor node with SSIM-100. J2 is output of impedance matching circuit and can be connected with storage device. Built-in linear regulator

### 10.2 CASE STUDY

Table 1

Input	Harvester (S230)		SSIM-100	LTC358x
Acceleration (9.8 m/s <sup>2</sup> )	Tip Mass (g)	Z (kΩ)	Output Power (mW)	Output Power (mW)
3.05	2	14	11.82	3.29
2.45	4	17	11.66	3.13
1.90	6	24	11.45	3.13
1.45	8	29	10.67	3.19

In the case study, SSIM-100 was compared to commercial piezoelectric energy harvesting converter with piezoelectric energy harvester.

- Piezoelectric energy harvester: PIEZO.COM, S230-J1FR-1808XB.
- Commercial piezoelectric energy harvesting circuit: Analog Device, LTC-358x.
- Shaker is used to generate various excited frequency, for testing the cantilever type harvester (S230).
- Testing is performed with different resonance frequency of piezoelectric energy harvester.

First, output power of harvester at optimum loads (14-29kΩ) was measured. Then, output power of two energy harvesting circuits are compared to evaluate output power. Table 1 shows measurement of energy harvester and energy harvesting circuits. Test results shows that output power ranges of energy harvester were 10-11 mW. In this condition, output power ranges of SSIM-100 were 8.7 – 9.46 mW, but LTC-358x is 3.19-

(LDO) regulates the voltage, and microcontroller, wireless transmitter and sensor can be connected with J3. J3 is selectable output (1.8V, 2.5V, 3.3V) pin and can be selected based on supply voltage of wireless sensor node.

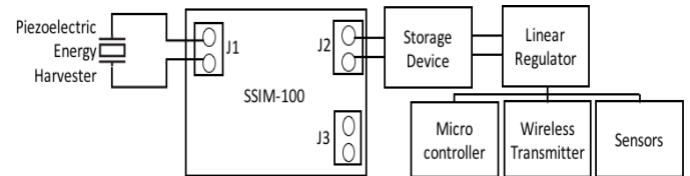

Figure 5. Example 2: Wireless sensor node with SSIM-100

Second configuration of wireless sensor node with SSIM-100 is shown in Fig. 5. When LDO is integrated in user's wireless sensor node, J2 is connected with storage device of wireless sensor node without connection of J3.

3.29 mW. Overall, SSIM-100 shows 80% of efficiency as shown in Figure 5.

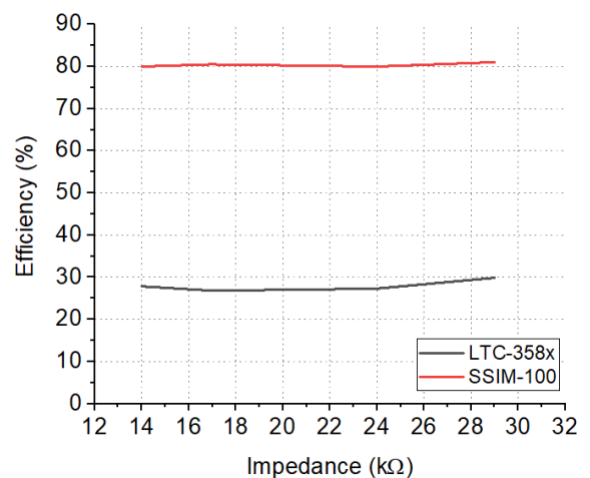

Figure 6. Comparison results of efficiency at various optimum loads



# Life Tag

Unplan Obsolescence

## 11. PHYSICAL DIMENSION

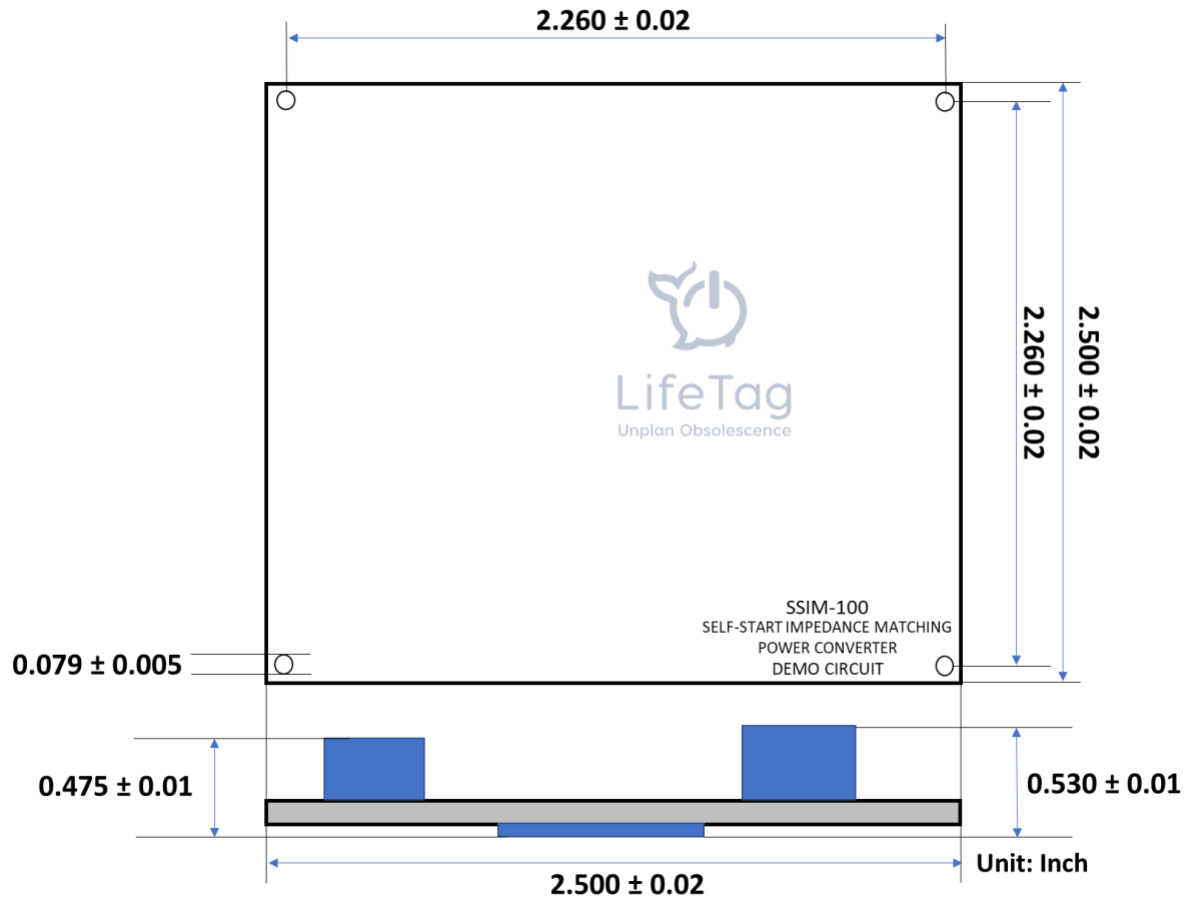

## 12. ORDER INFORMATION

Product	Impedance Matching Ranges	Size	Comment
SSIM-100	1.4 k $\Omega$ - 200 k $\Omega$	2.50 (W) $\times$ 2.50 (L) $\times$ 0.53 (H) inches	EVAL (3 PCBs)
SSIM-101	100 $\Omega$ - 10 k $\Omega$	0.59 (W) $\times$ 0.98 (L) $\times$ 0.47 (H) inches	DIY (3 PCBs)
SSIM-102	10 k $\Omega$ - 60 k $\Omega$	0.59 (W) $\times$ 0.98 (L) $\times$ 0.47 (H) inches	DIY (3 PCBs)
SSIM-103	50 k $\Omega$ - 150 k $\Omega$	0.59 (W) $\times$ 0.98 (L) $\times$ 0.47 (H) inches	DIY (3 PCBs)
SSIM-104	100 $\Omega$ - 150 k $\Omega$	0.59 (W) $\times$ 0.98 (L) $\times$ 0.47 (H) inches	KIT (3 PCBs)



Technical Engineer  
Phone: (510) 578-8849  
Email: [info@pyro-e.com](mailto:info@pyro-e.com)  
Address: 2079 E 15<sup>th</sup> St Ste 127,  
Los Angeles, CA 90021