



Que-2-TXT™  
Questions?  
scan to text us fast



# F72 PLASTIC LED SIGN RETROFIT LAMP

DOUBLE SIDE LIT, HIGH BRIGHTNESS

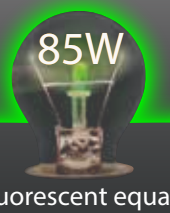

## specifications

Voltage	CRI	BASE	Lens	Heat Sink	L70 hours	Ambient Temp (F)	Power Factor	IP Rating	THC	Beam Angle
⚡ 100-277 V	83	R17D	double-side plastic	aluminum	50,000	-22°- 131°	>0.9	IP 64 except for base	<15%	360°

## select your lamp

Part Number	Color Temp	Consumption	Lumen Output	Efficacy	Length (pin to pin)	Diameter
GI-F72T10-CC85-R17D4	6000K	36W	4,320	120 lm / w	69.91"	1.28"

Warranty	Weight	Case QTY
6 years	2.98 lbs	10 pcs



## Features

- Rotatable base
- Rated for fully enclosed fixtures
- 50,000 hour LED lifespan based on IES LM-80 results and TM-21 calculations
- Double-side powered
- Designed for double sided signs
- Replaces F72T12/HO lamps

## Installation Diagram

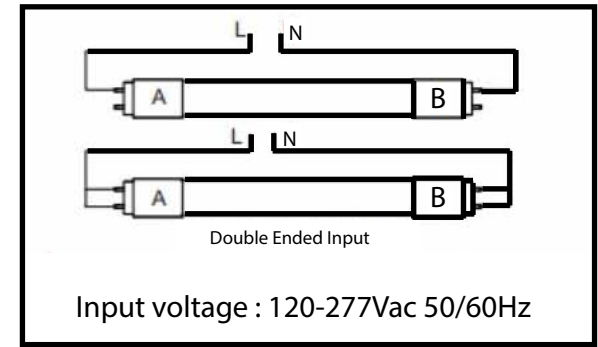

/greenignite  
@greenignite



www.greenignite.com



info@greenignite.com



1-877-560-3779