

Build Your Own Clone Classic Overdrive Kit Instructions



Warranty:

BYOC, LLC guarantees that your kit will be complete and that all parts and components will arrive as described, functioning and free of defect. Soldering, clipping, cutting, stripping, or using any of the components in any way voids this guarantee. BYOC, LLC guarantees that the instructions for your kit will be free of any major errors that would cause you to permanently damage any components in your kit, but does not guarantee that the instructions will be free of typos or minor errors. BYOC, LLC does not warranty the completed pedal as a whole functioning unit nor do we warranty any of the individual parts once they have been used. If you have a component that is used, but feel it was defective prior to you using it, we reserve the right to determine whether or not the component was faulty upon arrival. Please direct all warranty issues to: sales@buildyourownclone.com This would include any missing parts issues.

Return:

BYOC, LLC accepts returns and exchanges on all products for any reason, as long as they are unused. We do not accept partial kit returns. Returns and exchanges are for the full purchase price less the cost of shipping and/or any promotional pricing. Return shipping is the customer's responsibility. This responsibility not only includes the cost of shipping, but accountability of delivery as well. Please contact sales@buildyourownclone.com to receive a return authorization before mailing.

Tech Support:

BYOC, LLC makes no promises or guarantees that you will successfully complete your kit in a satisfactory manner. Nor does BYOC, LLC promise or guarantee that you will receive any technical support. Purchasing a product from BYOC, LLC does not entitle you to any amount of technical support. BYOC, LLC does not promise or guarantee that any technical support you may receive will be able to resolve any or all issues you may be experiencing.

That being said, we will do our best to help you as much as we can. Our philosophy at BYOC is that we will help you only as much as you are willing to help yourself. We have a wonderful and friendly DIY discussion forum with an entire section devoted to the technical support and modifications of BYOC kits.

www.buildyourownclone.com/board

When posting a tech support thread on the BYOC forum, please post it in the correct lounge, and please title your thread appropriately. If everyone titles their threads "HELP!", then it makes it impossible for the people who are helping you to keep track of your progress. A very brief description of your specific problem will do. It will also make it easier to see if someone else is having or has had the same problem as you. The question you are about to ask may already be answered. Here are a list of things that you should include in the body of your tech support thread:

1. A detailed explanation of what the problem is. (not just, "It doesn't work, help")
2. Pic of the top side of your PCB.
3. Pic of the underside of your PCB.
4. Pic that clearly shows your footswitch/jack wiring and the wires going to the PCB
5. A pic that clearly shows your wiring going from the PCB to the pots and any other switches(only if your kit has non-PC mounted pots and switches)
6. Is bypass working?
7. Does the LED come on?
8. If you answer yes to 6 and 7, what does the pedal do when it is "on"?
9. Battery or adapter.(if battery, is it good? If adapter, what type?)

Also, please only post pics that are in focus. You're only wasting both parties' time if you post out of focus, low res pics from your cell phone.

Revision Notes:

Rev 1.0 There are no known errors.

Copyrights:

All material in this document is copyrighted 2010 by BYOC, LLC

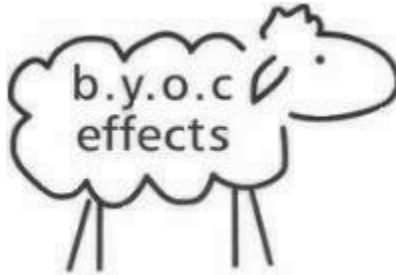

CLASSIC OVERDRIVE KIT INSTRUCTION INDEX

Parts Checklist.....	page 4 - 5
Populating the Circuit Board.....	page 6 - 16
Main PCB Assembly.....	page 17 - 19
Wiring.....	page 20 - 23
Installing the IC's and Finishing Up.....	page 24
Operation Overview.....	page 25
Schematic.....	page 26 - 27

Parts Checklist for BYOC Classic Overdrive Kit

Resistors:

- 1 - 100ohm (brown/black/black/black/brown)
- 1 - 220ohm (red/red/black/black/brown)
- 4 - 1k (brown/black/black/brown/brown)
- 2 - 4k7 (yellow/purple/black/brown/brown)
- 7 - 10k (brown/black/black/red/brown)
- 1 - 51k (green/brown/black/red/brown)
- 3 - 511k (green/brown/brown/orange/brown)

Capacitors:

- 1 - 51pf ceramic disc (small round orange)
- 1 - 22n or .022 μ film (223)
- 1 - 47n or .047 μ film (473)
- 1 - 100n or 0.1 μ film (104or μ 1)
- 2 - 0.22 μ tantalum (mustard yellow colored w/ red writing)
- 2 - 1 μ film (larger film caps)
- 1 - 10 μ f aluminum electrolytic
- 1 - 47 μ f aluminum electrolytic
- 1 - 100 μ f aluminum electrolytic

Diodes:

- 2 - 1N4148 (small orange glass with black stripe)

Transistors:

- 2 - MPSA18, 2N5088, 2N3904, or 2N2222

IC's:

- 1 - JRC4558
- 1 - 8 pin socket

Potentiometers: Be sure to snap off the small tab on the side of each panel mounted pot.

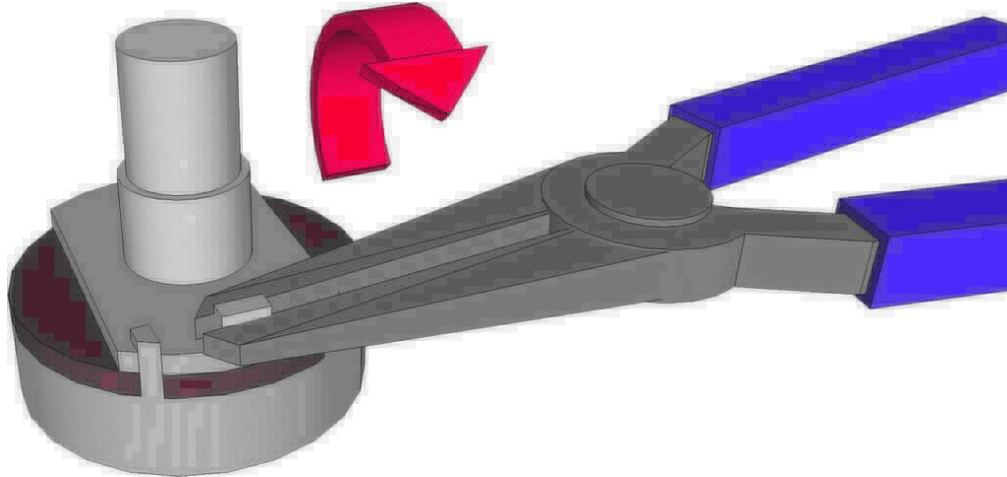

- 1 - B100k linear (LEVEL)
- 1 - B25k linear (TONE)
- 1 - A500k audio (DRIVE)

Hardware:

- 1 - drilled enclosure w/ 4 screws
- 1 - byoc classic over drive PCB
- 1 - 3PDT footswitch
- 3 - knobs
- 1 - AC adaptor jack
- 1 - 1/4" mono jack
- 1 - 1/4" stereo jack
- 1 - red LED
- 1 - battery snap
- 4 - bumpers
- hook-up wire

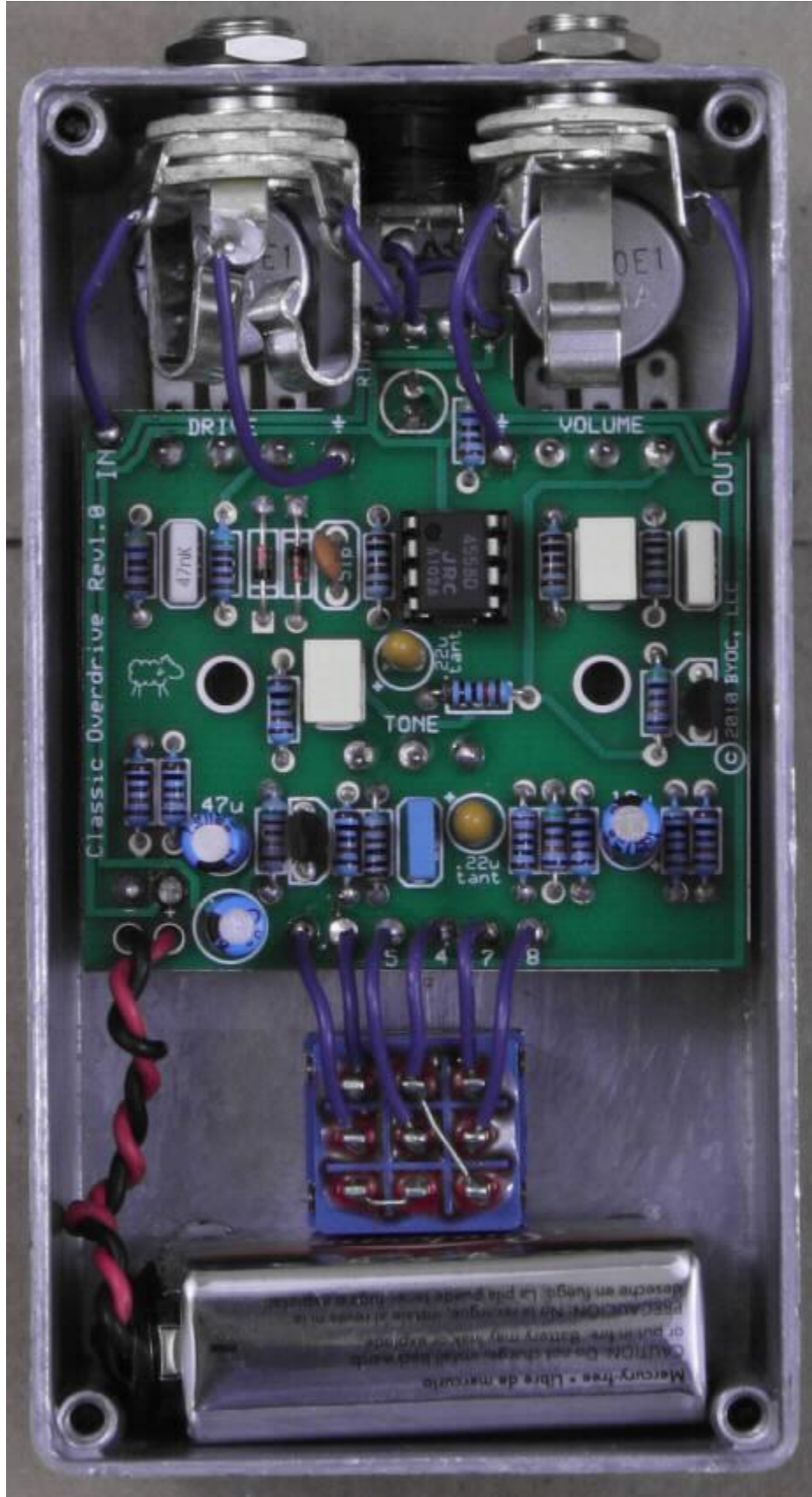

Classic Overdrive Rev1.8

DRIVE

VOLUME

OUT

47nK

25u Tant

47u

22u Tant

5 4 7 8

© 2018 BYOC, LLC

Mercury-free • Libre de mercure
CAUTION: Do not charge, short, heat, or
or put in fire. Battery may leak or explode.
PRECAUTION: No recharging, intake of toxic or
desèche en feu. La pile peut fuir, se surchauffer
ou exploser.

Populating the Circuit Board

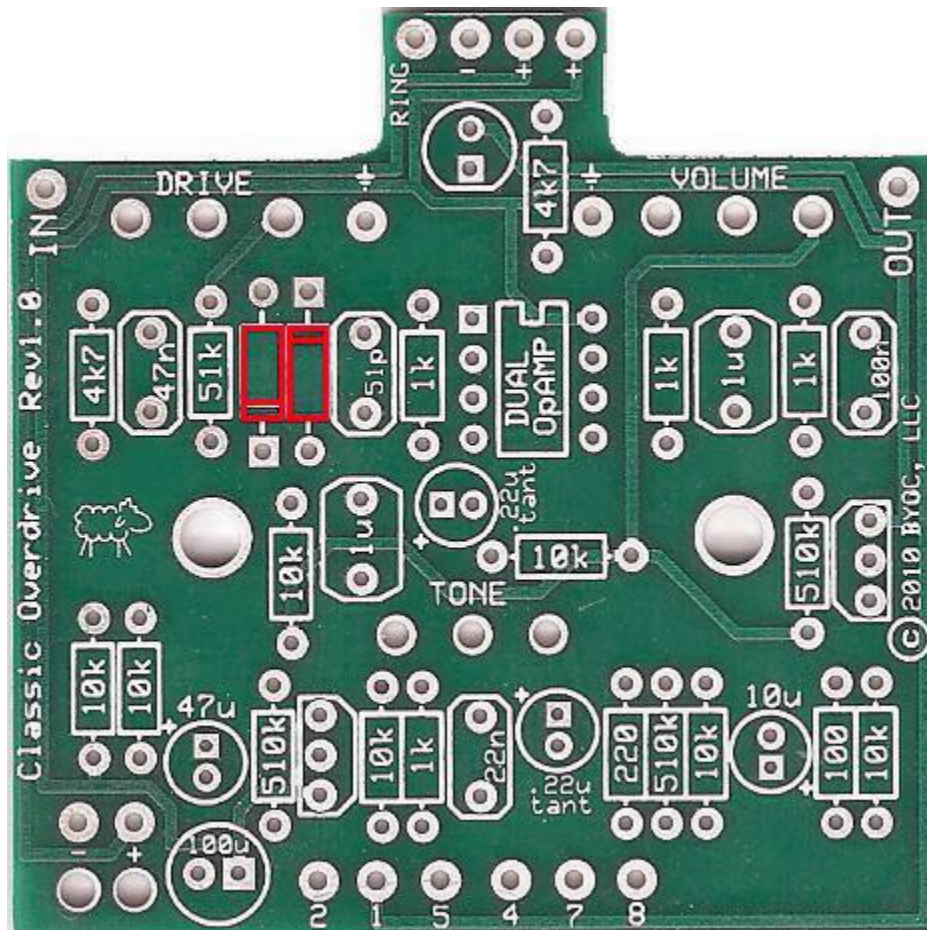

STEP 1: Add the diodes. Be sure to match the end of the diode with the stripe to the layout on the PCB. The striped end should go in the square solder pad.

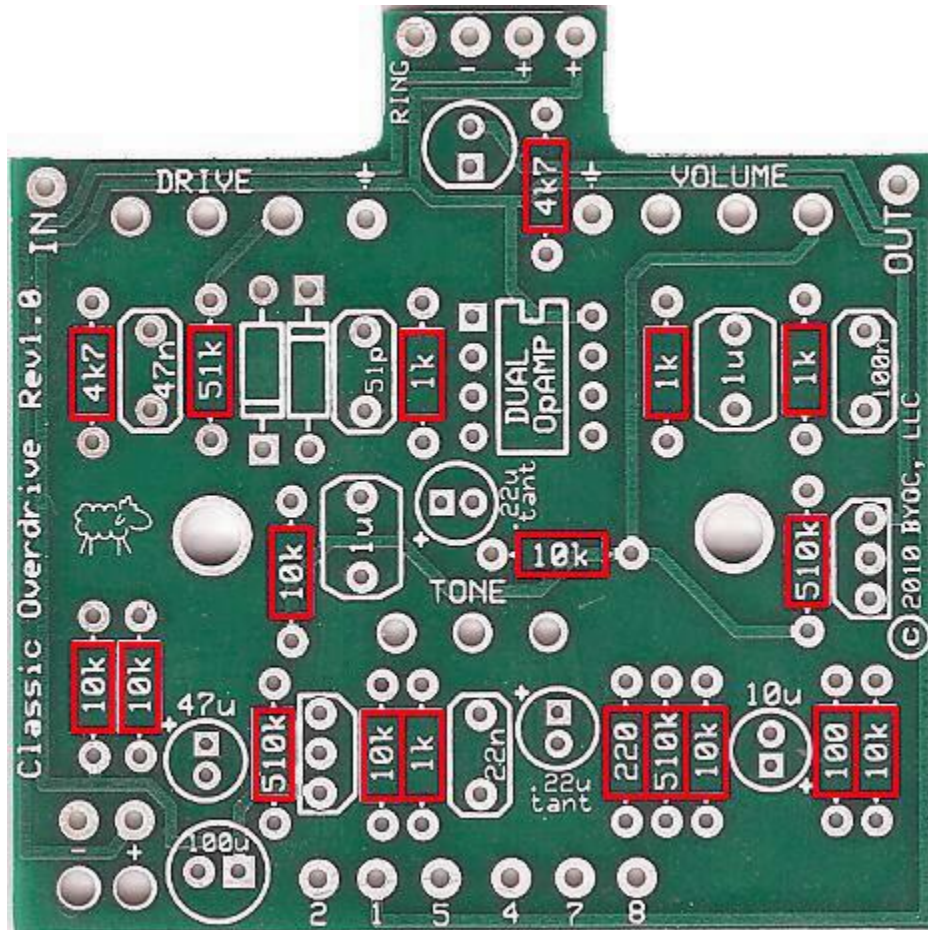

STEP 2: Add the resistors. Resistors are not polarized, so it does not matter which end goes in which solder pad. Take your time and be sure not to confuse similarly banded resistors such as the 51k with the 51k or the 100ohm with the 1k. Also note that the PCB says 510k, but your kit will come with 511k resistors. Use the 511k resistors in the 510k spaces.

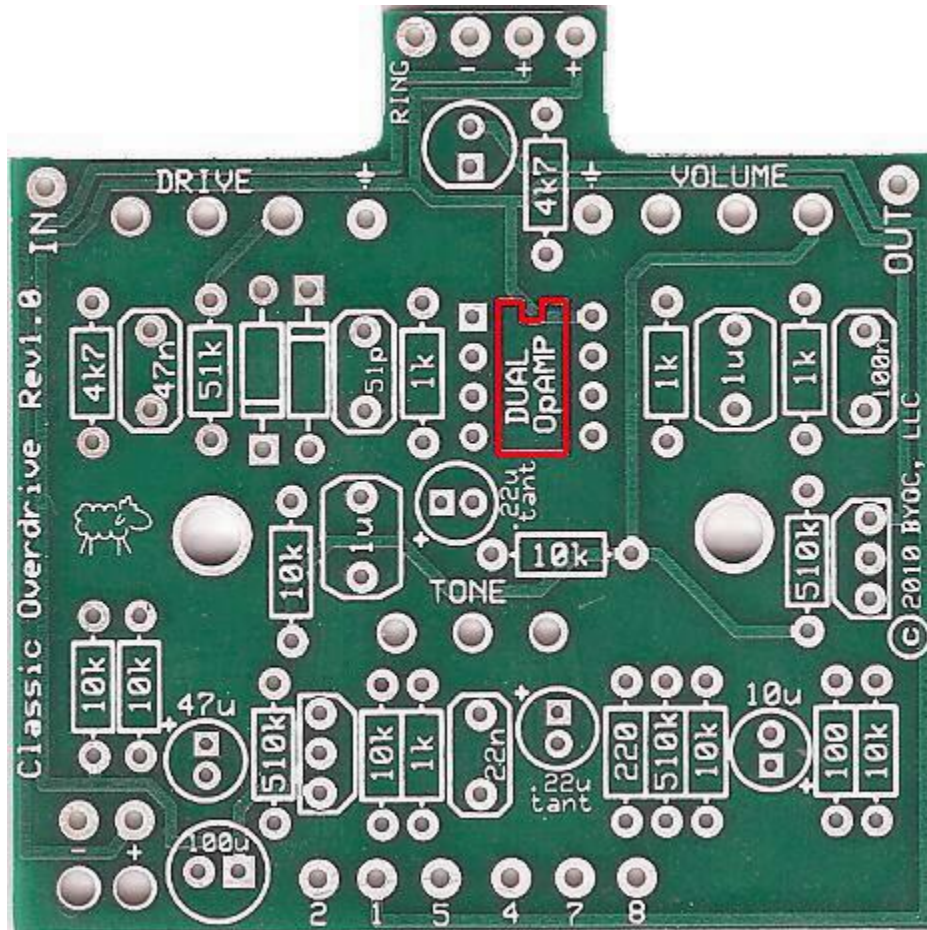

STEP 3: Add the 8 pin IC socket. **ONLY SOLDER THE SOCKET! NOT THE ACTUAL IC!** This is a socket. The sockets get soldered to the PCB. The ICs get inserted into the sockets. The actual IC chip itself, never gets soldered. You will insert the IC into the socket after the entire pedal has been built.

See page 21 for instructions on how to install the IC.

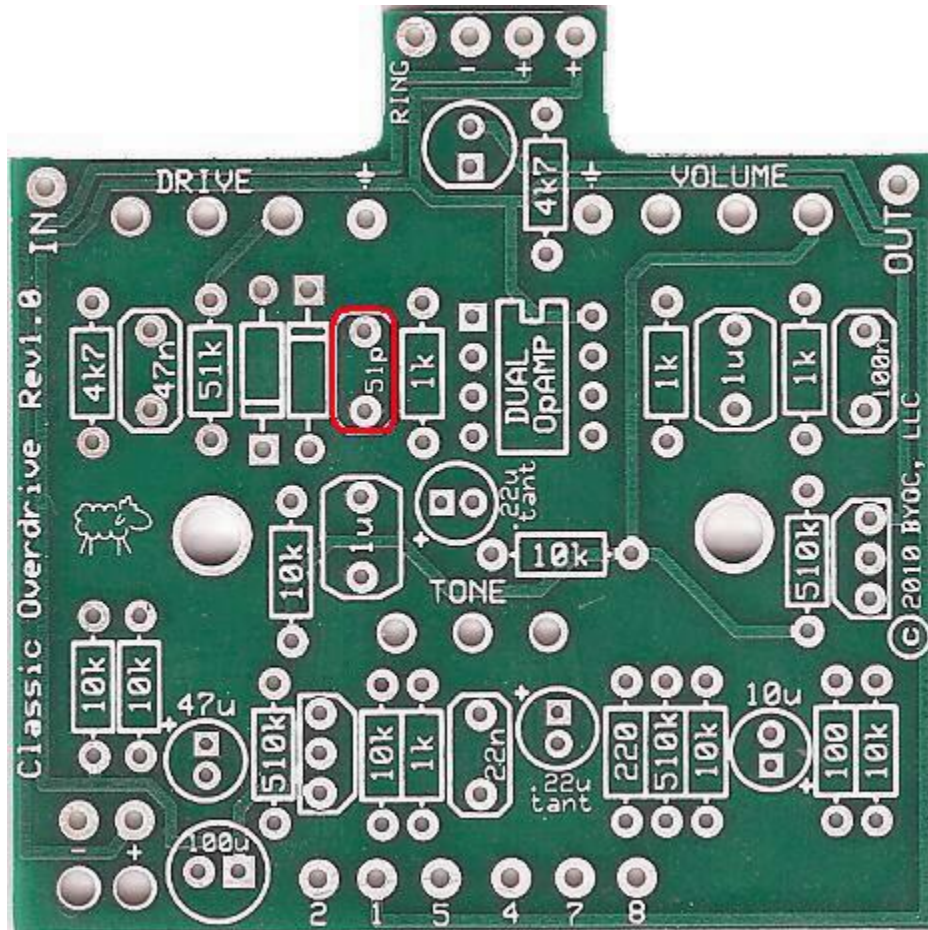

Step 5: Add the ceramic disc capacitor. Ceramic disc caps are not polarized and can be inserted into the pcb in either direction.

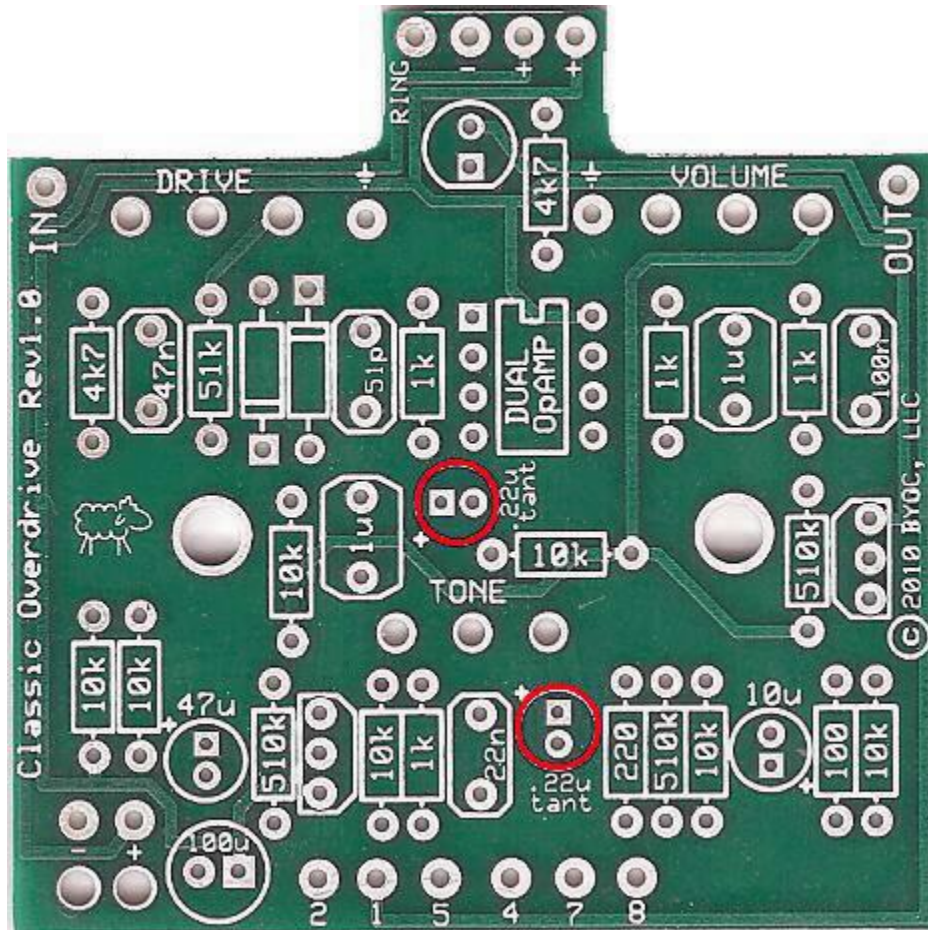

Step 6: Add the tantalum capacitors. Tantalum caps are polarized. The positive lead goes in the square solder pad hole. The positive side will have a stripe running down one side and the “+” symbol above the positive lead.

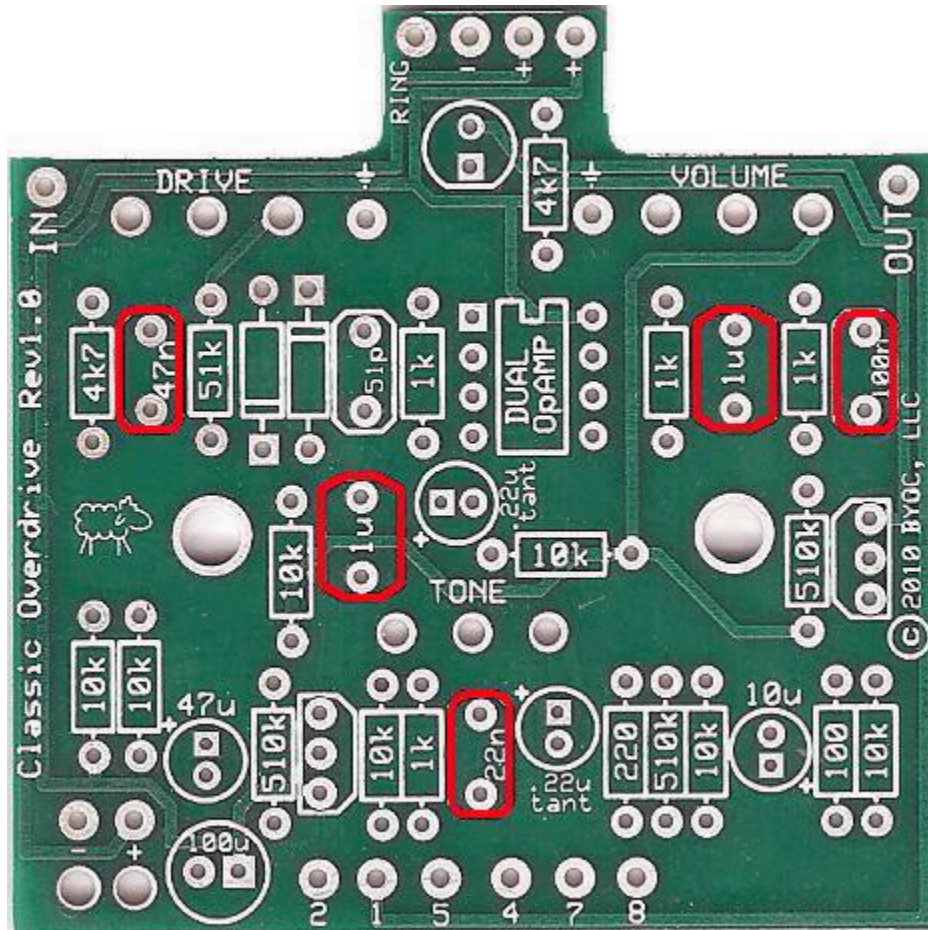

Step 5: Add the film capacitors. These are not polarized and can be inserted into the PCB either way.

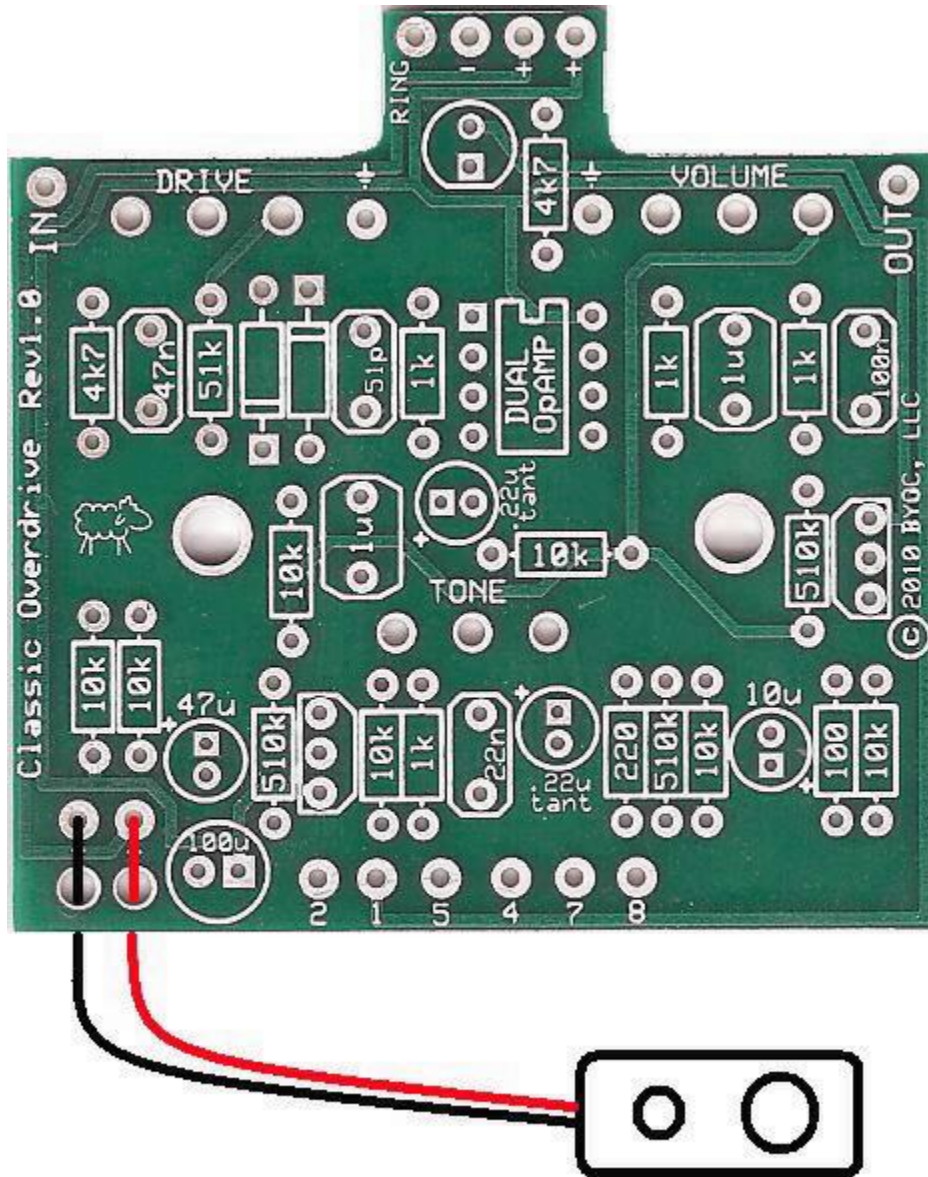

Step 7: Add the battery snap. Thread the solder ends of the battery snap into the strain relief holes from the bottom solderside of the PCB and out through the top. Insert the solder ends of the battery snap wires into the topside of their respective solder pads. Solder on the bottom side of the PCB. Remember the red wire goes in the “+” hole and the black wire goes in the “-” hole.

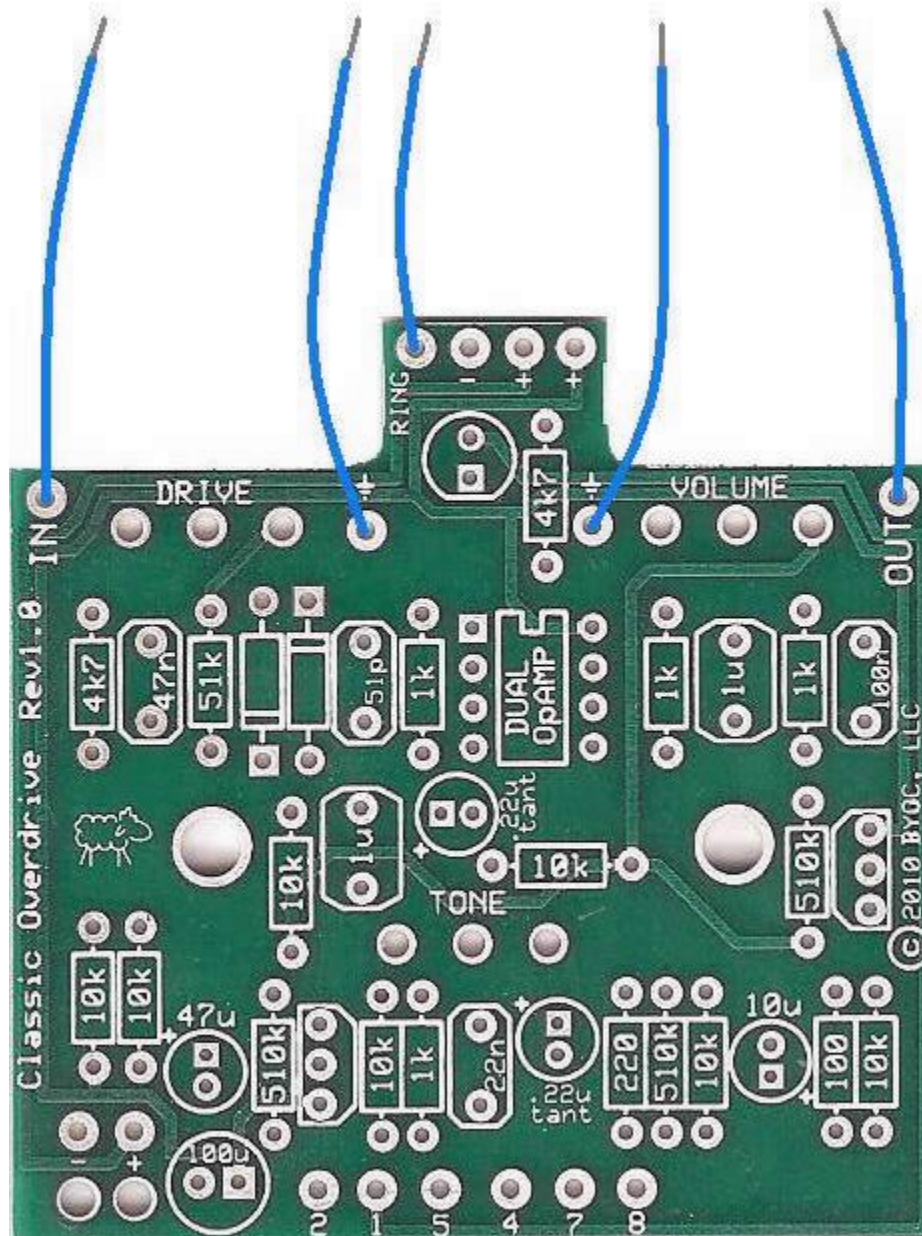

Step 8: Add wires to the IN, OUT, RING, and two Ground eyelets. Start by cutting four 2.5" pieces of wire and one 1.5" piece of wire. Strip 1/4" off each end and tin the ends. Tinning means to apply some solder to the stripped ends of the wires. This keeps the strands from fraying and primes the wire for soldering. Solder a 2.5" piece of wire to each of the IN, OUT, and Ground eyelets on the PCB. Solder the 1.5" piece of wire to the RING eyelet on the PCB. Load the wires in from the top and solder on the bottom of the PCB.

Main PCB Assembly

Step 1: Mount the DC adaptor jack to the enclosure.

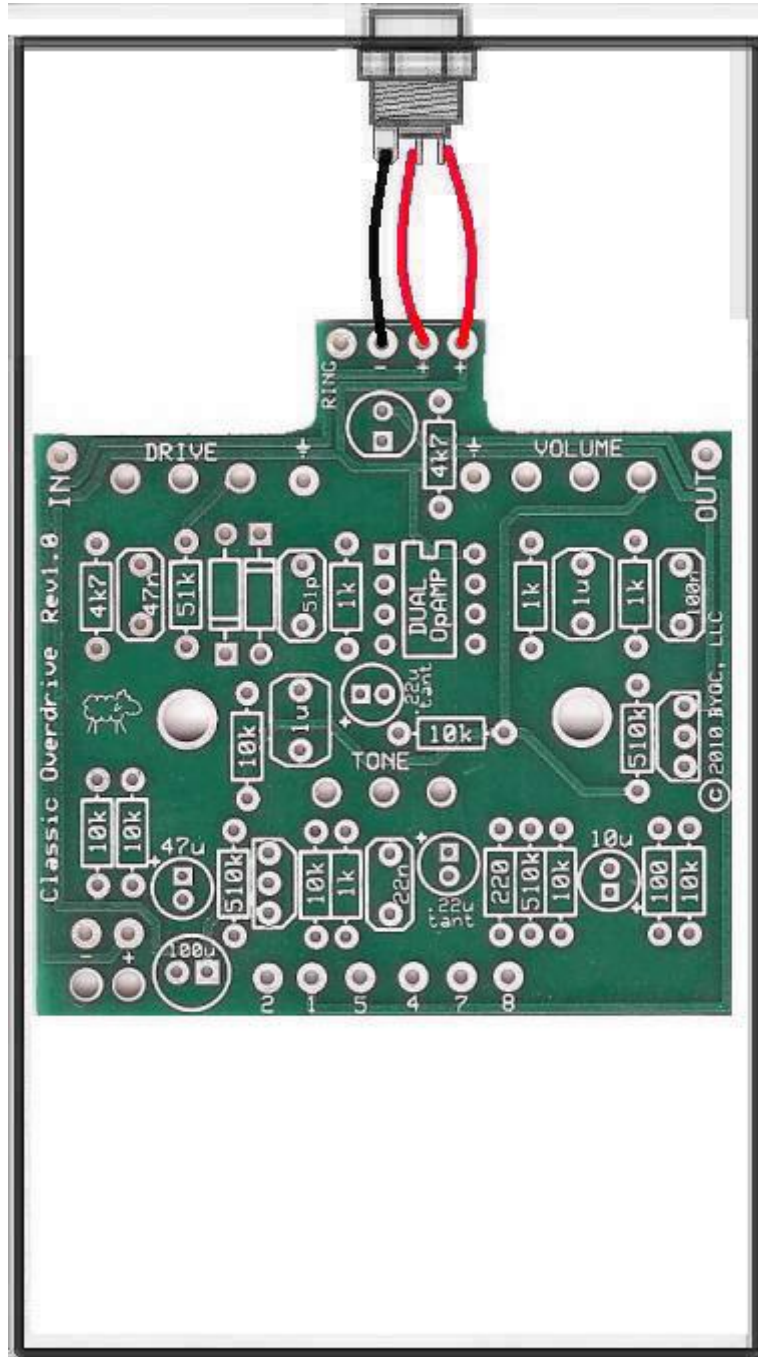

Step 2: Connect the TIP (negative) terminal of the DC adaptor jack to the “-” eyelet on the PCB with 2 inches of hook up wire. Connect the SLEEVE of the DC adaptor jack to the “+” eyelet on the far right side of the PCB with 2 inches of hook up wire. Connect the battery disconnect terminal of the DC adaptor jack to the “+” eyelet more towards the center of the PCB with 2” of hookup wire. Load the wires in from the bottom of the PCB and solder on the topside.

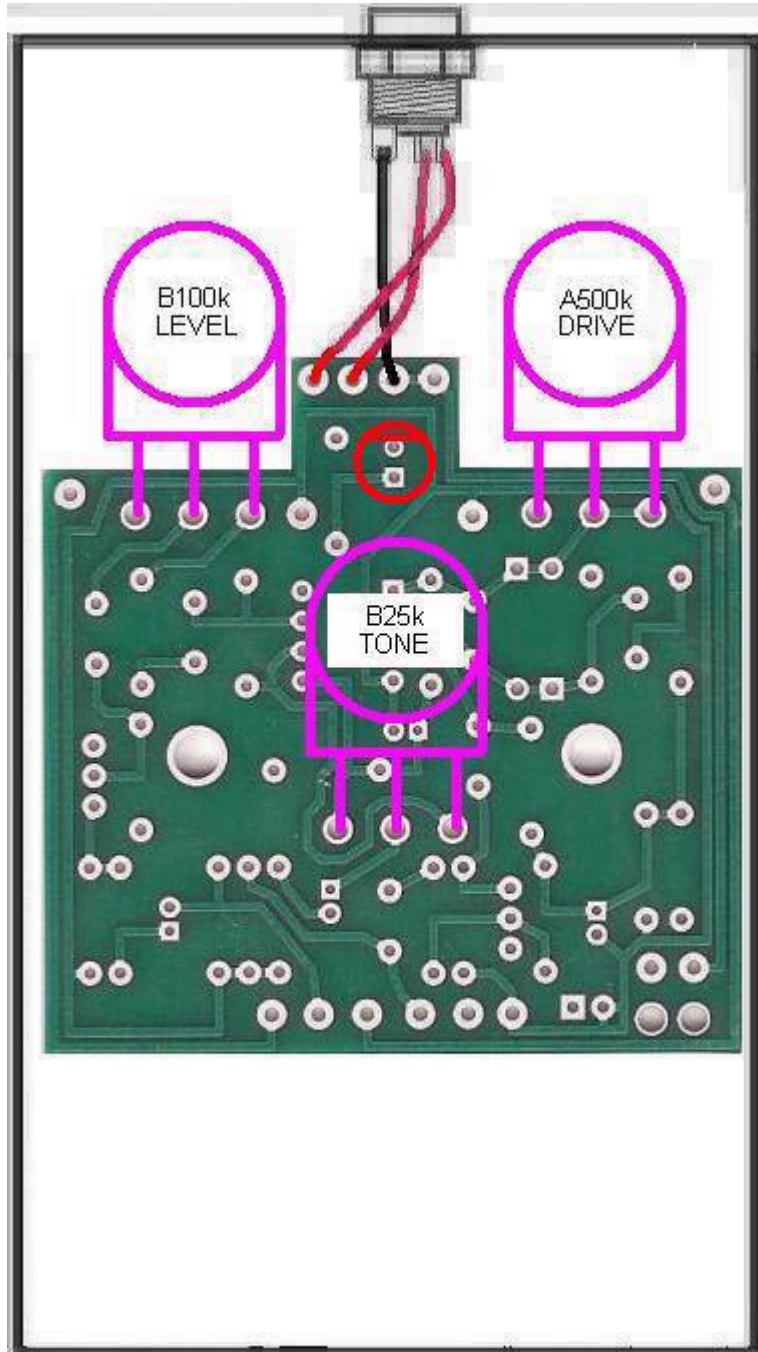

Step 3: Flip the PCB over so that the bottom or solder side is up. Insert the B100k(LEVEL),A500k(DRIVE), B25K(TONE) potentiometers, and the LED into the bottom side of the PCB. **DO NOT SOLDER ANYTHING YET!!!** The LED will have one lead that is longer than the other. The longer lead goes in the hole with the square solder pad.

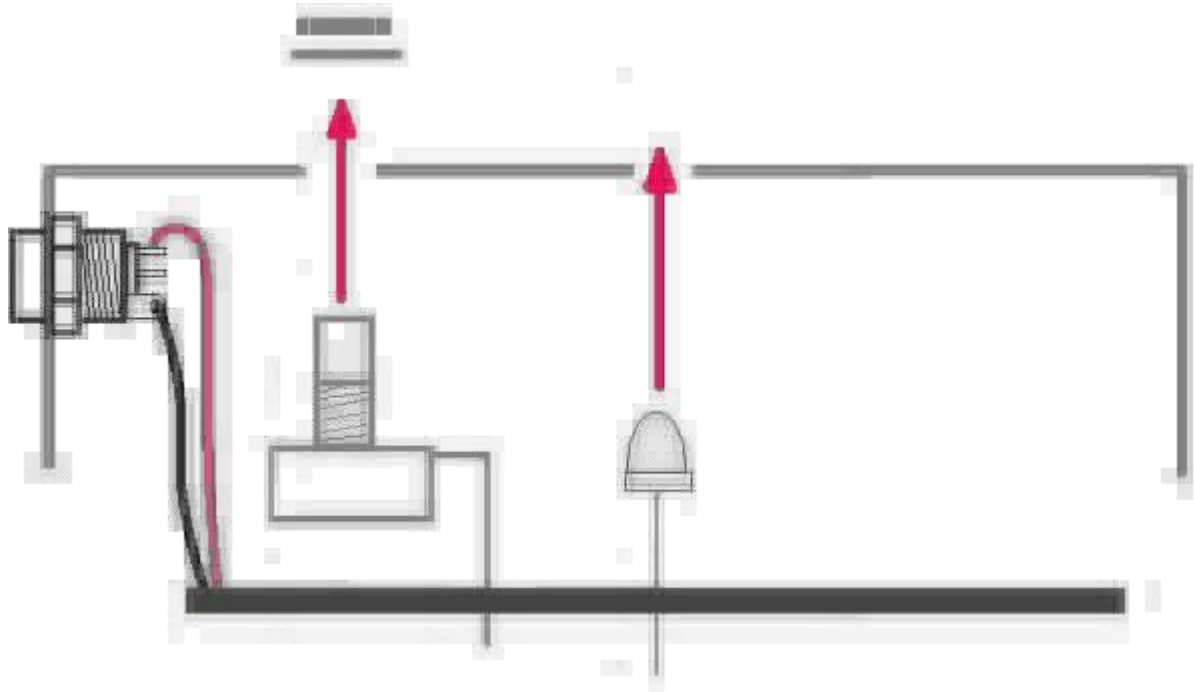

Step 4: Hold the PCB in one hand so that the component side of the PCB is in the palm of your hand and the bottom side with the pots, toggle switch and LED is facing up. Now use your other hand to guide the predrilled enclosure onto the PCB assembly so that the pots and LED all go into their respective holes. Once the PCB assembly is in place, secure it by screwing on the washers and nuts for the pots and toggle switch. Only tighten them with your fingers. You do not want them very tight yet. Be sure to keep your hand on the PCB so that it does not fall off the PCB mounting posts of the pots and toggle switch.

Step 5: Turn the entire pedal over so that the component side of the PCB is facing up. Lift the PCB up off the pots and toggle switch about 2mm just to make sure that the back of the PCB does not short out against the pots. Make sure the PCB is level and symmetrically seated inside the enclosure.

Step 6: Solder the pots and LEDs. You will solder these parts on the component side of the PCB. After you have soldered them in place, be sure to tighten up their nuts.

Wiring

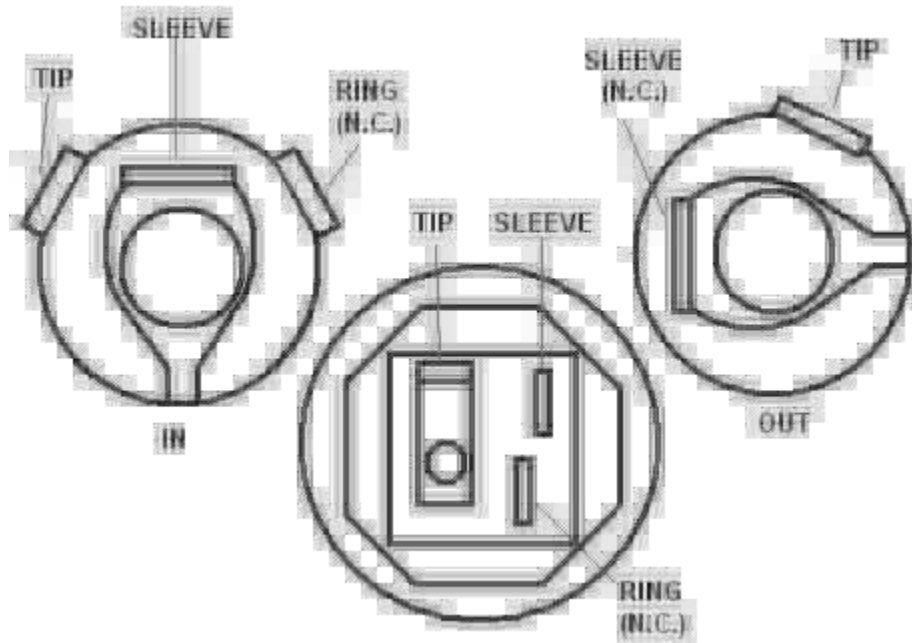

Step 1: Install the 1/4" jacks to the enclosure. Be sure to turn the OUT jack a 1/4 turn counter clockwise so that solder terminal for the tip does not short out against the enclosure.

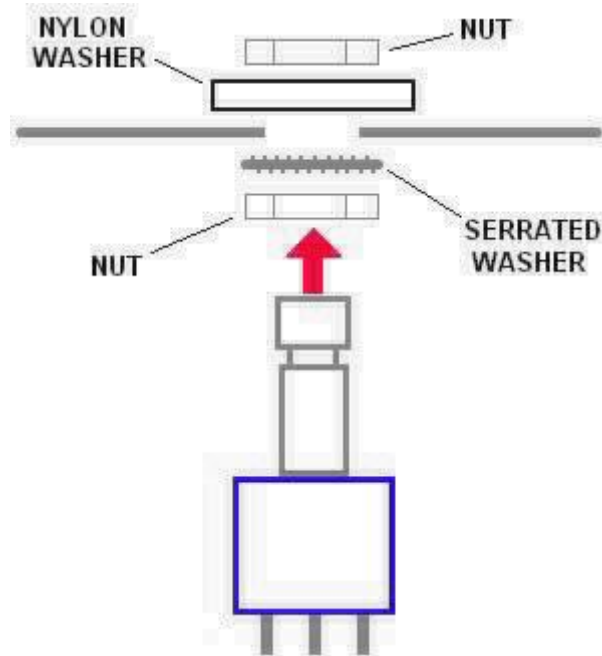

Step 2: Install the footswitch. Orient the footswitch so that the flat sides of the solder lugs are like the diagram below. NOTE: There are no actual number markings on the footswitch. There are two correct ways you can orient the footswitch. They are both 180

degrees of each other. Either way is fine. It does not matter as long as the flat sides of the solder lugs are running horizontal, not vertical.

Footswitch Solder Lug Designations

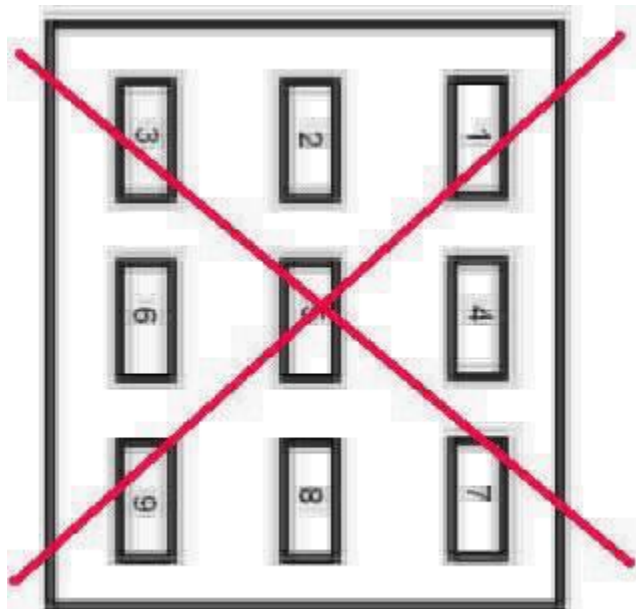
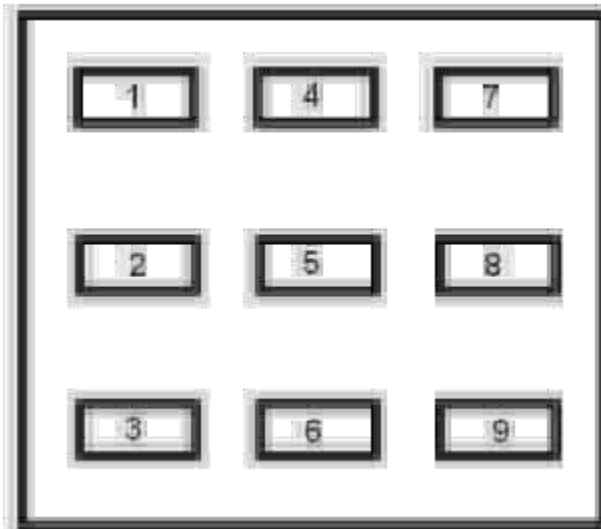

- Cut 3 x 2" pieces of wire. Strip 1/4" off each end. These will be used to connect the tip and sleeve of the IN jack and the tip of the OUT jack to the PCB.
- Cut 1 x 1.5" piece of wire. Strip 1/4" off each end. This will be used to connect the ring of the IN jack to the ring eyelet on the PCB.

Step 5: Solder one end of the pre-cut and pre-stripped wires to the footswitch.

Step 6: Insert the other remaining ends of the pre-cut and pre-stripped wires into the topside of the PCB and solder. You can solder these on the topside as well. It is easier this way, but you may burn a small amount of the PVC coating on the wires. This is purely aesthetic and won't damage the wires in anyway. But you can avoid this by removing the PCB assembly and footswitch from the enclosure entirely (the PCB assembly will still be attached to the enclosure via the DC jack wiring) so that you have access to solder the underside of the PCB.

Installing the IC's and Finishing Up

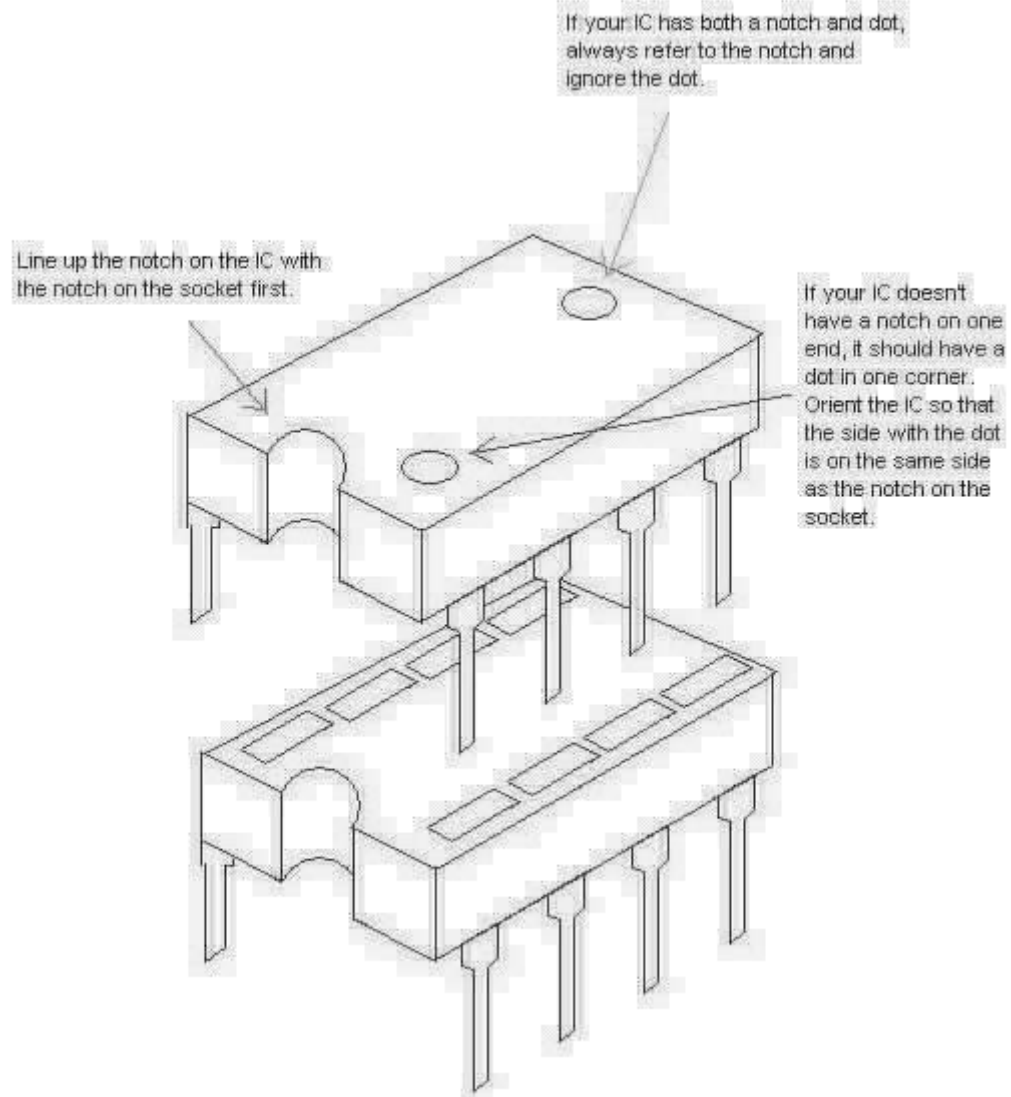

Don't forget to put the cover on the enclosure and apply the bumpers to the cover if you like to use them.

Operating Overview

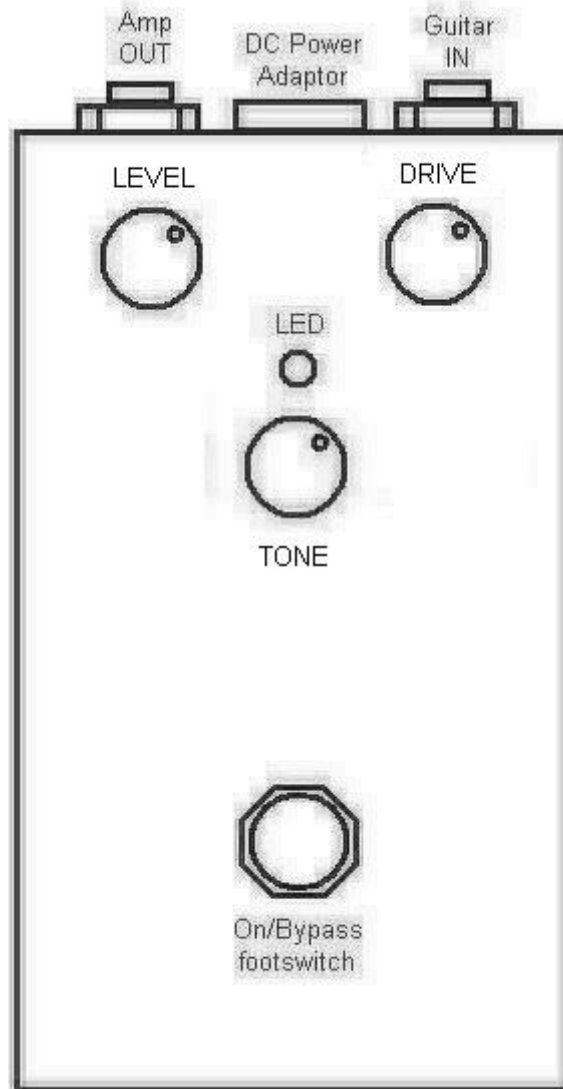

LEVEL, DRIVE, & TONE: Do you really need an explanation of what these knobs do?

DC power supply - Use a 2.5mm negative tip 9VDC adaptor (this is your standard guitar fx style adaptor). If using battery power, only use a single 9V battery.

Current Draw - 2.5mA

Input Impedance - 511k ohms

Output Impedance - 10k ohms

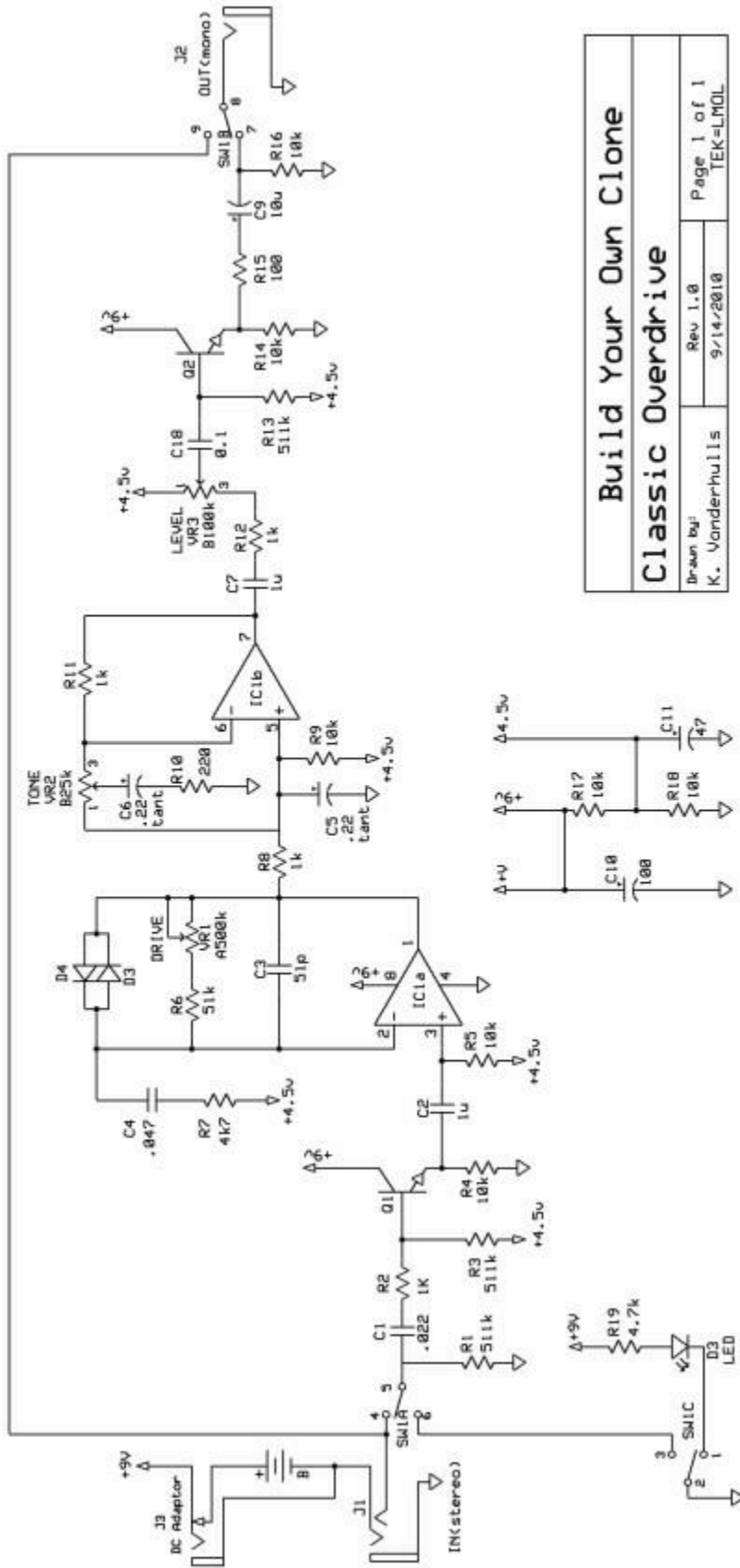

Build Your Own Clone
Classic Overdrive

Drawn by: K. Vanderhullis	Rev 1.8 9/14/2010
Page 1 of 1 TEK=LMDL	

Please visit
<http://buildyourownclone.com/board>
for any technical support

copyright 2010
B.Y.O.C., LLC