

# ODS-1500

## 1200...1500 VA DC/AC INVERTER

### GENERAL FEATURES:

- Sine wave output voltage
- Selectable output frequency: 50/60Hz
- Adjustable output voltage
- High input-output isolation 3000Vrms
- Remote inhibit
- Remote control via RS232
- Alarm by isolated relay contacts
- Remote off opto-coupled
- Optional railway version EN50155
- Fire and smoke: EN45545-2 approved
- Efficiency up to 91%



	<b>12Vdc</b> 10 ... 15V	<b>24Vdc</b> 16.8 ... 30V	<b>36Vdc</b> 25.2 ... 45V	<b>48Vdc</b> 33.6 ... 60V	<b>72Vdc</b> 50.4 ... 90V	<b>110Vdc</b> 77 ... 138V
<b>120Vac</b>	<b>ODS-1500-7121</b> 1200 W	<b>ODS-1500-7123</b> 1500 W	<b>ODS-1500-7124*</b> 1500 W	<b>ODS-1500-7125</b> 1500 W	<b>ODS-1500-7126</b> 1500 W	<b>ODS-1500-7127</b> 1500 W
<b>230Vac</b>	<b>ODS-1500-7111</b> 1200 W	<b>ODS-1500-7113</b> 1500 W	<b>ODS-1500-7114</b> 1500 W	<b>ODS-1500-7115</b> 1500 W	<b>ODS-1500-7116</b> 1500 W	<b>ODS-1500-7117</b> 1500 W

\*References subject to special MOQs and lead times

**INPUT**

Input voltage range	-30, +25% Vin nom, (10 ... 15Vdc)*
Maximum input ripple	5% Vin nom (Vrms, 100Hz)

**OUTPUT**

Output voltage	120 / 230Vac sinusoidal
Output frequency	50 / 60Hz ± 0.25Hz
Load regulation	< 4%
Line regulation	< 2 % Vin -25% ... +25%, < 10% Vin -30% ... +30%
Output wave distortion THD	< 2% (average of 16 samples)
Output HF ripple	< 2.5%

**ENVIRONMENTAL**

Storage temperature	-25 ... 80°C
Operating temperature full load	-25 ... 55°C(EN50155 OT1)
Operating temperature 50% load	-25 ... 70°C(EN50155 OT3)
Relative humidity	5 ... 95%
Cooling	Controlled internal fan
MTBF (MIL-HDBK-217-E; G <sub>b</sub> , 25°C)	130.000 h

**EMC**

Immunity according	EN61000-6-2 (EN50121-3-2)
Emissions according	EN61000-6-4 (EN50121-3-2)

**SAFETY**

Dielectric strength: Input /output	3000 Vrms / 50Hz / 1min
Dielectric strength: Output / ground	1500 Vrms / 50Hz / 1min
Dielectric strength: Input / ground	500 Vrms / 50Hz / 1min
Safety according to	EN60950-1, EN62368-1
Fire and smoke	EN45545-2 approved

**MECHANICAL**

Weight	3800 g
--------	--------

**PROTECTIONS**

Against overloads	Current and I <sup>2</sup> T limited (see overload protection)
Against over-temperature	Shutdown with auto-recovery

**CONTROL**

Output OK LED	Green
Alarm LED	Red
Output failure alarm	Isolated contact relay open when alarm (<0.3A at 150Vdc)
Remote OFF	Off applying 14,4 ... 137.5Vdc, Impedance > 22k5 Ω (See Note-1)
Status and programming	RS232 port

Note-1: Only available depending on HW version. Former models were 4 ... 30V, Impedance 3k3Ω



## ORDERING CODES

Model	Input voltage DC [V]	Input voltage range [V]	Output voltage AC [V]	Output current [V]	Active output power [W]	Appar. output power [VA]	Output peak current		Efficien. [%]	No load input current [A]
							5s [Arms]	(Iopk) 10ms [Apk]		
<b>ODS-1500-7111</b>	12	10.0 - 15	230	5.2	1200	1200	6.8	16	87	< 2.0
<b>ODS-1500-7113</b>	24	16.8 - 30	230	6.5	1500	1500	10	16	88	< 1.0
<b>ODS-1500-7114</b>	36	25.2 - 45	230	6.5	1500	1500	10	16	89	< 0.66
<b>ODS-1500-7115</b>	48	33.6 - 60	230	6.5	1500	1500	10	16	90	< 0.45
<b>ODS-1500-7116</b>	72	50.4 - 90	230	6.5	1500	1500	10	16	90	< 0.34
<b>ODS-1500-7117</b>	110	77 - 138	230	6.5	1500	1500	10	16	91	< 0.21
<b>ODS-1500-7121</b>	12	10.0 - 15	120	10.0	1200	1200	13	30	86	< 1.5
<b>ODS-1500-7123</b>	24	16.8 - 30	120	12.5	1500	1500	20	30	88	< 0.80
<b>ODS-1500-7124</b>	36	25.2 - 45	120	12.5	1500	1500	20	30	88	< 0.51
<b>ODS-1500-7125</b>	48	33.6 - 60	120	12.5	1500	1500	20	30	89	< 0.35
<b>ODS-1500-7126</b>	72	50.4 - 90	120	12.5	1500	1500	20	30	89	< 0.28
<b>ODS-1500-7127</b>	110	77 - 138	120	12.5	1500	1500	20	30	90	< 0.16

\*References subject to special MOQs and lead times

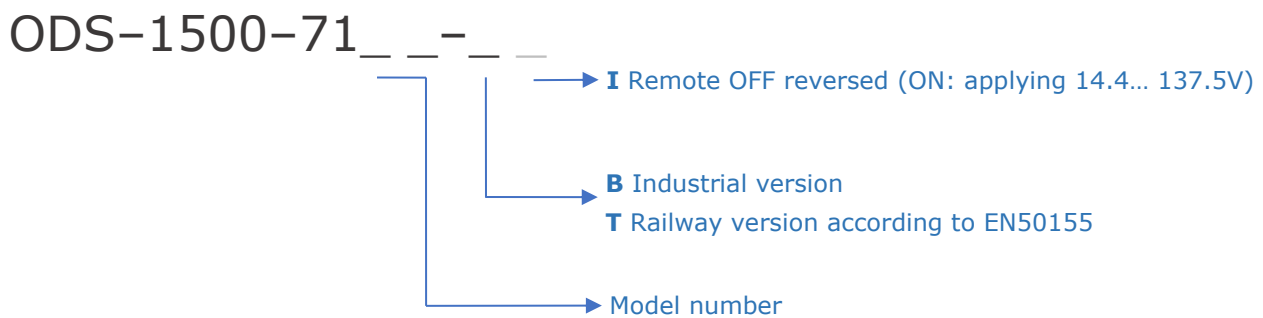

Accessories must be ordered in a separated order line

Note: Grounding bolt implemented recently. Please check with manufacturer to confirm availability of model



## BLOCKS DIAGRAM

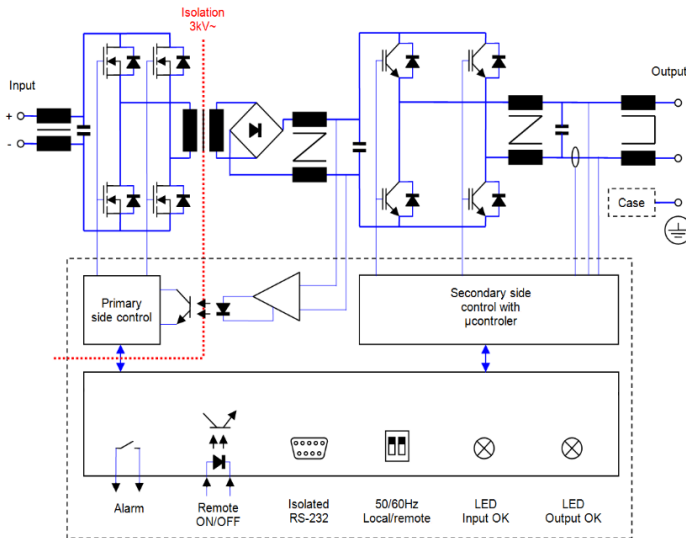

## CONNECTIONS

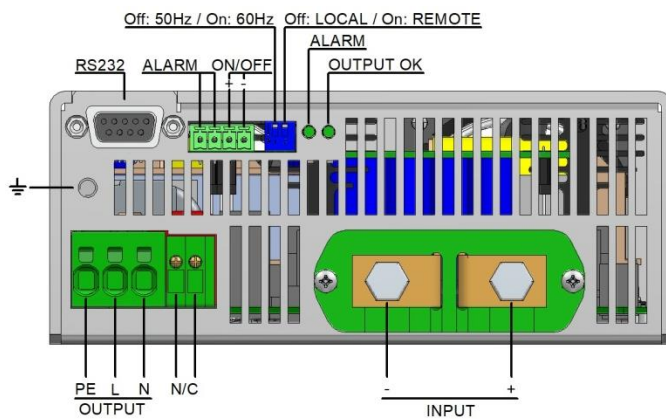

Input	Terminals M6 (Rec. torque 6 Nm)
Output	Cable up to 4 mm <sup>2</sup>
Earth	Bolt M5 (Rec. torque 3.8 Nm)
Alarm ON/OFF	Phoenix Contact MC1.5/4-G-3.81 (See accessories)
RS232	DB9
N/C	Do not use

## POWER DERATING vs AMBIENT TEMPERATURE

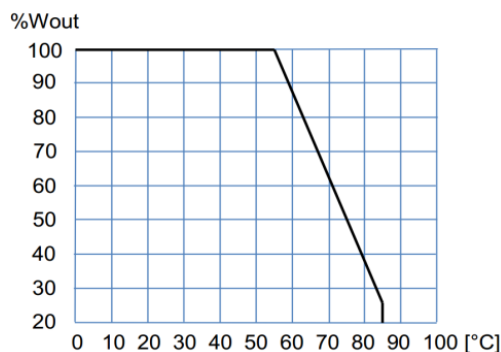

## DESCRIPTION

The ODS-1500 consists of single phase sine-wave DC/AC inverters with galvanic isolation between input and output

The unit allows:

- Select 50 / 60Hz by means of DIP-switch.
- Select local / remote (RS-232) by means of DIP-switch
- Shutdown applying voltage on pins 3 and 4 of signal connector
- Local signalization of Output OK by means of green LED
- Local alarm. Red LED ON when:
  - Output voltage is not OK
  - Output current > OUTPUT CURRENT ALARM
  - Input voltage out of margins
  - Unit shutdowns by over-current or remote OFF
- Alarm. Open contacts when output voltage is not OK
- Set and monitor parameters via RS-232.

The ODS-1500 are equipped with a maximum average power protection as well as maximum output peak current protection. This protects the unit even when an output short-circuit occurs. It also features a disable function for input under-voltage, which allows protecting the batteries from harmful discharges.

## INSTALLATION

- The unit has 6 threaded holes for the fixation on a mounting surface.
- The unit has internal fans. For an appropriate cooling, the air input and output should be free of elements that cause and an air flow reduction (minimum recommended distance to other objects 50mm).
- Make connections as shown in the figure.
- The default output frequency is 50Hz. For 60Hz simply actuate the dip-switch as indicated in the figure.

**For safety reasons, the following requirements must be met:**

- Provide the equipment with some kind of protective enclosure that complies with the electrical safety directives in effect within the country where the equipment is installed.
- Include an input fuse with a rating immediately higher than the maximum input current.
- Use cables of adequate cross-section to connect inputs and outputs. The following table lists the maximum currents and the minimum cross-sections for the cables used for each power connection.

	Input 12V	Input 24V	Input 36V	Input 48V	Input 72V	Input 110V	Output 120V	Output 230V
Max. current	140 A	100 A	75A	50 A	33 A	22 A	13 A	6.7 A
Cable cross-section	<b>35 mm<sup>2</sup></b>	<b>16 mm<sup>2</sup></b>	<b>16 mm<sup>2</sup></b>	<b>10 mm<sup>2</sup></b>	<b>6 mm<sup>2</sup></b>	<b>2.5 mm<sup>2</sup></b>	<b>1.5 mm<sup>2</sup></b>	<b>1.0 mm<sup>2</sup></b>

RS232 Functions	Monitor	Set
	Input voltage	Input under-voltage lockout
	Output voltage	Input under-voltage alarm
	Output current	ON / OFF
	Internal temperature	Output frequency
	Output frequency	Maximum output current
	Output power	Output voltage

## RS232 communication port

It is possible to control and monitor de unit via RS232 by means a terminal emulator like "Tera Term" or "Putty"

Also it is possible to control and monitor de unit directly using the protocol showed in table:



A null modem F-M is required

**Protocol configuration:** ASCII code, 19200 bauds, parity none, 8 bits, 1bit stop

Header	Function	Parameter	Returns	Explanation	
P	L	V	PTV####.#	Input voltage in Volts	
		U	PTU####.#	Output voltage in Volts RMS	
		I	PTI####.#	Output current in Amps RMS	
		T	PTT####.#	Internal temperature in °C	
		F	PTF####.#	Output frequency in Hz	
		W	PTW####.#	Output power in W	
		S	PTS####.#	Inverter state <b>999.9</b> → Inverter enabled <b>000.0</b> → Inverter disabled <b>222.2</b> → Inverter blocked by overload <b>111.1</b> → Inverter blocked by overload or short-circuit	
		M	PTM####.#	Model number	
		R	PTR####.#	Firmware version	
		Other character	PTE	Command not supported	
	R	1	####.#	OK	Set the minimum input working voltage in Volts
				ERR	Value NO VALID for this parameter
		2	####.#	OK	Set the minimum alarm input voltage in Volts (it should be higher than PRG1)
				ERR	Value NO VALID for this parameter
		3	####.#	OK	Changes the status bit (after start-up enabled with SW3 =LOCAL and disabled with SW3 =REMOTE) <b>999.9</b> → Inverter enabled <b>000.0</b> → Inverter disabled
				ERR	Value NO VALID for this parameter
		4	####.#	OK	Set the output voltage in Volts RMS $80\% V_{nom} \leq \text{####.#} \leq 105\% V_{nom}$
				ERR	Value NO VALID for this parameter
		5	####.#	OK	Set the maximum output current in Amps $20\% I_{nom} \leq \text{####.#} \leq 100\% I_{nom}$
				ERR	Value NO VALID for this parameter
6	####.#	OK	Changes the output frequency (it's not stored for the next start-up) <b>050.0</b> → 50Hz <b>060.0</b> → 60Hz		
		ERR	Value NO VALID for this parameter		
7	####.#	OK	Set the OUTPUT CURRENT ALARM $0 \leq \text{####.#} \leq 100\% I_{max\_warning}$		
		ERR	Value NO VALID for this parameter		
8	####.#	OK	<b>111.1</b> → Reset the inverter		
		ERR	Value NO VALID for this parameter		
A	####.#	OR	Set the start-up voltage in volts (it should be higher than PRG1)		
		ERR	Value NO VALID for this parameter		



## WORKING PARAMETERS

Thermal protection	71XX						
Internal warning temperature	88						°C
Internal shutdown temperature	92						°C
Internal restart temperature after over-temperature shutdown	75						°C
Input voltage parameters	71X1	71X3	71X4	71X5	71X6	71X7	
Max. input voltage shutdown instantaneous	16.8	33.7	50.6	67.3	100.9	154.1	Vdc
Max. input voltage shutdown timed 0.1s	15.1	30.1	45.2	60.1	90.1	138.6	Vdc
Maximum star-up voltage	14.9	29.9	44.9	59.8	89.7	137.4	Vdc
Minimum star-up voltage	10.6	17.9	26.9	35.9	53.9	82.4	Vdc
Min. input voltage shutdown timed 0.1s	10.0	16.7	25.1	33.5	50.3	76.9	Vdc
Min. input voltage shutdown instantaneous	9.6	14.4	21.6	28.7	43.1	65.9	Vdc
Output voltage parameters	711X			712X			
Output voltage of short circuit or deep overload	< 164			< 86			Vac
Time of short-circuit	1000						ms
Time of start-up after shutdown by short-circuit	2000						ms
Number of start-up attempts after short circuit	3						
Output current parameters	7111	7113/4/5/6/7	7121	7123/4/5/6/7			
Maximum continuous output current	5.3	6.6	10.1	12.7			A
Warning current	5.2	6.5	10	12.5			A
Start-up time after shutdown by overload	1000	1500	1000	2000			ms
Maximum overload I <sup>2</sup> t	See figure below						
Number of attempts of consecutive overload	3						
Start-up and working errors	71XX						
Maximum time for overload or internal failure	unlimited						
Minimum time required between disconnection and next connection	2						min

## OVERLOAD PROTECTION

Protection against overloads and short-circuits	By <b>current</b> limiting at I <sub>opk</sub> By <b>I<sup>2</sup>t</b> . The unit shutdowns when the current-time is over the continuous operation curve	
Overload protection recovery	Every 2 seconds after shutdown, the unit tries to restart up to 3 times. If the overload persists, the unit reminds shutdown until an <b>input reconnection</b> .	



## DIMENSIONS

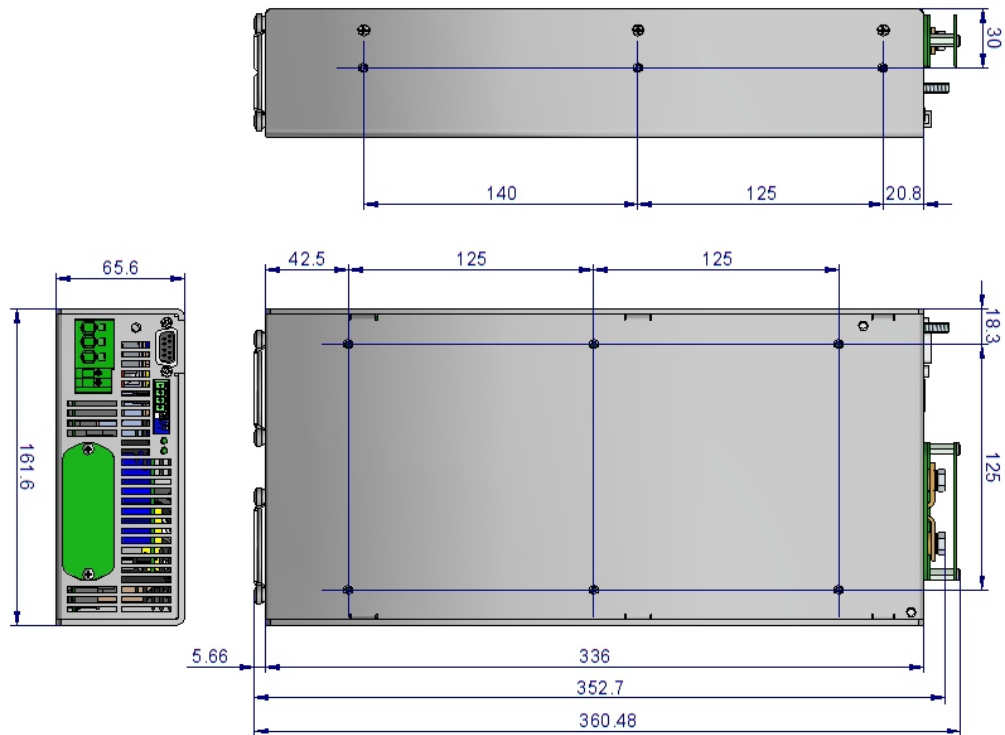

Fixing screws of the base: 6 x M4, maximum penetration depth 3.5mm

## ACCESSORIES

DESCRIPTION	NOTES	CODE
Mounting brackets kit	Contains two brackets and screws	NP-9282
DIN rail assembly kit	Screws included	NP-9339
2U 19" rack mounting tray kit	It allows to install one or two units	NP-9353
Signals female connector	Phoenix contact MC1.5/4-ST-3.81	2601-409

NP-9282

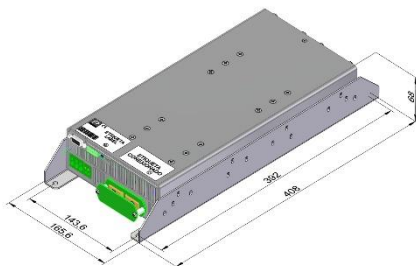

NP-9339

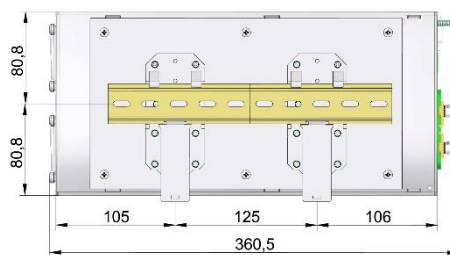

NP-9353

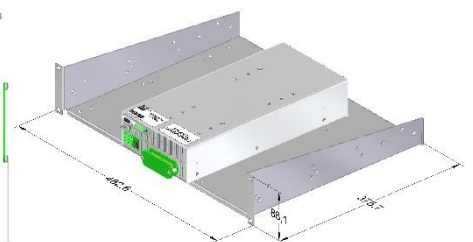

2601-409

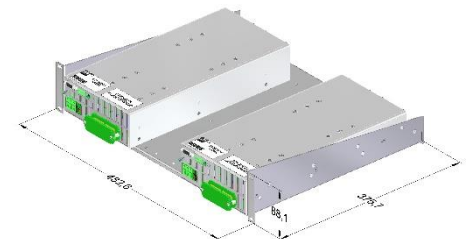
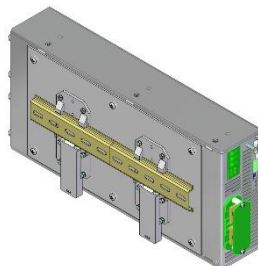

## EU, UKCA DECLARATION OF CONFORMITY



The undersigned, representing the following:

Manufacturer: PREMIUM, S. A.,  
Address: C/ Dolors Aleu 19-21, 08908 L'Hospitalet de Llobregat, SPAIN

herewith declares that the product:

Type: DC/DC converter  
Models: **ODS-1500-7111 ... 7127**

is in conformity with the provisions of the following EU directive(s):

2014/35/EU SI 2016 No 1101	Low voltage / The electrical equipment (safety) regulations
2014/30/EU SI 2016 No 1091	EMC / Electromagnetic compatibility regulations
2015/863/EU SI 2012 No. 3032	RoHS / Restriction of the use of certain hazardous substances in electrical and electronic equipment

and that standards and/or technical specifications referenced below have been applied:

EN 60950-1: 2005	Safety. Information technology equipment
EN 62368-1: 2014	Safety. Audio/video, information and communication technology equipment
EN 61000-6-3: 2007	Generic emission standard
EN 61000-6-2: 2005	Generic immunity standard
EN 50155: 2017*	Railway applications. Electronic equipment used on rolling stock material
EN 50121-3-2: 2016*	Railway applications. EMC Rolling stock equipment

\* Optional, See annexe

CE marking year: **2010**; UKCA marking year: **2021**

Notes:

For the fulfilment of this declaration the product must be used only for the aim that has been conceived, considering the limitations established in the instructions manual or datasheet.

L'Hospitalet de Llobregat, 31-05-2021

Albert Sole  
Technical Director

**PREMIUM S.A.** is an ISO9001 and ISO14001  
certified company by **Bureau Veritas**



**ANNEXE**

Applicable values for the different sections of the norm EN50155: 2017																																																																		
4.3.1	Working altitude	Up to 2000m																																																																
4.3.2	Ambient temperature	Class OT1 (-25 to 55°C): load < 100% Class OT2 (-40 to 55°C): load < 100% (Without connectors handling) Class OT3 (-25 to 70°C): load <75% Class OT4 (-40 to 70°C): load <75% (Without Connectors handling) Class OT5 (-25 to 85°C): load <37.5% Class OT6 (-40 to 85°C): load <37.5% (Without Connectors handling)																																																																
4.3.3	Switch-on extended operating temp.	ST1																																																																
4.3.4	Rapid temperature variations	H1																																																																
4.3.5	Shocks and vibrations	According EN61373:2010 Category 1 class B																																																																
4.3.6	EMC Electromagnetic Compatibility EN50121-3-2:2016	<table border="1"> <thead> <tr> <th>Test</th> <th>Norm</th> <th>Port</th> <th>Frequency</th> <th>Limits</th> </tr> </thead> <tbody> <tr> <td rowspan="3">Radiated emissions</td> <td rowspan="3">IEC55016</td> <td rowspan="3">Case</td> <td>30MHz...230MHz</td> <td>40dB(µV/m) Qpk at 10m</td> </tr> <tr> <td>230MHz...1GHz</td> <td>47dB(µV/m) Qpk at 10m</td> </tr> <tr> <td>1...3GHz</td> <td>Do not apply</td> </tr> <tr> <td rowspan="2">Conducted emissions</td> <td rowspan="2">IEC55016</td> <td rowspan="2">Input</td> <td>3...6GHz</td> <td>Internal freq. &lt; 108MHz</td> </tr> <tr> <td>150kHz...500kHz</td> <td>99dB(µV) Qpk</td> </tr> <tr> <td></td> <td></td> <td></td> <td>500kHz...30MHz</td> <td>93dB(µV) Qpk</td> </tr> </tbody> </table>	Test	Norm	Port	Frequency	Limits	Radiated emissions	IEC55016	Case	30MHz...230MHz	40dB(µV/m) Qpk at 10m	230MHz...1GHz	47dB(µV/m) Qpk at 10m	1...3GHz	Do not apply	Conducted emissions	IEC55016	Input	3...6GHz	Internal freq. < 108MHz	150kHz...500kHz	99dB(µV) Qpk				500kHz...30MHz	93dB(µV) Qpk																																						
		Test	Norm	Port	Frequency	Limits																																																												
		Radiated emissions	IEC55016	Case	30MHz...230MHz	40dB(µV/m) Qpk at 10m																																																												
					230MHz...1GHz	47dB(µV/m) Qpk at 10m																																																												
					1...3GHz	Do not apply																																																												
		Conducted emissions	IEC55016	Input	3...6GHz	Internal freq. < 108MHz																																																												
					150kHz...500kHz	99dB(µV) Qpk																																																												
					500kHz...30MHz	93dB(µV) Qpk																																																												
		<table border="1"> <thead> <tr> <th>Test</th> <th>Norm</th> <th>Port</th> <th>Severity</th> <th>Conditions</th> <th>P</th> </tr> </thead> <tbody> <tr> <td rowspan="2">Electrostatic discharge</td> <td rowspan="2">IEC61000-4-2</td> <td rowspan="2">Case</td> <td>±8kV</td> <td>Air (isolated parts)</td> <td rowspan="2">B</td> </tr> <tr> <td>±8kV</td> <td>Contact (conductive parts)</td> </tr> <tr> <td rowspan="4">Radiated high-frequency</td> <td rowspan="4">IEC61000-4-3</td> <td rowspan="4">X/Y/Z Axis</td> <td>20V/m</td> <td>0.08...1.0GHz M. 80% 1kHz</td> <td rowspan="4">A</td> </tr> <tr> <td>10V/m</td> <td>1.4...2.1GHz M. 80% 1kHz</td> </tr> <tr> <td>5V/m</td> <td>2.1...2.5GHz M. 80% 1kHz</td> </tr> <tr> <td>3V/m</td> <td>5.1...6Ghz M. 80% 1kHz</td> </tr> <tr> <td rowspan="4">Fast transients</td> <td rowspan="4">IEC61000-4-4</td> <td>Input</td> <td>±2kV</td> <td rowspan="4">Tr/Th: 5/50 ns</td> <td rowspan="4">A</td> </tr> <tr> <td>Output</td> <td>±2kV</td> </tr> <tr> <td>Signal</td> <td>±2kV</td> </tr> <tr> <td>PE</td> <td>±1kV</td> </tr> <tr> <td rowspan="2">Surge</td> <td rowspan="2">IEC61000-4-5</td> <td>Input L to L</td> <td>±1kV</td> <td rowspan="2">Tr/Th: 1.2/50µs</td> <td rowspan="2">B</td> </tr> <tr> <td>Input L to PE</td> <td>±2kV</td> </tr> <tr> <td rowspan="4">Conducted RF</td> <td rowspan="4">IEC61000-4-6</td> <td>Input</td> <td>10V</td> <td rowspan="4">0.15...80MHz M. 80% 1kHz</td> <td rowspan="4">A</td> </tr> <tr> <td>Output</td> <td>10V</td> </tr> <tr> <td>Signal</td> <td>10V</td> </tr> <tr> <td>PE</td> <td>10V</td> </tr> <tr> <td>Magnetic field</td> <td>IEC61000-4-8</td> <td>X/Y/Z Axis</td> <td>300A/m</td> <td>0Hz, 16.7Hz, 50/60Hz</td> <td>A</td> </tr> </tbody> </table>	Test	Norm	Port	Severity	Conditions	P	Electrostatic discharge	IEC61000-4-2	Case	±8kV	Air (isolated parts)	B	±8kV	Contact (conductive parts)	Radiated high-frequency	IEC61000-4-3	X/Y/Z Axis	20V/m	0.08...1.0GHz M. 80% 1kHz	A	10V/m	1.4...2.1GHz M. 80% 1kHz	5V/m	2.1...2.5GHz M. 80% 1kHz	3V/m	5.1...6Ghz M. 80% 1kHz	Fast transients	IEC61000-4-4	Input	±2kV	Tr/Th: 5/50 ns	A	Output	±2kV	Signal	±2kV	PE	±1kV	Surge	IEC61000-4-5	Input L to L	±1kV	Tr/Th: 1.2/50µs	B	Input L to PE	±2kV	Conducted RF	IEC61000-4-6	Input	10V	0.15...80MHz M. 80% 1kHz	A	Output	10V	Signal	10V	PE	10V	Magnetic field	IEC61000-4-8	X/Y/Z Axis	300A/m	0Hz, 16.7Hz, 50/60Hz	A
		Test	Norm	Port	Severity	Conditions	P																																																											
		Electrostatic discharge	IEC61000-4-2	Case	±8kV	Air (isolated parts)	B																																																											
					±8kV	Contact (conductive parts)																																																												
		Radiated high-frequency	IEC61000-4-3	X/Y/Z Axis	20V/m	0.08...1.0GHz M. 80% 1kHz	A																																																											
					10V/m	1.4...2.1GHz M. 80% 1kHz																																																												
5V/m	2.1...2.5GHz M. 80% 1kHz																																																																	
3V/m	5.1...6Ghz M. 80% 1kHz																																																																	
Fast transients	IEC61000-4-4	Input	±2kV	Tr/Th: 5/50 ns	A																																																													
		Output	±2kV																																																															
		Signal	±2kV																																																															
		PE	±1kV																																																															
Surge	IEC61000-4-5	Input L to L	±1kV	Tr/Th: 1.2/50µs	B																																																													
		Input L to PE	±2kV																																																															
Conducted RF	IEC61000-4-6	Input	10V	0.15...80MHz M. 80% 1kHz	A																																																													
		Output	10V																																																															
		Signal	10V																																																															
		PE	10V																																																															
Magnetic field	IEC61000-4-8	X/Y/Z Axis	300A/m	0Hz, 16.7Hz, 50/60Hz	A																																																													
<b>P=</b> Performance criteria, L= Line, PE= Protective Earth																																																																		
4.3.7	Relative humidity	Up to 95%																																																																
5.1.1.2	DC power supply range	From 0.70 to 1.25 Un continuous																																																																
5.1.1.3	Temporary DC power supply fluctuation	From 0.60 to 1.40 Un 0.1s From 1.25 to 1.40 Un 1s without damage																																																																
5.1.1.4	Interruptions of voltage supply	Class S1 (without interruptions)																																																																
5.1.1.6	Input ripple factor	10% peak to peak with a DC Ripple Factor of 5 %																																																																
5.1.3	Supply change-over	0.6 Un duration 100 ms (without interruptions). Performance criterion A																																																																
7.2.7	Input reverse polarity protection	By external fuse																																																																
10.7	Protective coating for PCB assemblies	Class PC2																																																																
13.3	Tests list	<table border="0"> <tr> <td>1 Visual Inspection</td> <td>Routine</td> </tr> <tr> <td>2 Performance test</td> <td>Routine</td> </tr> <tr> <td>3 Power supply test</td> <td>Routine</td> </tr> <tr> <td>4 Insulation test</td> <td>Routine</td> </tr> <tr> <td>5 Low temperature storage test</td> <td>-</td> </tr> <tr> <td>6 Low temperature start-up test</td> <td>Type</td> </tr> <tr> <td>7 Dry heat test</td> <td>Type</td> </tr> <tr> <td>8 Cyclic damp heat test</td> <td>Type</td> </tr> <tr> <td>9 Salt mist test</td> <td>-</td> </tr> <tr> <td>10 Enclosure protection test (IP code)</td> <td>-</td> </tr> <tr> <td>11 EMC test</td> <td>Type</td> </tr> <tr> <td>12 Shocks and vibrations test</td> <td>Type</td> </tr> <tr> <td>13 Equipment stress screening test</td> <td>Routine: 24h at 40°C and load 100%</td> </tr> <tr> <td>14 Rapid Temperature variation test</td> <td>Type</td> </tr> </table>	1 Visual Inspection	Routine	2 Performance test	Routine	3 Power supply test	Routine	4 Insulation test	Routine	5 Low temperature storage test	-	6 Low temperature start-up test	Type	7 Dry heat test	Type	8 Cyclic damp heat test	Type	9 Salt mist test	-	10 Enclosure protection test (IP code)	-	11 EMC test	Type	12 Shocks and vibrations test	Type	13 Equipment stress screening test	Routine: 24h at 40°C and load 100%	14 Rapid Temperature variation test	Type																																				
1 Visual Inspection	Routine																																																																	
2 Performance test	Routine																																																																	
3 Power supply test	Routine																																																																	
4 Insulation test	Routine																																																																	
5 Low temperature storage test	-																																																																	
6 Low temperature start-up test	Type																																																																	
7 Dry heat test	Type																																																																	
8 Cyclic damp heat test	Type																																																																	
9 Salt mist test	-																																																																	
10 Enclosure protection test (IP code)	-																																																																	
11 EMC test	Type																																																																	
12 Shocks and vibrations test	Type																																																																	
13 Equipment stress screening test	Routine: 24h at 40°C and load 100%																																																																	
14 Rapid Temperature variation test	Type																																																																	