

DATA SHEET

SSIM-101, 102, 103, 104 (kit)

SELF-START IMPEDANCE MATCHING (SSIM) POWER CONVERTER

1. FEATURES

- Verified 72% of maximum circuit efficiency with various commercial piezoelectric energy harvesters (Input current: 120 μ A).
- Wide input voltage ranges for high impedance source, input voltage range = 2V to 40V
- Low cold-start voltage: 1.5V
- Built-in passive controller for switching between standby and active mode of power converter to save the power.
- Selectable impedance matching ranges to maximize the efficiency (SSIM-101-L, SSIM-101-M, SSIM-101-H)
- Selectable output voltage: 1.8V, 2.5V, 3.3V

2. APPLICATIONS

- Piezoelectric cantilevers
- Piezoelectric multilayered stacks
- Vibrational energy harvesting
- Impact force energy harvesting
- Acoustic underwater energy harvesting

3. DESCRIPTION

The SSIM-100 is self-start impedance matching with ultralow quiescent current power supply designed specifically for energy harvesting. Intermittent or continuous energy input from the vibration energy harvesting device stores their associated energy in battery or supercapacitor. Notably, the self-start functionality can start operation even when a battery or a supercapacitor is fully discharged. To save power, the circuit monitors the onset of vibration or impact excitation to automatically switch between sleep and active modes.

The self-start impedance matching circuit has a full-wave bridge rectifier for AC to DC conversion, a buck-boost converter for impedance matching, impedance matching controller for controlling buck-boost converter to control the impedance matching value, a self-start controller for power

saving. SSIM-101 regulates storage device voltage for stable voltage supply with selectable voltages (1.8 V, 2.5 V, 3.3 V).

4. APPEARANCE



Size of board: 0.59 (W) \times 0.95 (L) inches

5. PHYSICAL DIMENSION

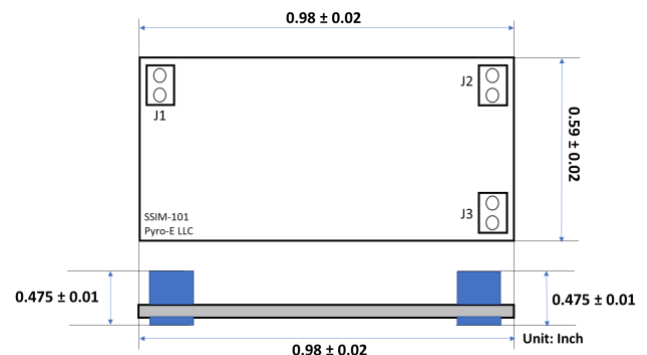



Life Tag

Unplan Obsolescence

A Pyro-E company

6. PIN CONFIGURATION

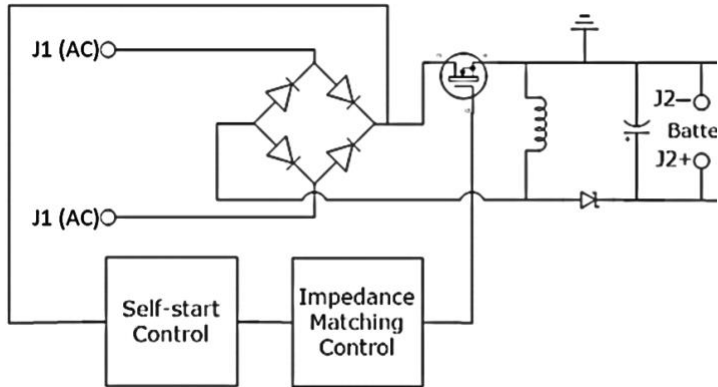

7. PIN FUNCTIONS

| Pins | Description |
|------|---|
| J1 | Input Connection for piezoelectric energy harvester or other AC source. |
| J2 | Storage device output with battery protection (Red: +, Black: -) |
| J3 | Selectable output load based on SW1 and SW2 (1.8 V, 2.5V, or 3.3V), Default: 3.3V |
| SW1 | Connect two pads to set output voltage J3 to 2.5 V |
| SW2 | Connect two pads to set output voltage J3 to 1.8 V (SW1 also connect) |

8. SPECIFICATION

7.1 ABSOLUTE MAXIMUM RATINGS

Absolute Maximum Ratings

| | |
|--------------------------------|--|
| Input Voltage: 40 V | Impedance Matching Value: 200 kΩ |
| Input Current: 60 mA | |

8.2 ELECTRICAL CHARACTERISTICS

| Parameter | Min | Typ | Max | Unit |
|-----------------------|-----|-----|-----|------|
| Input Voltage | 2 | | 40 | V |
| Input Current | 0 | | 60 | mA |
| Output Current | 0 | | 50 | mA |
| Output Power | 0 | | 210 | mW |

| | | | | | |
|---|--------------|-----|-----|-----|-----|
| Impedance Matching Ranges | 101-L | 0.1 | 3 | 10 | kΩ |
| | 101-M | 10 | 30 | 60 | kΩ |
| | 101-H | 50 | 100 | 150 | kΩ |
| Switching Frequency | | 2 | | 6 | kHz |
| Start-up time (Input Voltage = 2V) | | 9 | 10 | 11 | ms |

9. TYPICAL PERFORMANCE

8.1 START UP RESPONSE

The self-start functionality can start circuit operation even when a battery or a supercapacitor is fully discharged. Fig. 1 shows the self-starting performance of self-start controller. When the start-up voltage becomes nonzero and starts to increase (upper line), the PWM generated by impedance matching controller is activated in 10 ms (bottom line).

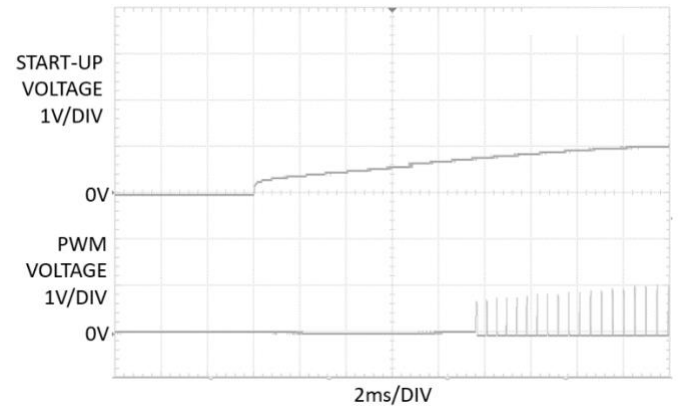

Figure 1. Start-up response of self-start controller

9.2 EFFICIENCY

SSIM-101 has L (3kΩ), M (30kΩ), H (100kΩ) models based on the impedance matching values. Fig. 2 shows the efficiency vs input voltage and power with three impedance matching values. efficiency is defined as

$$\text{Efficiency} = \frac{\text{Charging power to battery}}{\text{Maximum power generated by energy harvester}}$$

As input voltage increases, efficiency increases. Maximum efficiency, 72 % is appeared after 5 V of input voltage.

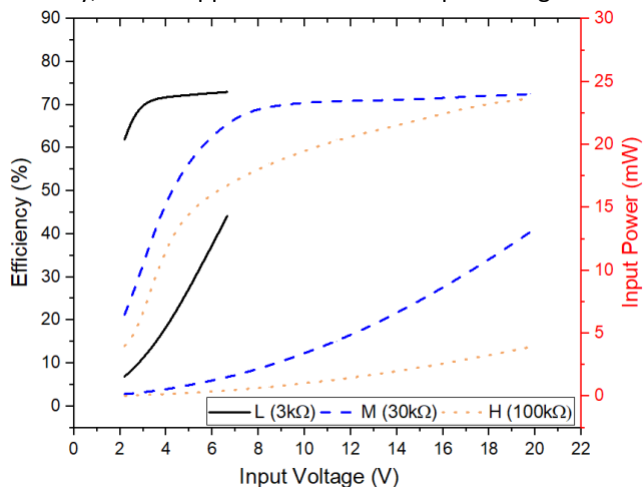

Figure 2. Efficiency vs. Input Voltage / Power

Fig. 3 show efficiency vs source impedance with 1.5 and 3 mW of input power generated by energy harvester. With ranges of 100Ω to 10kΩ, L model shows 40-72% of efficiency, 42-70% with ranges of 10kΩ to 60kΩ (M model), and 42-69% with 50kΩ to 150kΩ (H model). As input power increases, efficiency of SSIM-101 also increases.

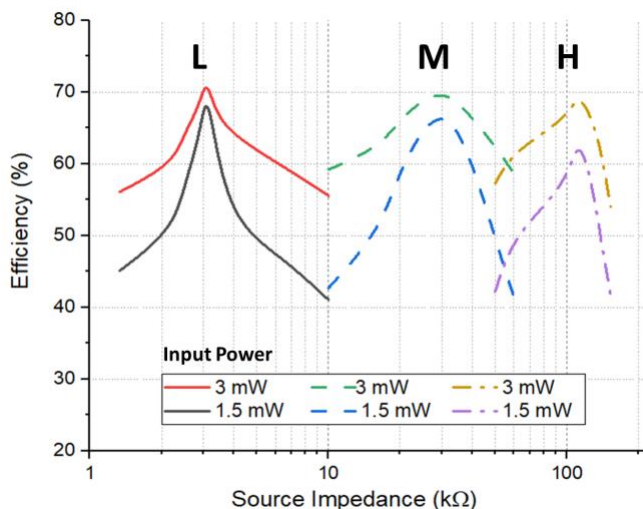

Figure 3. Efficiency vs Source impedance/ Power

10. TECHNICAL DISCRPTION

SSIM-101 has a DC-DC converter for impedance matching. The impedance of harvester must match the load impedance to maximize power transfer to the load, namely impedance matching. However, electrical loads (such as a battery) typically have 10-1000 times lower impedance than a piezoelectric harvester. Thus, the charging efficiency without impedance matching circuit is extremely low. Input impedance of buck-boost converter can be emulated to match the impedance with harvester using PWM (pulse width modulation) control. Depend on the switching frequency and duty cycle of PWM, the input impedance of DC-DC converter can be tuned to match that of the harvester.

SSIM-101 can be integrated with wireless sensor node, which consists of microcontroller, wireless transmitter, and sensors. Fig.4 shows first configuration of wireless sensor node with SSIM-101. J2 is output of impedance matching circuit and can be connected with storage device. Built-in linear regulator (LDO) regulates the voltage, and microcontroller, wireless transmitter and sensor can be connected with J3. J3 is selectable output (1.8V, 2.5V, 3.3V) pin and can be selected based on supply voltage of wireless sensor node.

A second configuration of wireless sensor node with SSIM-101 is shown in Fig. 5. When LDO is integrated in user's wireless sensor node, J2 is connected with storage device of wireless sensor node without connection of J3.

11. APPLICATION

WIRELESS SENSOR NODE

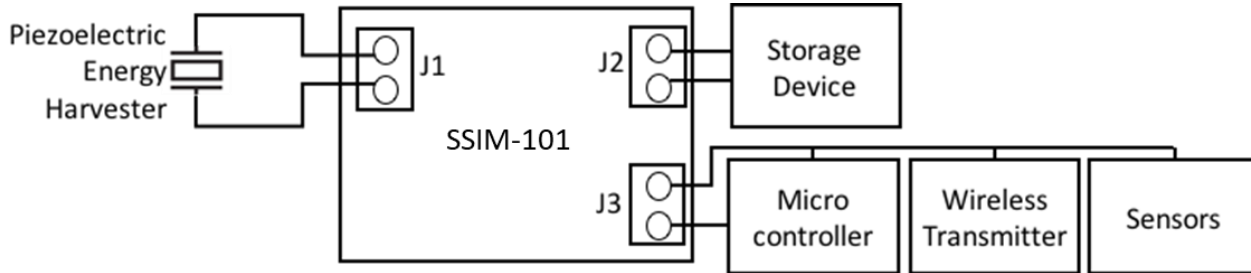

Figure 4. Example 1: Wireless sensor node with SSIM-101

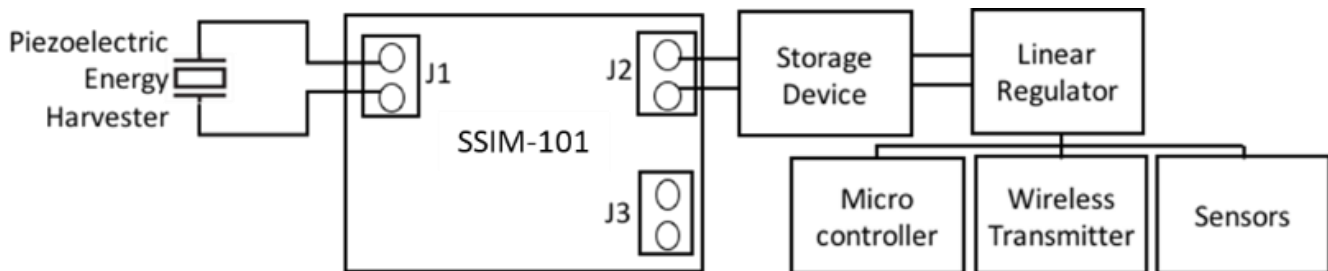

Figure 5. Example 2: Wireless sensor node with SSIM-101

12. ORDER INFORMATION

| Product | Impedance Matching Ranges | Size | Comment |
|----------|---------------------------------|---|---------------|
| SSIM-100 | 1.4 k Ω - 200 k Ω | 2.50 (W) \times 2.50 (L) \times 0.53 (H) inches | EVAL (3 PCBs) |
| SSIM-101 | 100 Ω - 10 k Ω | 0.59 (W) \times 0.98 (L) \times 0.47 (H) inches | DIY (3 PCBs) |
| SSIM-102 | 10 k Ω - 60 k Ω | 0.59 (W) \times 0.98 (L) \times 0.47 (H) inches | DIY (3 PCBs) |
| SSIM-103 | 50 k Ω - 150 k Ω | 0.59 (W) \times 0.98 (L) \times 0.47 (H) inches | DIY (3 PCBs) |
| SSIM-104 | 100 Ω - 150 k Ω | 0.59 (W) \times 0.98 (L) \times 0.47 (H) inches | KIT (3 PCBs) |



Technical Engineer
 Phone: (510) 578-8849
 Email: info@pyro-e.com
 Address: 2079 E 15th St Ste 127,
 Los Angeles, CA 90021