

HAT901 SERIES

POWER RELAY



File No.:E75887



File No.:R 50194653

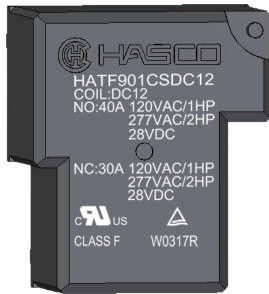

FEATURES

- 4kV Type: 4000VAC high dielectric strength (between contacts and coil)
- Max. switch capacity up to 40A
- Wide contact gap available

CONTACT RATINGS

Contact Arrangement	1A, 1B, 1C
Contact Resistance	≤50mΩ (1A 24VDC)
Contact Material	30A(Non-Cd only), 40A(Cd, Non-Cd)
Contact Rating(Resistive)	30/40A 277VAC, 30A/28VDC
Max. Switching Voltage	277VAC/28VDC
Max. Switching Current	40A
Max. Switching Power	11080VA/840W
Mechanical Life	1×10 ⁷ operations
Electrical Life	See more details at "safety approval ratings"

CHARACTERISTICS

Insulation Resistance	1000MΩ (at 500VDC)	
Dielectric Strength	Between coil & contacts	2000/2500/4000VAC 1min
	Between open contacts	1500VAC 1min
Operate time (at nomi. volt.)	≤15ms	
Release time (at nomi. volt.)	≤10ms	
Humidity	98% RH	
Operation temperature	DC:-55°C~+85°C; AC:-55°C~+60°C	
UL Class B/F/H	Insulation System Class B/F/H	
Shock Resistance	Functional	98m/s ²
	Destructive	980m/s ²
Vibration resistance	10Hz to 55Hz 1.5mm DA	
Unit weight	Approx. 25g	
Construction	Sealed Type, Dust Cover Type, Open Type, Flux Tight Type	

Notes:1) The data shown above are initial values.
2) Please find coil temperature curve in the characteristic curves.

ORDERING INFORMATION

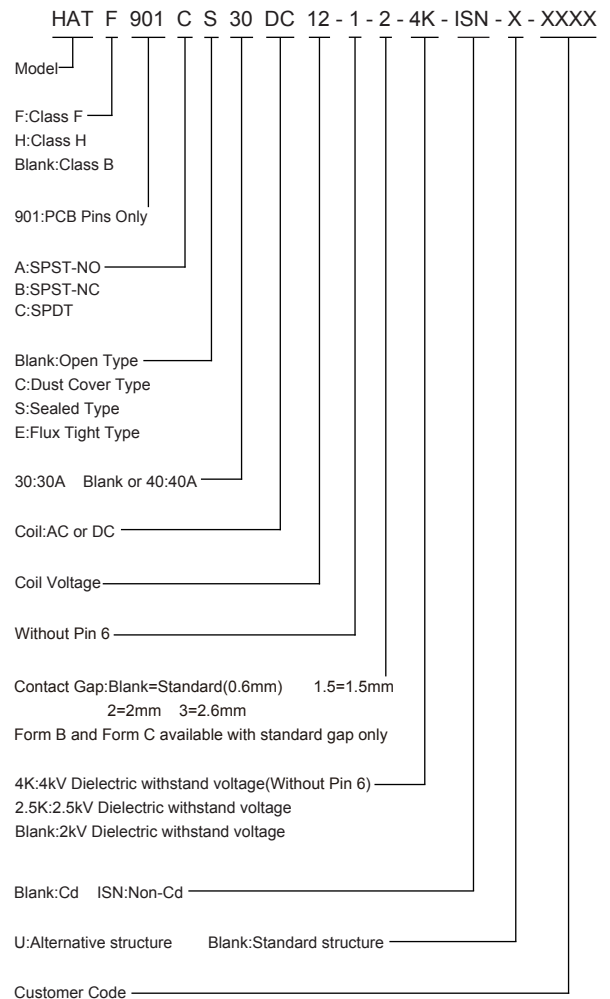

Notes:

1. PC board assembled with dust cover type and flux tight type relays can not be washed and/or coated.
2. Dust cover type and flux tight type relays can not be used in the environment with dust, or H₂S, SO₂, NO₂ or similar gaseous environment etc.

This datasheet is for customers' reference. All the specifications are subject to change without notice.



* SINCE 1976 *

TEL:(516) 328-9292 FAX:(516)326-9125 www.hascorelays.com email:info@hascorelays.com

RELAYS

COIL DATA

at 25°C

DC

Nominal Voltage VDC	Operate Voltage (Max.) VDC	Release Voltage (Min.) VDC	*Max. Allowable Voltage VDC	Coil Resistance $\Omega \pm 10\%$
5	3.75	0.50	6.50	27
6	4.50	0.60	7.80	40
9	6.75	0.90	11.70	97
12	9.00	1.20	15.60	155
15	11.25	1.50	19.50	256
18	13.50	1.80	23.40	380
22	16.50	2.20	28.60	640
24	18.00	2.40	31.20	660
48	36.00	4.80	62.40	2560
110	82.50	11.00	143.00	13400

AC

Nominal Voltage VAC	Operate Voltage (Max.) VAC	Release Voltage (Min.) VAC	*Max. Allowable Voltage VAC	Coil Resistance $\Omega \pm 10\%$
12	9.6	1.2	14.40	27
24	19.2	2.4	28.80	120
110	88.0	11.0	132.0	2360
120	96.0	12.0	144.0	3040
220	176.0	22.0	264.0	13490
240	192.0	24.0	288.0	15735
277	221.6	27.7	332.4	20300

Note: **Max Allowable Voltage**: The relay coil can endure max allowable voltage for a short period time only.

COIL

Coil Power	DC:Approx. 900mW AC:2VA
------------	-------------------------

This datasheet is for customers' reference. All the specifications are subject to change without notice.

SAFETY APPROVAL RATINGS

UL&CUL	Cd Contact (40A)	<p>N.O.:30A 28VDC; N.C.:30A/28VDC, 6×10³ OPS</p> <p>N.O.:10A 480VAC; N.C.:10A 480VAC, 6×10³ OPS</p> <p>N.O.:20A 240VAC, 25×10⁴ OPS</p> <p>N.O.:30A 277VAC; N.C.:30A 277VAC, G.P., 6×10³ OPS</p> <p>N.O.:40A 277VAC; N.C.:40A 277VAC, G.P., 6×10³ OPS</p> <p>N.O.:40A 305VAC, G.P., 6×10³ OPS</p> <p>N.C.:2A 480VAC, G.P., 6×10³ OPS</p> <p>N.O.:1HP 120VAC; N.C.:1HP 120VAC, 6×10³ OPS</p> <p>N.O.:2HP 277VAC; N.C.:2HP 277VAC, 6×10³ OPS</p> <p>N.O.:1HP 120/208VAC, 1×10⁵ OPS</p> <p>N.O.:10FLA, 30LRA, 240VAC;</p> <p>N.C.:10FLA, 30LRA, 240VAC, 6×10³ OPS</p> <p>N.C.:12FLA, 30LRA, 120VAC, 6×10³ OPS</p> <p>N.O.:30FLA, 90LRA, 120VAC, 1×10⁵ OPS</p> <p>N.C.:5FLA, 15LRA, 120VAC, 3×10⁴ OPS</p> <p>N.O.:8.8FLA, 52.8LRA, 240VAC, 1×10⁵ OPS</p> <p>N.O.:20FLA, 60LRA, 277VAC, 1×10⁵ OPS</p> <p>N.C.:20FLA, 60LRA, 277VAC, 1×10⁵ OPS</p> <p>N.O.:20A 277VAC; N.C.:20A 277VAC, Ballast, 1×10⁵ OPS</p> <p>N.O.:30A 120VAC Ballast, 6×10³ OPS</p> <p>N.C.:10A 277VAC Ballast, 6×10³ OPS</p> <p>N.O.:15A 120VAC Tungsten, 6×10³ OPS</p> <p>N.C.:2A 120VAC Tungsten, 6×10³ OPS</p> <p>N.O.:16A 277VAC, Electronic Ballast, 6×10⁴ OPS</p> <p>N.O.:TV8 277VAC</p> <p>N.O.:A300 Pilot Duty, 6×10³ OPS</p> <p>N.O.:277VAC, 1100 VA Pilot Duty, 6×10³ OPS</p>
	Non-Cd Contact (40A)	<p>N.O.:30A 28VDC; N.C.:30A 28VDC, 6×10³ OPS</p> <p>N.O.:40A 277VAC; N.C.:40A 277VAC, G.P., 6×10³ OPS</p> <p>N.O.:30A 28VDC, G.P., 40°C, 6×10³ OPS</p> <p>N.O.:40A 305VAC, G.P., -40°C to +40°C, 6×10³ OPS</p> <p>N.O.:1HP 120VAC; N.C.:1HP 120VAC, 6×10³ OPS</p> <p>N.O.:2HP 277VAC; N.C.:2HP 277VAC, 6×10³ OPS</p> <p>N.O.:20A 277VAC Ballast, 6×10³ OPS</p> <p>N.O.:30A 120VAC Ballast, 6×10³ OPS</p> <p>N.O.:10A 277VAC, Electronic Ballast, 55°C, 6×10³ OPS</p> <p>N.C.:10A 277VAC, Ballast, 6×10³ OPS</p> <p>N.O.:15A 120VAC Tungsten, 6×10³ OPS</p> <p>N.C.:5A 120VAC Tungsten, 6×10³ OPS</p> <p>N.O.:TV8 277VAC</p> <p>N.O.:240VAC 5500W, 80°C, 1×10⁵ OPS(HATF/H 901DC -U only, with vent hole opened)(pending)</p> <p>N.O.:208VAC 5500W, 80°C, 1×10⁵ OPS(HATF/H 901DC -U only, with vent hole opened)(pending)</p>
	Non-Cd Contact (30A)	<p>N.O.:30A 28VDC, 6×10³ OPS</p> <p>N.C.:20A 28VDC, 6×10³ OPS</p> <p>N.O.:30A 277VAC, G.P., 6×10³ OPS</p> <p>N.C.:20A 277VAC, G.P., 6×10³ OPS</p> <p>N.O.:1HP 120VAC, 6×10³ OPS</p> <p>N.C.:1HP 277VAC, 6×10³ OPS</p> <p>N.O.:2HP 277VAC, 6×10³ OPS</p> <p>N.C.:1/4HP 120VAC, 6×10³ OPS</p> <p>N.O.:20A 277VAC Ballast, 6×10³ OPS</p> <p>N.C.:10A 277VAC Ballast, 6×10³ OPS</p> <p>N.O.:15A 120VAC Tungsten, 6×10³ OPS</p> <p>N.C.:2A 120VAC Tungsten, 6×10³ OPS</p>

TüV	Cd Contact (40A)	<p>N.O.:40A 277VAC; N.C.:40A 277VAC, 1×10⁴ OPS</p> <p>N.O.:40A 28VDC; N.C.:40A 28VDC, 1×10⁴ OPS</p> <p>N.O./N.C.:40A(make)/30A(break) 277VAC, 8×10³ OPS</p> <p>N.O./N.C.:40A(make)/30A(break) 28VDC, 6×10³ OPS</p>
	Non-Cd Contact (40A)	<p>N.O.:40A 277VAC, 85°C, 1×10⁴ OPS</p> <p>N.O.:40A 277VAC, 5×10⁴ OPS</p> <p>N.C.:40A 277VAC, 1×10⁴ OPS</p> <p>N.O.:40A 28VDC; N.C.:40A 28VDC, 1×10⁴ OPS</p> <p>N.O./N.C.:40A(make)/30A(break) 277VAC, 1×10⁴ OPS</p> <p>N.O./N.C.:40A(make)/30A(break) 28VDC, 1×10⁴ OPS</p>
	Non-Cd Contact (30A)	<p>N.O./N.C.:20A(make)/15A(break) 240VAC, 1×10⁴ OPS</p> <p>N.O./N.C.:20A(make)/15A(break) 14VDC, 1×10⁴ OPS</p>

NOTES:

1. All values without specified temperature are at 25°C.
2. The above lists the typical loads only. Other loads may be available upon request.

This datasheet is for customers' reference. All the specifications are subject to change without notice.

HAT901 SERIES

POWER RELAY

OUTLINE DIMENSIONS, WIRING DIAGRAM AND PC BOARD LAYOUT.

Unit: inch(mm)

Outline Dimensions

Wiring Diagram (Bottom view)

PCB Layout (Bottom view)

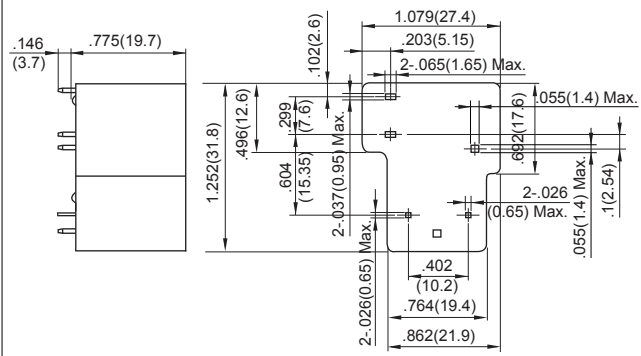
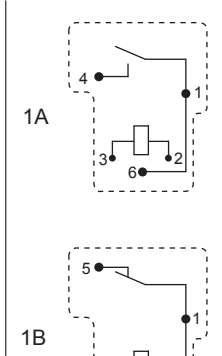
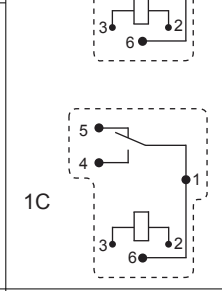
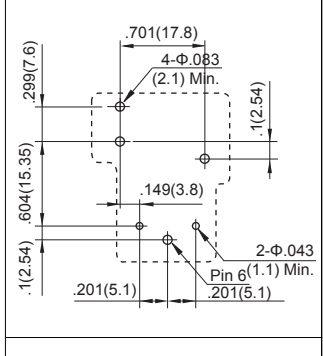
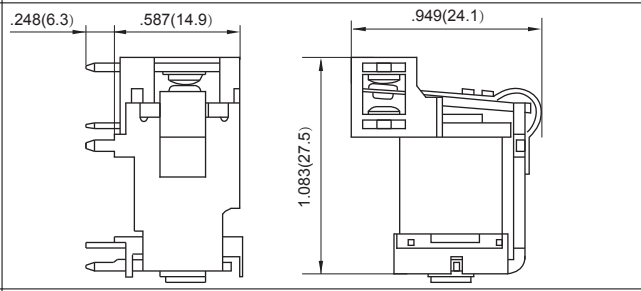
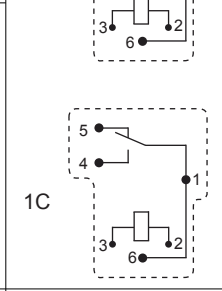
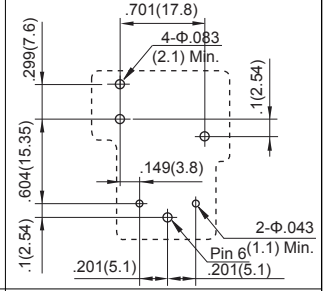
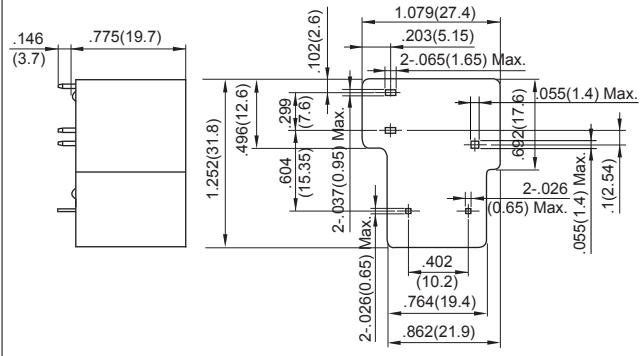
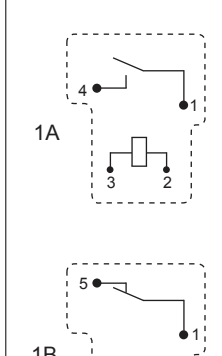
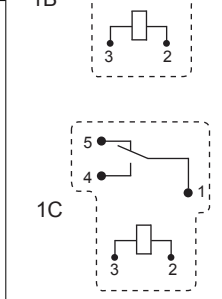
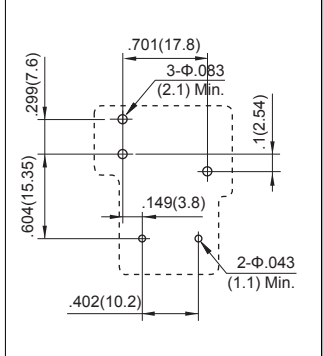
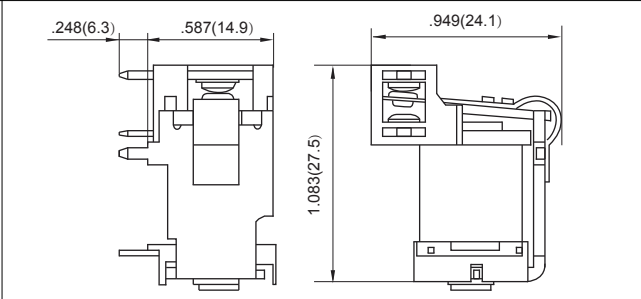
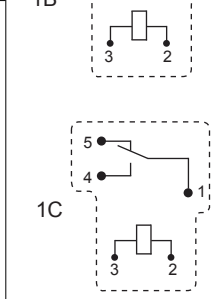
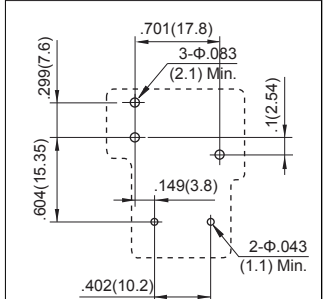
<p>HAT901 Series (with Pin 6)</p>		<p>1A</p>  <p>1B</p> 	
<p>HAT901 Series (with Pin 6) Open Type</p>		<p>1C</p> 	
<p>HAT901 Series (without Pin 6)</p>		<p>1A</p>  <p>1B</p> 	
<p>HAT901 Series (without Pin 6) Open Type</p>		<p>1C</p> 	
<p>Unless otherwise specified tolerances are:</p>			
<p>≤1mm</p>	<p>> 1mm and ≤5mm</p>	<p>> 5mm</p>	
<p>±0.2mm</p>	<p>±0.3mm</p>	<p>±0.4mm</p>	<p>* The tolerance without indicating for PCB layout is always ±0.1mm.</p>

This datasheet is for customers' reference. All the specifications are subject to change without notice.

CHARACTERISTIC CURVES

MAXIMUM SWITCHING POWER

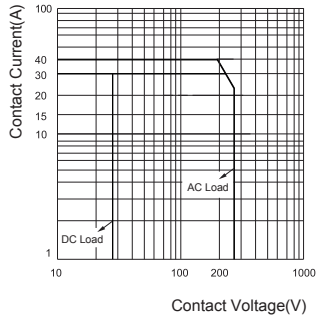

ENDURANCE CURVE

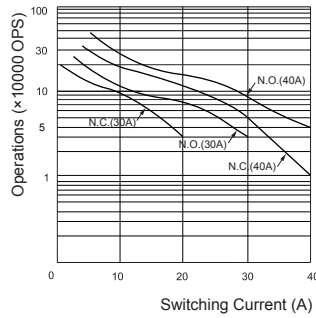

COIL TEMPERATURE RISE

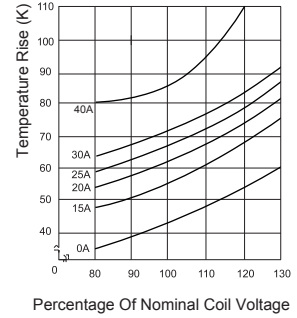

OPERATE TIME / RELEASE TIME

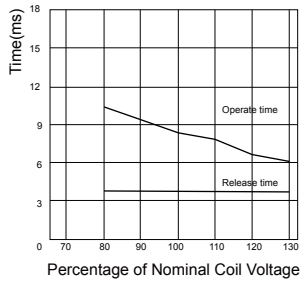

PACKAGING SPECIFICATION

TUBE	OUTER CARTON	OUTER CARTON SIZE
20PCS	500PCS	L590mm*W205mm*H175mm

This datasheet is for customers' reference. All the specifications are subject to change without notice.

APPLICATION GUIDELINES

Automatic Soldering

- * Flow solder is the optimum method for soldering.
- * Adjust the level of solder so that it does not overflow onto the top of the PC board.
- * Unless otherwise specified, solder under the following conditions depending on the type of relay.

Preheat time 20°C-100°C	Rising slope 20°C-120°C	Decreasing slope Peak-150°C	Welding temperature 255°C-265°C
90±5 seconds	< 3°C/s	< 4°C/s	3~5s

Hand Soldering

- * Keep the tip of the soldering iron clean.

Solder Iron	30W or 60W
Iron Tip Temperature	Approx. 350°C 662°F
Solder Time	Within approx. 3 seconds

- * Immediate air cooling is recommended to prevent deterioration of the relay and surrounding parts due to soldering heat.
- * Although the sealed type relay can be cleaned, avoid immersing the relay into cold liquid (such as washing solvent) immediately after soldering. Doing so may deteriorate the sealing performance.

Discard the dropped product

This datasheet is for customers' reference. All the specifications are subject to change without notice.