



MODEL: Fusion 4

P/N: F04E-0101

PRODUCT SPECIFICATION

Version 1.8

REVISION HISTORY

Version #	Implemented By	Revision Date	Approved By	Approval Date	Reason
1.0	Alan Dragon	October 6, 2010	Mark Hamblin	October 6, 2010	Rev 1.0 Release
1.1	Alan Dragon	October 7, 2010	Mark Hamblin	October 7, 2010	Update Reliability and Testing
1.2	Alan Dragon	October 21, 2010	Mark Hamblin	October 21, 2010	Define signals on touch panel connector
1.3	Chris Graham	May 25, 2011	Mark Hamblin	April 4, 2012	Updated DWG / Doc Cosmetic Changes
1.4	Chris Graham	August 25, 2011	Mark Hamblin	April 4, 2012	Updated Fusion Specifications
1.5	Chris Graham	April 4, 2012	Mark Hamblin	April 4, 2012	Updated Drawing
2.0	Peter Mora	Jun 21, 2013	Matt Rosenthal	July 11, 2013	Touch controller change

Touch Revolution is committed to continuous improvement of its product designs and performance. This specification is therefore subject to change without notice. Please contact a customer support representative to insure that you have the most current specification. Products are not intended for use in safety-critical or military/aerospace applications, and customer is responsible for all legal and regulatory requirements associated with use in such applications.

While this specification is intended to assist customers in identifying an appropriate product for their intended application, it does not constitute a warranty that the product is suitable for any specific use. It is the customer's responsibility to determine that the product is suitable for its intended application

(c) Copyright 2013
 TPK America LLC
 All Rights Reserved

Table of Contents

1 INTRODUCTION	1
2 TOUCH MODULE	1
2.1 General Specifications.....	1
2.2 Electrical – Touch Panel.....	2
2.3 Environmental.....	3
2.4 Optical Performance	4
2.5 Mechanical Specifications	4
2.6 FPC Specification	5
3 COMMUNICATIONS INTERFACE	6
3.1 Introduction.....	6
3.2 I2C interface	6
3.3 USB Interface	6
3.4 Switching between I2C and USB.....	7
3.5 Touch Panel Connector	7
3.6 Signal Definitions.....	8
4 LCD INTERFACE.....	9
4.1 Introduction.....	9
4.1.1 LCD Model.....	9
4.2 Features	9
4.3 General Specifications.....	9
4.3.1 Optical Performance	10
4.4 Absolute Maximum Ratings.....	14
4.5 LCD Electrical Characteristics	14
4.5.1 Recommended Operating Conditions.....	14
4.5.2 Backlight Electrical Characteristics	15
4.5.1 LCD Signal Cable Definition	16
4.6 Power On/Off Sequence.....	17
4.6.1 LCD and Backlight Power ON Sequence	17
4.6.2 LCD and Backlight Power Off Sequence	17
4.7 LCD Timing interface requirements	18
4.7.1 Interface Timing Chart	18
4.7.2 Data Input Timing Parameter Setting.....	18
4.7.3 Input Setup Timing Diagram	19
5 RELIABILITY AND TESTING	21
5.1 Reliability Test Specifications	21

5.2	Packaging Specifications.....	21
6	BARCODE	22
6.1	Description.....	22
6.2	Location.....	22
6.3	Contents	22
7	HANDLING AND PRECAUTIONS.....	23
7.1	Disassembly or Modification	23
7.2	UV Exposure	23
7.3	Cleaning	23
7.4	Static Electricity	23
7.5	Absolute Maximum Ratings.....	23
7.6	Breakage	23
7.7	Input Voltages.....	23
7.8	Static Images.....	24
7.9	Outgassing	24
8	MECHANICAL DRAWINGS.....	25

1 INTRODUCTION

The Fusion 4 is an integrated projected capacitive touch display incorporating a 4.3", 480 x 272 (WQVGA) LCD with a LED backlight. The touch portion of the module consists of a glass sensor optically bonded to 1.1 mm cover glass with an FPC (Flexible Printed Circuit) attached for communicating with the touch panel. The touch panel assembly (sensor plus cover glass) is bonded to the LCD frame.

Interfacing to the touch panel is done through an I2C or USB protocol communicating with the touch controller incorporated onto the FPC. The touch panel can provide accurate and responsive touch performance capable of sensing up to two unambiguous points. The integrated configuration of the Fusion touch display gives the end customer the ability to develop a touch user interface with a minimum of time and design effort that is instantly recognizable by the greater public.

2 TOUCH MODULE

2.1 GENERAL SPECIFICATIONS

Table 1 - Touch Performance Specification

Parameter		Value	Unit	Remarks
Linearity	Center	1	mm	Note 1, Appendix A
	Within 5mm of the edge	2		
Touch Sensor Resolution		480x272	Detectable Resolution	
Report Rate	Single Touch	80	Serviced Interrupts/second	Note 2, Appendix A
	Dual Touch	55		
Minimum Touch Diameter		5	mm	Note 4, Appendix A
Minimum Detectable Separation		15	mm	
Number of unique detectable concurrent touches		2		

2.2 ELECTRICAL – TOUCH PANEL

When using the I2C interface these voltages and current are applicable.

Table 2 – I2C Electrical Specification

Parameter	Symbol	Value			Unit
		Min.	Typ.	Max	
Supply voltage	VCC	3.0	3.3	3.47	V
Current (no touch)	ICC	0.08	1.5	12.4	mA

When using the USB interface these voltages and current are applicable.

Table 3 – USB Electrical Specification

Parameter	Symbol	Value			Unit
		Min.	Typ.	Max	
Supply voltage	VCC	3.15	3.3	3.45	V
Current (no touch)	ICC	TBD	TBD	TBD	mA
USB VBUS Voltage	VBUS	4.85	5.0	5.15	V
USB VBUS current	Ivbus	TBD	TBD	500	mA

2.3 ENVIRONMENTAL

Table 4 - Environmental Specification

Parameter	Value	Unit
Operating Temperature	-20 to +60	°C
Storage Temperature	-30 to +70	°C

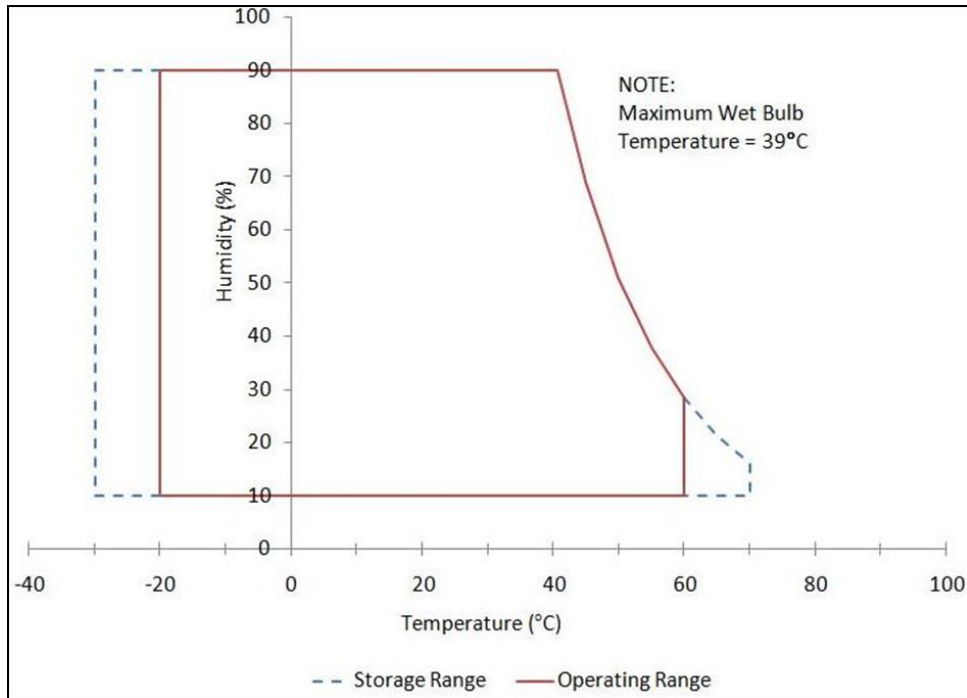

Figure 1 - Operating Temperature and Humidity Range

2.4 OPTICAL PERFORMANCE

Table 5 - Optical Performance Specification

Parameter		Value		Unit	Remarks
Optical Transmittance of Touch Panel		>89		%	Note 5, Appendix A
Light Output without touch panel		Min.=250	Typ.=300	cd/m ²	Center of the Panel
Light Output with Touch Panel		Min.=220	Typ.=265	cd/m ²	Center of the Panel
Viewing Angle	Hor.	θ_R	Min.=65	Typ.=75	Deg.
		θ_L	Min.=65	Typ.=75	
	Vert.	Φ_T	Min.=50	Typ.=60	Deg.
		Φ_D	Min.=60	Typ.=70	
Note 6, Appendix A					

2.5 MECHANICAL SPECIFICATIONS

Table 6 - Mechanical Specification

Parameter	Value	Unit	Remarks
Outline Dimension	117.50 x 79.20 x 5.23	mm	
Active Area	95.04(H) x 53.86 (V)	mm	LCD, Touch Sensor
Weight	80.2 (Typ)	g	
First Surface Hardness	>9H	Pencil Hardness	See Note 7, Appendix A

2.6 FPC SPECIFICATION

The flexible segment (any portion without a stiffener) of the signal FPC from the touch panel has a minimum bend radius $> 1.0\text{mm}$. The image below shows the FPC with the stiff areas outlined in red. Stiff areas are not designed to be bent or deformed.

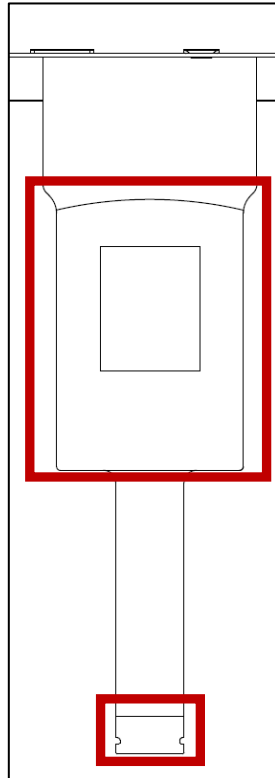

Figure 2 – Close-up View FPC Stiffener Areas (Shown from Rear View of Touch Panel Module)

3 COMMUNICATIONS INTERFACE

3.1 INTRODUCTION

The Fusion 4 Touch Module has 2 interfaces to communicate data to the host. The 2 interfaces are I2C or USB.

3.2 I2C INTERFACE

The I2C interface of the touch module is a NXP compliant I2C interface (V2.1).

The Fusion 4 Touch module uses an Atmel MaxTouch Touch controller integrated circuit. Touch Revolution provides reference drivers for developers to use when designing systems to communicate with the Fusion 4. For detailed information about the Touch controller please check directly with Atmel. TR is not able to distribute detailed information about Atmel touch controller without a 3-Way NDA.

The reference drivers are available from the Touch Revolution webpage or by contacting support@touchrev.com.

The Touch module uses 0x4A or 0x4B as its 7 bit I2C slave address.

The I2C interface has 3.3K Ohm resistors pulling the SDA and SCL lines up to VCC (3.3V).

3.3 USB INTERFACE

The Fusion 4 USB interface adheres to the Device Class Definition for Human Interface Devices (HID) version 1.11. The module reports as a Digitizer. It is compliant to the Windows 7 Digitizer Driver Specification¹. The Fusion 4 is compatible to USB 2.0 FS device standards.

The Fusion 4 USB device vendor ID and product ID definition are as follows:

USB VID is: 0x1391, the PID is: 0x2112

The Fusion 4 maximum width in pixels is 4096.

The Fusion 4 maximum height in pixels is 4096.

The Fusion 4 maximum number of touches is 2.

¹ The Full Windows 7 Digitizer Driver Specification can be found online at - http://www.microsoft.com/whdc/device/input/DigitizerDrvs_touch.mspx

In addition to the basic digitizer function the Fusion 4 USB interface also supports a vendor command function that can be used to configure and control the touch panel. The definition of these functions can be found in ***Fusion USB Touch Configuration Controls*** document. The basic functionality includes the ability to reset the touch panel controller, perform specific i2c transfers, and perform touch firmware upgrades.

3.4 SWITCHING BETWEEN I2C AND USB

The touch panel can only communicate via either USB or I2C. It cannot communicate on both interfaces simultaneously.

To communicate via USB the VBUS pin must be connected to +5V. This will deactivate the I2C interface. Using the I2C pins while in USB mode will cause the device to malfunction.

To communicate via I2C the VBUS signal must not be connected. It must be left floating.

3.5 TOUCH PANEL CONNECTOR

The recommended touch panel connector is: FCI P/N SFV10R-1STE1HLF or equivalent. The pinout for the FCI connector is as noted in the following table

Table 7 - Touch Panel Connector Pinout – Refer to Mechanical Drawings for Pin 1 Orientation

Pin No.	Symbol	Description	Required for USB	Required for I2C
1	VCC	Power	Yes	Yes
2	RST	Reset	No	Yes
3	INT	Interrupt	No	Yes
4	SDA	I2C Data	No	Yes
5	SCL	I2C Clock	No	Yes
6	GND	Ground	Yes	Yes
7	D+	USB Positive	Yes	No
8	D-	USB Negative	Yes	No
9	VBUS	USB Power	Yes	NC
10	GND	Ground	Yes	Yes

3.6 SIGNAL DEFINITIONS

- **VCC** 3.3V Power supply for the touch controller (required with and without USB).
- **RST** Reset for the touch controller. Should be connected to a reset line. This reset is asserted low (0V). When not asserted it should be raised to VCC.
- **INT** Interrupt from the touch controller. This should be connected to an interrupt enabled IO. This output is asserted low to ground when touch data is ready. This interrupt should be treated as an edge sensitive signal.
- **SDA** Data line of I2C connection. This signal should be connected to the data line of an I2C bus. This I2C bus should have pull-up resistors to VCC. The touch controller does not contain pull-ups resistors
- **SCL** Clock line of I2C connection. This signal should be connected to the clock line of an I2C bus. This I2C bus should have pull-up resistors to VCC. The touch controller does not contain pull-ups resistors.
- **GND** Digital Ground
- **D+** USB Data +
- **D-** USB Data –
- **VBUS** +5 Volt for USB

4 LCD INTERFACE

4.1 INTRODUCTION

The Fusion 4 incorporates a color active matrix thin film transistor (TFT) liquid crystal display (LCD) that uses amorphous silicon TFT as a switching device. This LCD is composed of a TFT LCD panel, a driving circuit, and LED backlight system. This model has a 4.3" inch diagonally measured active display area with a 480H x 272V (WQVGA) display format that can display 16.2M colors.

4.1.1 LCD Model

Manufacturer - Tianma

Model - TM043NDH02

4.2 FEATURES

- 4.3" inch diagonal configuration
- 480H x 272V (WQVGA) Pixel Format
- 3.3V TTL Interface
- 16.7M colors using an 8 bit R.G.B. signal input

4.3 GENERAL SPECIFICATIONS

Table 8 - LCD Specifications

Parameter	Specifications(LCD Only)	Unit
Screen Size	4.3" (Diagonal)	inch
Display Format	480 RGB(H)X 272(V)	pixels
Pixel Configuration	RGB Vertical Stripe	
Active Area	95.04 (H) x 53.86 (V)	mm
Pixel Pitch	0.198 (H) x 0.198 (V)	mm
Outline Dimension	105.50(W) x 67.20(H) x 2.90(D) Typ.	mm
Backlight	White LED	
Power Consumption	0.074W(Logic)/ 0.640W(Backlight)	Watt
Operating Temperature	-20 ~ 70	°C
Storage Temperature	-30 ~ 80	°C

4.3.1 Optical Performance

Table 9 – LCD Optical Characteristics

Parameter	Symbol	Condition	Min	Typ	Max	Unit	Note
View Angle – Top	θT	CR \geq 10	60	70	-	Degree	Note 2
View Angle – Bottom	θB	CR \geq 10	40	50	-	Degree	Note 2
View Angle – Left	θL	CR \geq 10	60	70	-	Degree	Note 2
View Angle - Right	θR	CR \geq 10	60	70	-	Degree	Note 2
Contrast Ratio	CR	$\Theta=0$	400	500	-		Note 1,3
Response Time – ON	T_{ON}	25 °C	--	20	30	ms	Note 1,4
Response Time - OFF	T_{OFF}	25 °C	--	20	30	ms	Note 1,4
Chromaticity – White - x		BL on	0.265	0.315	0.365		Note 5,1
Chromaticity – White – y		BL on	0.285	0.335	0.385		Note 5,1
Chromaticity – red – x		BL on	0.531	0.581	0.631		Note 5,1
Chromaticity – red – y		BL on	0.295	0.345	0.395		Note 5,1
Chromaticity – green – x		BL on	0.298	0.348	0.395		Note 5,1
Chromaticity – green – y		BL on	0.531	0.581	0.631		Note 5,1
Chromaticity – blue – x		BL on	0.103	0.153	0.203		Note 5,1
Chromaticity – blue - y		BL on	0.045	0.095	0.145		Note 5,1
Uniformity	U		75	80	-	%	Note 1, 6
NTSC			-	50	-	%	Note 5
Luminance	L		250	300	-	cd/m ²	Note 1,7

Test Conditions:

1. $I_F = 20\text{mA}$ (one channel), the ambient temperature is 25. °C

2. The test systems refer to Note 1 and Note 2.

Note 1: Definition of optical measurement system.

The optical characteristics should be measured in dark room. After 5 Minutes operation, the optical properties are measured at the center point of the LCD screen. All input terminals LCD panel must be ground when measuring the center area of the panel.

Figure 3 - Optical characteristic measurement system

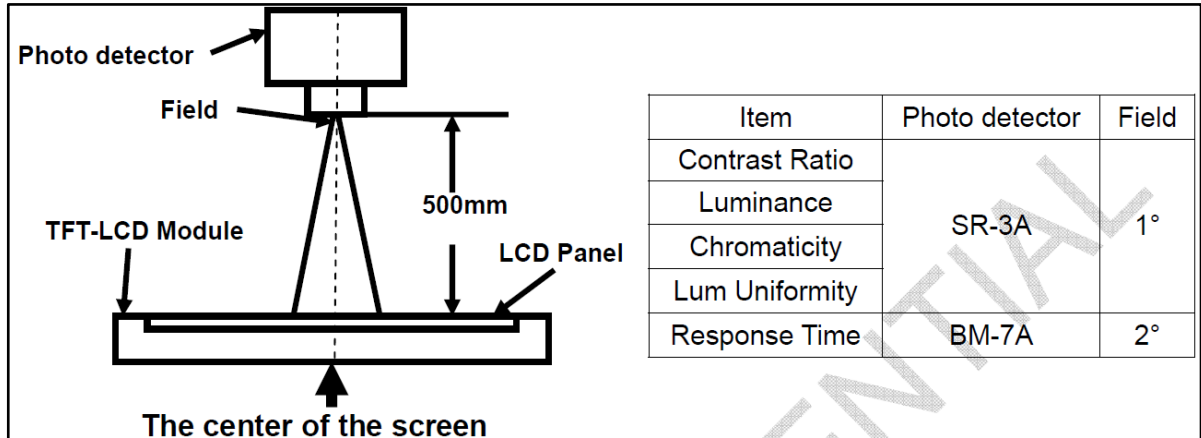

Note 2: Definition of viewing angle range and measurement system. Viewing angle is measured at the center point of the LCD by CONOSCOPE(ergo-80).

Figure 4 - Viewing angle definition

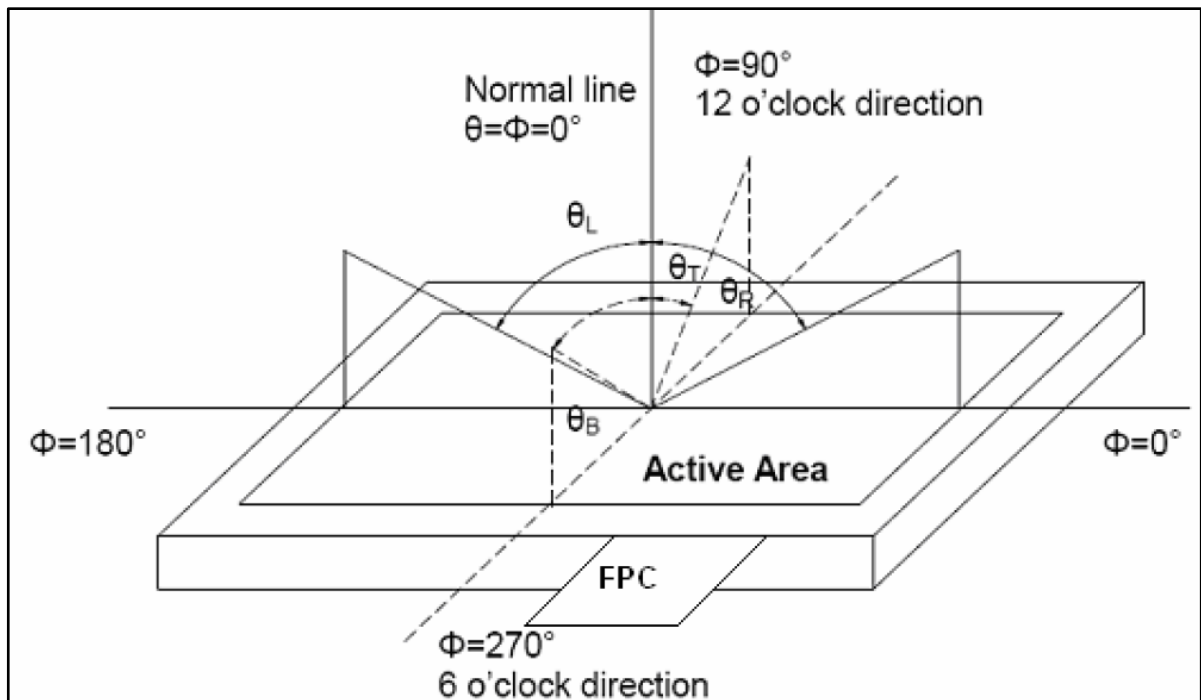

Note 3: Definition of Contrast Ratio

$$\text{Contrast Ratio (CR)} = \frac{\text{Luminance measured when LCD is on the "White" state}}{\text{Luminance measured when LCD is on the "Black" state}}$$

Note 4: Definition of Response time: The response time is defined as the LCD optical switching time interval between “White” state and “Black” state. Rise time (TON) is the time between photo detector output intensity changed from 90% to 10%. And fall time (TOFF) is the time between photo detector output intensity changed from 10% to 90%.

Figure 5 - Response Time definition

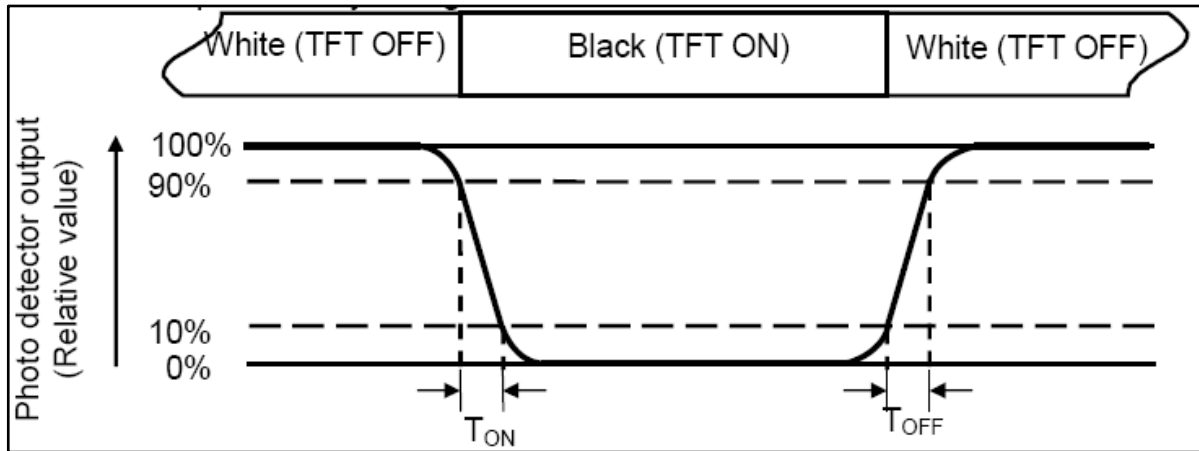

Note 5: Definition of color chromaticity (CIE1931)
Color coordinates measured at center point of LCD.

Note 6: Definition of Luminance Uniformity
Active area is divided into 9 measuring areas (Refer Fig. 2). Every measuring point is placed at the center of each measuring area.

$$\text{Luminance Uniformity (U)} = \text{Lmin} / \text{Lmax}$$

L-----Active area length W----- Active area width

Figure 6 - Luminance measurement location

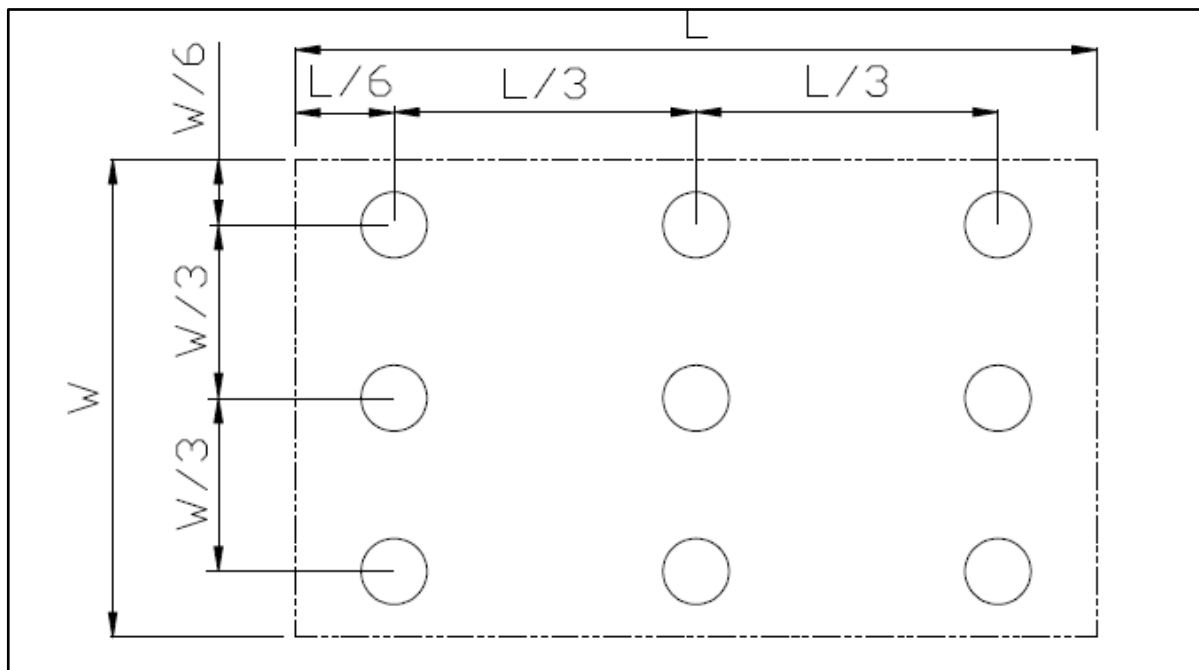

Lmax: The measured Maximum luminance of all measurement position.
Lmin: The measured Minimum luminance of all measurement position.

Note 7: Definition of Luminance:
Measure the luminance of white state at center point.

4.4 ABSOLUTE MAXIMUM RATINGS

Table 10 – LCD and LED Maximum Ratings (GND = 0V)

Parameter	Symbol	Min.	Max.	Unit	Note
Supply Voltage	VDD	-0.3	4.0	V	
Back Light Forward Current	I _{LED}		25	mA	For each LED
Operating Temperature	T _{OPR}	-20	70	°C	
Storage Temperature	T _{STG}	-30	80	°C	

4.5 LCD ELECTRICAL CHARACTERISTICS

4.5.1 Recommended Operating Conditions

Table 11 – LCD Recommended Operating Conditions

Parameter	Symbol	Min.	Typ	Max.	Unit	Note
Supply Voltage	VDD	3.0	3.3	3.6	V	
Input Signal Low Voltage Level	V _{IL}	0	-	0.3xVDD	V	R0~R5, G0~G5, B0~B5, DCLK, DISP, HSYNC, VSYNC, DE
Input Signal High Voltage Level	V _{IH}	0.7xVDD	-	VDD	V	
Output Signal Low Voltage Level	V _{OL}	--	--	0.2xVDD	V	
Output Signal High Voltage Level	V _{OH}	0.8xVDD	--	VDD	V	
Power consumption – Black Mode			74		mW	
Power Consumption – Standby Mode			50		uW	Note 1

Note 1: To test the current dissipation, use “all Black Pattern”.

4.5.2 Backlight Electrical Characteristics

Table 12 – Backlight Electrical Characteristics (Ta=25°C)

Parameter	Symbol	Min.	Typ.	Max.	Unit	Note
Channel	Ichannel	-	20.0	25.0	mA	Note 1
Forward Voltage	VBL	-	16	-	V	
Backlight Power Consumption	WBL	-	640	-	mW	
Life Time	--	10,000	20,000	-	Hrs	Note 3

Note 1: Each LED : IF =20 mA, VF =3.2V.

Note 2: Optical performance should be evaluated at Ta=25°C only.

Note 3: If LED is driven by high current, high ambient temperature & humidity condition. The life time of LED will be reduced. Operating life means brightness goes down to 50% initial brightness. Typical operating life time is estimated data.

4.5.1 LCD Signal Cable Definition

Table 13 - LCD Signal Definition

Pin No.	Symbol	I/O	Description	Pin No.	Symbol	I/O	Description
1	VLED-	P	Power for LED Backlight Cathode	21	B0	I	Blue Data (LSB)
2	VLED+	P	Power for LED Backlight Anode	22	B1	I	Blue Data
3	GND	P	Power Ground	23	B2	I	No Connection
4	VDD	P	Power Voltage	24	B3	I	Blue Data
5	R0	I	Red Data (LSB)	25	B4	I	Blue Data
6	R1	I	Red Data	26	B5	I	Blue Data
7	R2	I	Red Data	27	B6	I	Blue Data
8	R3	I	Red Data	28	B7	I	Blue Data (MSB)
9	R4	I	Red Data	29	GND	P	Power Ground
10	R5	I	Red Data	30	DCLK	I	Pixel Clock
11	R6	I	Red Data	31	DISP	I	Display On/Off
12	R7	I	Red Data (MSB)	32	HSYNC	I	Horizontal Sync
13	G0	I	Green Data (LSB)	33	VSYNC	I	Vertical Sync
14	G1	I	Green Data	34	DE	I	Data Enable
15	G2	I	Green Data	35	NC	-	No Connect
16	G3	I	Green Data	36	GND	P	Power Ground
17	G4	I	Green Data	37	NC	I/O	No Connect
18	G5	I	Green Data	38	NC	I/O	No Connect
19	G6	I	Green Data	39	NC	I/O	No Connect
20	G7	I	Green Data (MSB)	40	NC	IO	No Connect

4.5.1.1 LCD Signal Mating Connector

Use Hirose FPC connector, **FH19SC-40S-0.5SH** or equivalent.

4.6 POWER ON/OFF SEQUENCE

4.6.1 LCD and Backlight Power ON Sequence

Figure 7 - LCD and Backlight Power on sequence

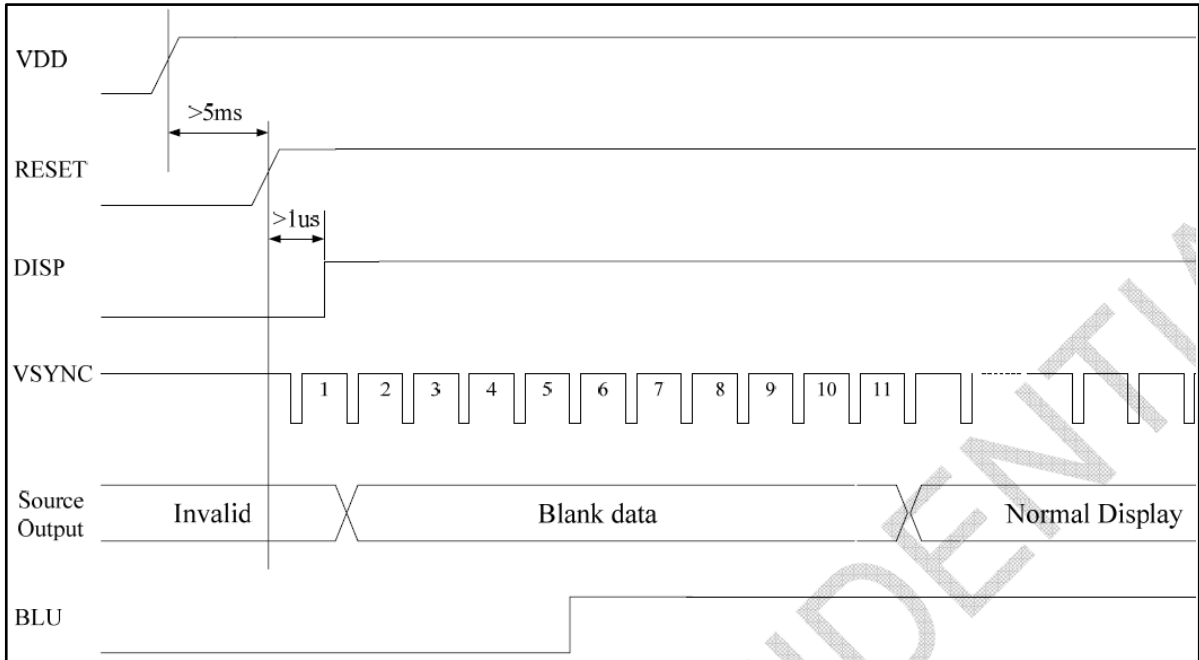

4.6.2 LCD and Backlight Power Off Sequence

Figure 8 - LCD and Backlight Power off sequence

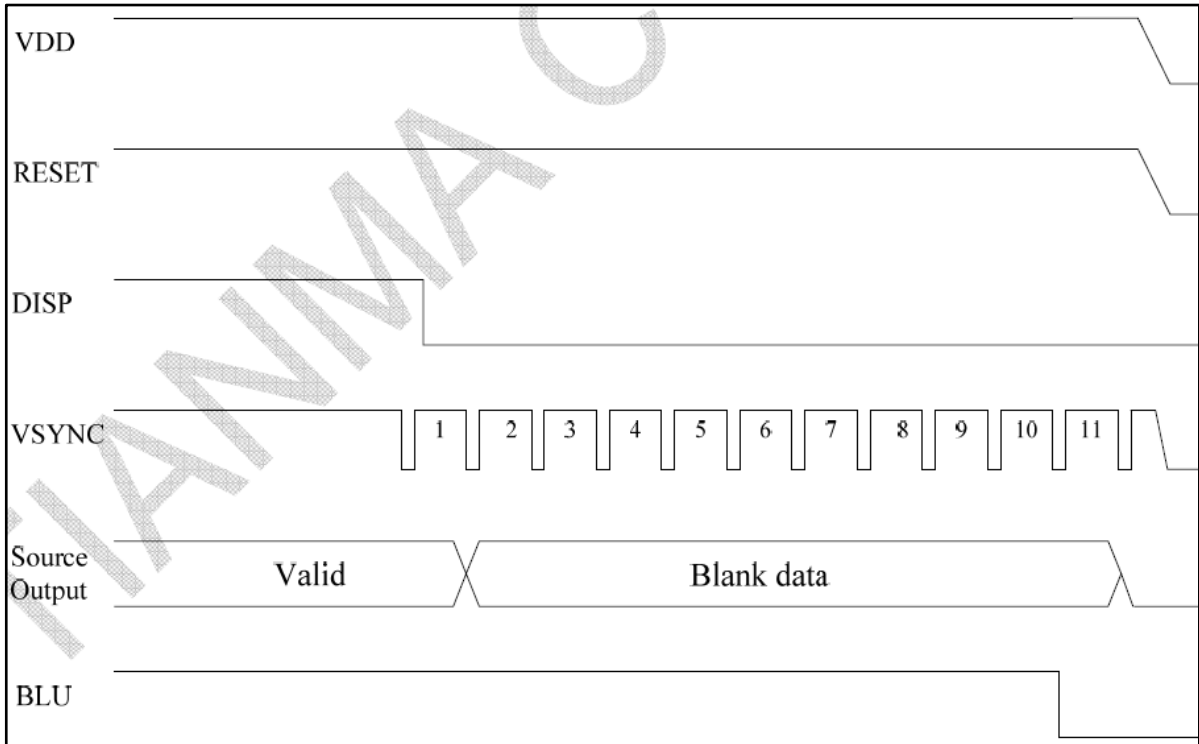

4.7 LCD TIMING INTERFACE REQUIREMENTS

4.7.1 Interface Timing Chart

Table 14 – LCD Interface Timing

Parameter	Symbol	Min.	Typ.	Max.	Unit
DCLK Cycle Time	T_{pw}	66.7	-	-	ns
DCLK Pulse High Width	T_{pwh}	26.7	-	-	ns
DCLK Pulse Low Width	T_{pwl}	26.7	-	-	ns
DE Setup Time	T_{des}	10	-	-	ns
DE Hold Time	T_{deh}	10	-	-	ns
HSYNC Setup Time	T_{hs}	10	-	-	ns
HSYNC Hold Time	T_{hh}	10	-	-	ns
VSYNC Setup Time	T_{vhs}	10	-	-	ns
VSYNC Hold Time	T_{vhh}	10	-	-	ns
Data Setup Time	T_{ds}	10	-	-	ns
Data Hold Time	T_{dh}	10	-	-	ns
DISP Setup Time	T_{diss}	10	-	-	ns
DISP Hold Time	T_{dish}	10	-	-	ns

Note 1: $t_r=t_f=2ns$. t_r , t_f is defined 10% to 90% of signal amplitude.

Note 2: For parallel interface, maximum clock frequency is 15MHz.

4.7.2 Data Input Timing Parameter Setting

Figure 9 - Timing parameters

Parameter	Symbol	Min.	Typ.	Max.	Unit
DCLK frequency	Fclk	-	9	15	MHz
HSYNC frequency	$1/t_h$	-	17.14	-	KHz
VSYNC frequency	t/t_v	-	59.94	-	Hz
Horizontal Cycle	t_h	525	525	605	DCLK
Horizontal Display Period	t_{hd}	480	480	480	DCLK
Horizontal pulse width	t_{hp}	2	41	41	DCLK
Horizontal back porch	t_{hb}	2	2	41	DCLK
Horizontal front porch	t_{hf}	2	2	82	DCLK
Vertical cycle	t_v	285	286	399	HSYNC
Vertical display period	t_{vd}	272	272	272	HSYNC

Vertical pulse width	t_{vp}	1	10	11	HSYNC
Vertical back porch	t_{vb}	1	2	11	HSYNC
Vertical front porch	t_{vf}	1	2	227	HSYNC

Note 1 : Unit: CLK=1/ fCLK , H= th,

Note 2 : It is necessary to keep $t_{vp}+t_{vb}=12$ and $t_{hp}+t_{hb}= 43$ in sync mode. DE mode is unnecessary to keep it.

4.7.3 Input Setup Timing Diagram

Figure 10 - Timing Diagram

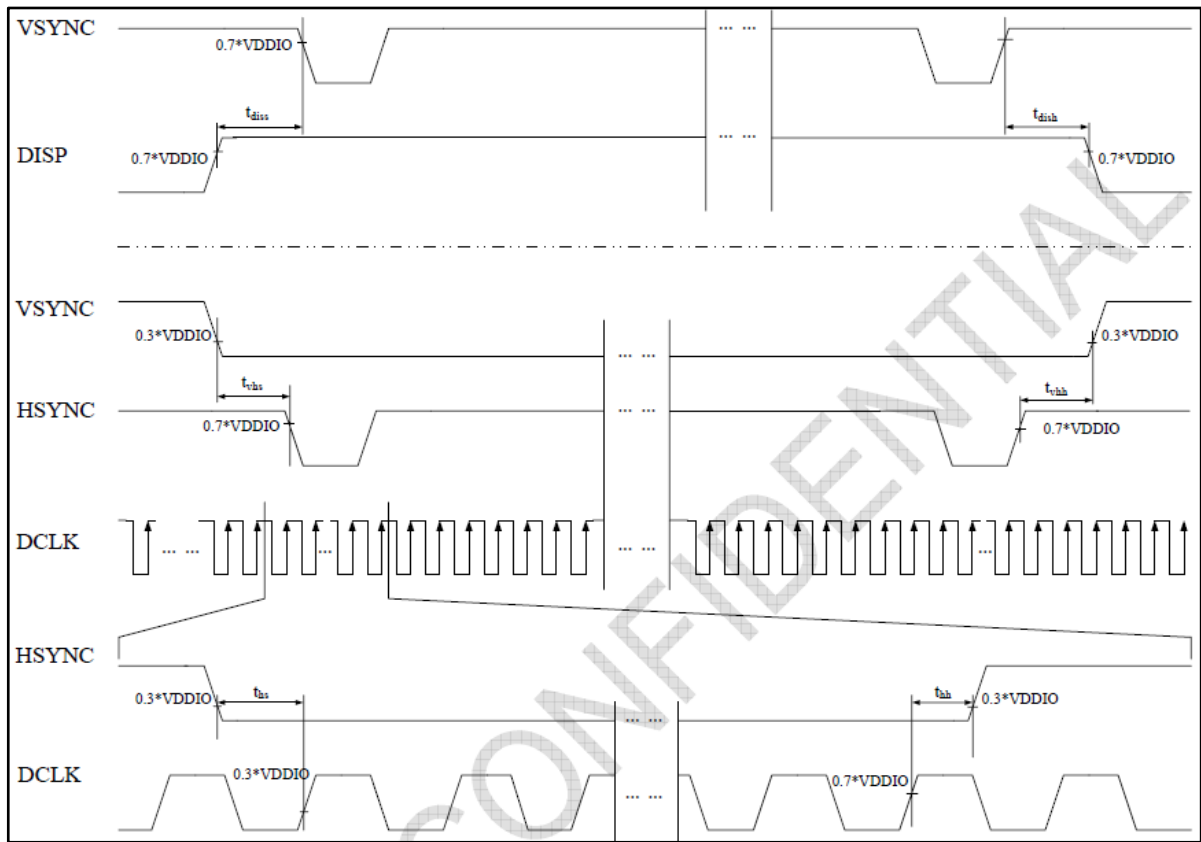
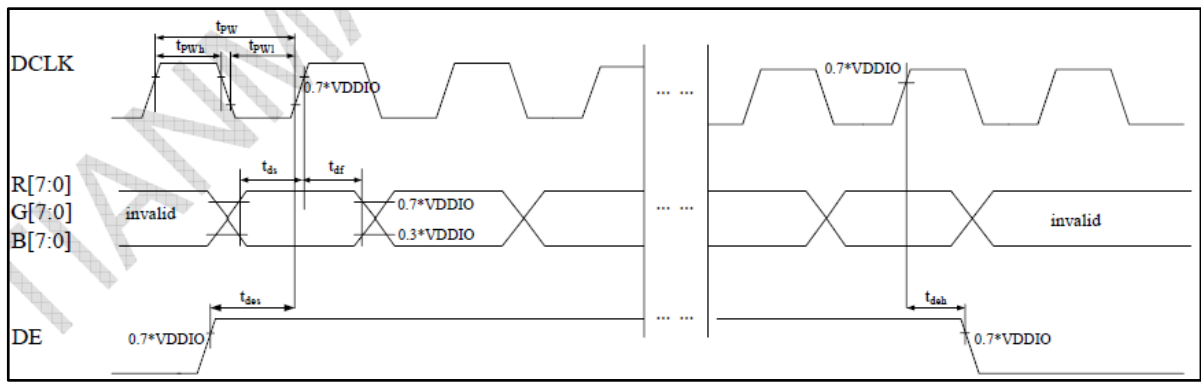

Figure 11 - Timing Diagram 2



5 RELIABILITY AND TESTING

5.1 RELIABILITY TEST SPECIFICATIONS

Table 15 – Reliability Test Specifications

Item	Condition
High Temperature Storage	T _A = +70°C, 240 hrs
Low Temperature Storage	T _A = -30°C, 240 hrs
High Temperature Operation	T _A = +60°C, 240 hrs
Low Temperature Operation	T _A = -20°C, 240 hrs
Thermal cycling	-20°C (30 min) ⇄ +60°C (30 Min), 100 cycles (DRY)
Electrostatic discharge	±8kV (Contact) / ±10kV (air)

5.2 PACKAGING SPECIFICATIONS

Table 16 – Packaging Specifications

Item	Condition
Drop Test	<ol style="list-style-type: none"> 1) Drop Sequence: 1 corner, 3 edges, 6 surfaces. 2) Drop height according to the weight of the package. 3) Inspection: sampling check, check each layer of upper and lower, 2 layers in center, total 4 layers.
Non-Operating Random Vibration	<ol style="list-style-type: none"> 1) Truck Spectrum: (0.52G rms) and Air Spectrum: (PSD=1.46G rms), 3 axis (X/Y/Z), 20 min per axis per test. 2) Inspection: sampling check, check each layer of upper and lower, 2 layers in center, total 4 layers.

Note: All packaging tests are performed on 1 complete box of Fusion Touch Modules.

6 BARCODE

6.1 DESCRIPTION

Every Fusion touch panel contains a unique 2 dimensional barcode. This barcode is used for serial number identification and part specification.

6.2 LOCATION

The barcode is located on the flex tail as pictured below.

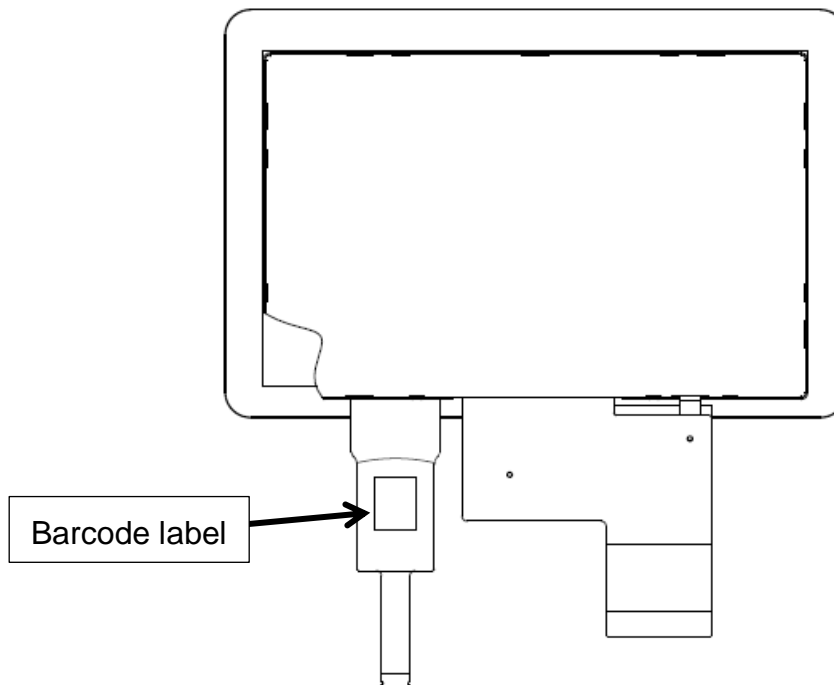

Figure 12 – Barcode Label Area (Rear View of Module Shown)

6.3 CONTENTS

The barcode contains the unit serial number, Touch Revolution part number, and touch firmware release version.

7 HANDLING AND PRECAUTIONS

7.1 DISASSEMBLY OR MODIFICATION

Do not disassemble or modify the touch display. This may cause damage to sensitive components and may cause dust or scratches between the touch sensor and LCD. Touch Revolution's warranty will be void if the unit has been disassembled or modified.

7.2 UV EXPOSURE

Long term exposure to sunlight can affect the optical performance of the LCD.

7.3 CLEANING

The cover glass should be cleaned using a soft, lint free cloth. It is recommended that either an ammonia based glass cleaner (e.g. Windex) or a 50:50 solution of isopropyl alcohol and water be used for cleaning the sensor. Apply the cleaning solution to the cloth and gently wipe the surface of the sensor. To help minimize streaking, wipe in a circular motion starting in the center and working outwards.

7.4 STATIC ELECTRICITY

Since the LCD and Touch panel use CMOS ICs, the device is susceptible to electrostatic discharge. Please use appropriate grounding when handling these modules.

7.5 ABSOLUTE MAXIMUM RATINGS

Do not exceed the absolute maximum rating values for the supply voltages and environmental conditions to prevent damage to the touch display.

7.6 BREAKAGE

If the LCD panel breaks be careful not to touch any liquid crystal material that may spill. Immediately rinse with water if liquid crystal material comes in contact with skin.

7.7 INPUT VOLTAGES

Turn off the power supply before handling and/or inserting signal or power cables to the touch module.

7.8 STATIC IMAGES

If fixed images are displayed for a long period of time, an afterimage is likely to occur.

7.9 OUTGASSING

Do not store or use the touch module in an environment where caustic materials such as reagents, solvents, adhesives, and resins are present. Outgassing of these materials can damage the polarizer and ACF connections.

8 MECHANICAL DRAWINGS

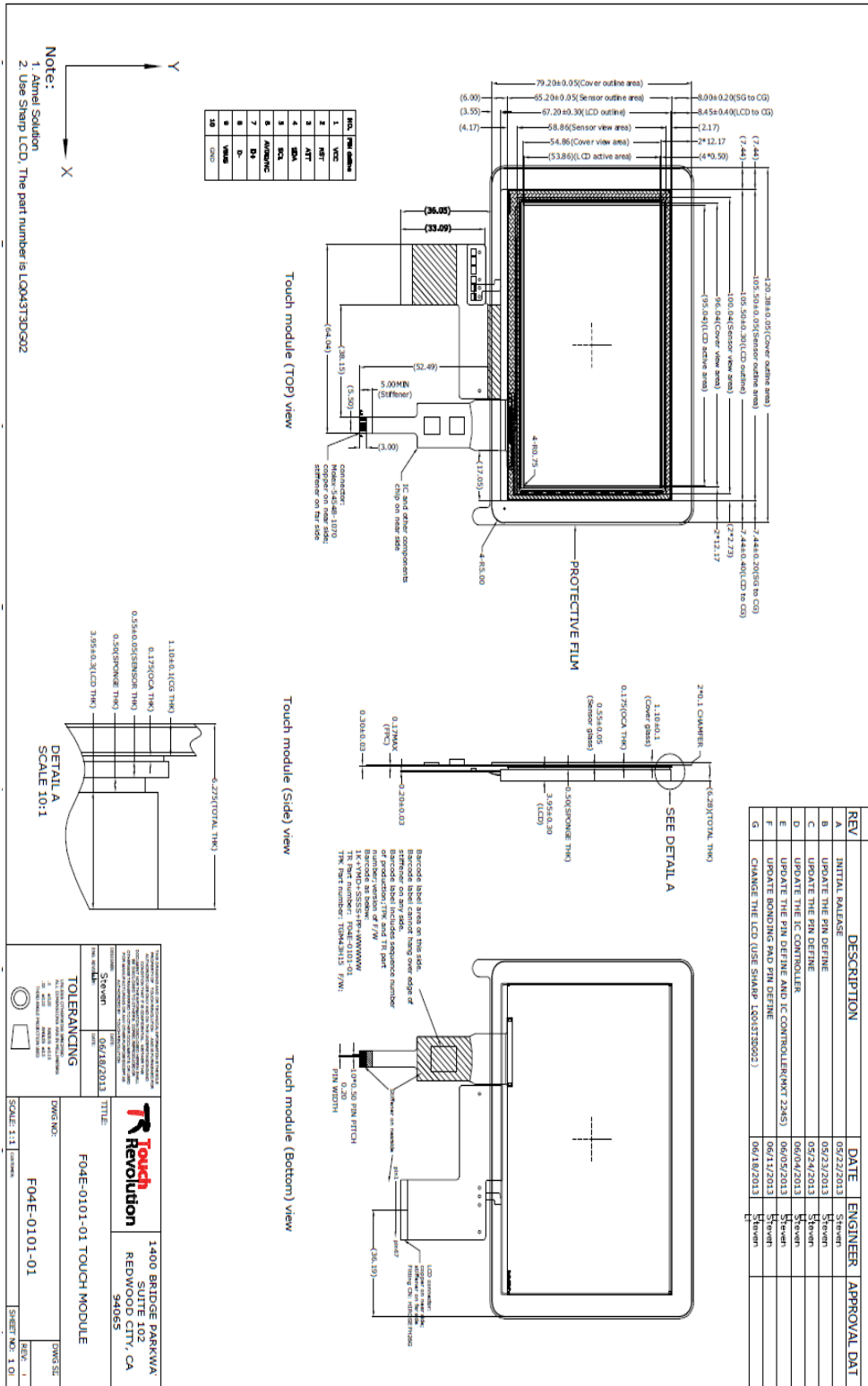

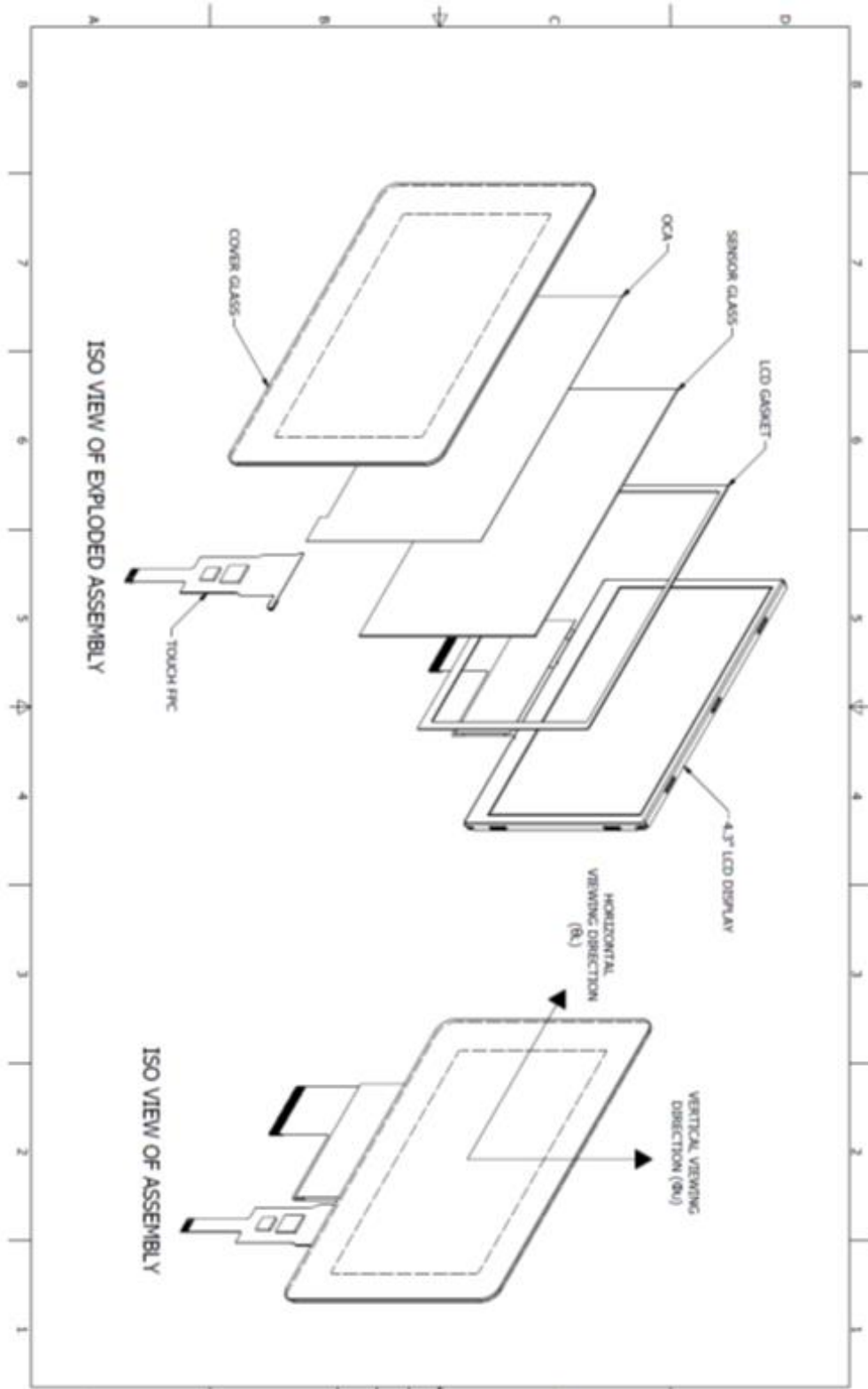

APPENDIX A

Note 1: Linearity Test Definition

The linearity of the sensor is tested by dragging a 6mm copper slug in a line across the first surface of the touch sensor. The distance between the actual location of the center of the slug and the reported location shall be less than or equal to the maximum specified error.

Note 2: Report Rate

Report rate is the maximum rate at which touch data is returned to the host PC. The report rate may drop to 30 interrupts/second for some unique two finger touch combinations.

Note 3: Response Time

Response time is the time elapsed between the first touch and interrupt assuming touch is in active mode

Note 4: Minimum Touch Diameter

The minimum touch diameter is the minimum diameter of a copper slug that is needed to record a touch.

Note 5: Optical Transmittance

Measured Per ASTM D1003

Note 6: Viewing Angle

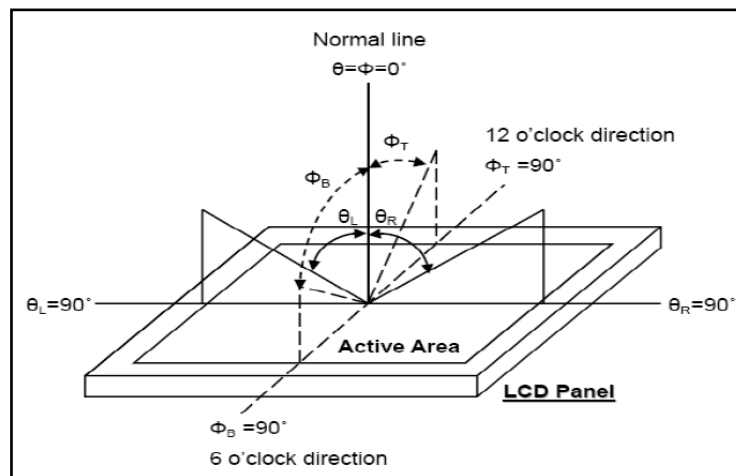

Note 7: First Surface Hardness

Measured Per ASTM D3363