



1200V Half-Bridge Silicon Carbide Power Module

GE12160CEA3

V_{DS} : 1200 V I_{DS} : 1425 A

Superior performance for high power, high frequency applications needing best-in-class power density



Features

- Highly reliable GE SiC MOSFET devices AEC-Q101 qualified to 200°C
- Low $R_{DS(ON)}$ (1.0 mΩ) (device only)
- Low stray inductance (3 nH)
- Ultra-low switching losses over entire operating range
- GE Power Overlay wire-bondless technology
- Body diode with minimal reverse recovery
- Integrated temperature sensing
- Dedicated DESAT Pin and Source-Kelvin Pin
- AlSiC Baseplate and Si_3N_4 AMB Substrate

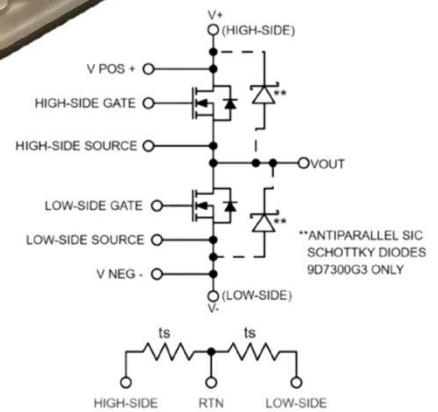

MOSFET DC Characteristics @ $T_J = 25^\circ\text{C}$ (unless otherwise specified)

Symbols	Parameters	Min.	Typ.	Max.	Unit	Test Conditions	Notes
I_{DS}	Continuous Drain Current			1425		$V_{GS} = 20\text{ V}, T_c = 25^\circ\text{C}$	Per Switch
				999	A	$V_{GS} = 20\text{ V}, T_c = 100^\circ\text{C}$	
				816		$V_{GS} = 20\text{ V}, T_c = 125^\circ\text{C}$	
$I_{DS,pulse}$	Pulsed Drain Current			2850	A	$T_c = 25^\circ\text{C}, t_p = 1\text{ ms}$	
V_{DSmax}	Drain - Source Breakdown Voltage	1200			V	$V_{GS} = 0\text{ V}, I_{DS} = 100\ \mu\text{A}$	
V_{GSmax}	Maximum Gate - Source Voltage			-15/+23	V	$V_{DS} = 0\text{ V}$	
V_{GSop}	Recommended Gate - Source Voltage		-5/+20		V		
T_{Jmax}	Junction Temperature			175	$^\circ\text{C}$		
T_c	Case Temperature Range	-55		150	$^\circ\text{C}$		
T_{STG}	Storage Temperature Range	-55		150	$^\circ\text{C}$		
P_D	Power Dissipation			3750	W	$T_c = 25^\circ\text{C}$	Per Switch



(Continued) **MOSFET DC Characteristics @ $T_J = 25^\circ\text{C}$** (unless otherwise specified)

Symbols	Parameters	Min.	Typ.	Max.	Unit	Test Conditions	Notes
I_{DS}	Continuous Drain Current			1425	A	$V_{GS} = 20\text{ V}, T_c = 25^\circ\text{C}$	Per Switch
$V_{GS(th)}$	Gate Threshold Voltage	2.5	2.8	4.5	V	$V_{GS} = V_{DS}, I_{DS} = 480\text{ mA}$	
I_{DSS}	Drain Leakage Current			0.3 4.8	mA	$V_{DS} = 1200\text{ V}, V_{GS} = 0\text{ V}, T_J = 25^\circ\text{C}$ $T_J = 200^\circ\text{C}$	
I_{GSS}	Gate-Source Leakage Current			480	nA	$V_{GS} = -15/+23\text{ V}$	
$R_{DS(on)}$	On State Resistance (Device Only)		1.0 1.9	1.5 2.3	m Ω	$V_{GS} = 20\text{ V}, I_{DS} = 475\text{ A}, T_J = 25^\circ\text{C}$ $T_J = 175^\circ\text{C}$	Per Switch
$R_{G(int)}$	Gate-Source series resistance		0.90		Ω	$V_{GS} = 0\text{ V}, f = 100\text{ kHz}, T_c = 25^\circ\text{C}$	

MOSFET Dynamic Characteristics per switch @ $T_J = 25^\circ\text{C}$ (unless otherwise specified)

Symbols	Parameters	Min.	Typ.	Max.	Unit	Test Conditions	Notes
C_{iss}	Input Capacitance		90		nF		
C_{oss}	Output Capacitance		8.5		nF	$V_{GS} = 0\text{ V}$ $V_{DS} = 600\text{ V}$	
C_{rss}	Reverse Transfer Capacitance		0.25		nF	$f = 100\text{ kHz}$	
E_{on}	Turn-On Switching Energy		82		mJ	$V_{GS} = 0\text{ V to } +20\text{ V}$	
E_{off}	Turn-Off Switching Energy		85		mJ	$V_{DS} = 600\text{ V}$ $I_{DS} = 1600\text{ A}$	
t_r	Rise Time		195		ns	$R_{Gon} = 2.2\ \Omega$	
t_f	Fall Time		78		ns	$R_{Goff} = 1.5\ \Omega$	
Q_G	Total Gate Charge		3744		nC	$V_{GS} = 0\text{ to } 18\text{ V}$	
Q_{GD}	Gate-Drain Charge		1608		nC	$V_{DS} = 900\text{ V}$	
Q_{GS}	Gate-Source Charge		528		nC	$I_{DS} = 720\text{ A}$	

Body Diode Characteristics per switch @ $T_J = 25^\circ\text{C}$ (unless otherwise specified)

Symbols	Parameters	Min.	Typ.	Max.	Unit	Test Conditions	Notes
I_{SD}	Pulsed body diode current			2160	A	$V_{GS} = 0\text{ V}$	1.
V_{SD}	Diode Forward Voltage		4.69		V	$V_{GS} = 0\text{ V}, I_{SD} = 1425\text{ A}, T_J = 25^\circ\text{C}$	

1. Use of body diode is recommended in pulse mode only

Thermal Characteristics

Symbols	Parameters	Min.	Typ.	Max.	Unit	Test Conditions	Notes
R_{th}	Thermal Resistance Junction-to-Case		0.03	0.04	$^\circ\text{C/W}$	JESD51-14	Per Switch



Temperature Sensor Characteristics

Symbols	Parameters	Min.	Typ.	Max.	Unit	Test Conditions	Notes
R_{RTD}	Rated Resistance of RTD		1k		ohm		2.
	Tolerance of Resistance		0.12		%		
	Accuracy		0.3		°C		
	Measuring Current	100		300	μA		
TCR	Temperature Coefficient		3850		ppm/K		
	Operating Temperature	-70		+500	°C		
	Insulation Resistance		100		Mohm	20°C	

2. RTD is mounted directly over center-most die allowing direct reading of T_J

Module packaging data

Symbols	Parameters	Min.	Typ.	Max.	Unit	Test Conditions	Notes
V_{Iso}	Case Isolation Voltage	3			kV	AC 50 Hz, 1 min, 25°C	
CTI	Comparative Tracking Index		600				
M_s	Mounting Torque			4.0	N-m	Power Terminals	
				2.5		Baseplate	
L_{D1S2}	Loop Inductance		3		nH		
	Module Mass		0.46		Kg		
	Clearance Distance		7		mm	V+ to V-	
			60		mm	V- to V_{OUT}	
			25		mm	V+ to Baseplate	
			25		mm	V_{OUT} to Baseplate	
	Creepage Distance		7		mm	V+ to V-	
			60		mm	V- to V_{OUT}	
			30		mm	V+ to Baseplate	
			30		mm	V_{OUT} to Baseplate	
M_{BP}	Base Plate Material		AlSiC				



Typical performance: **GE12160CEA3**

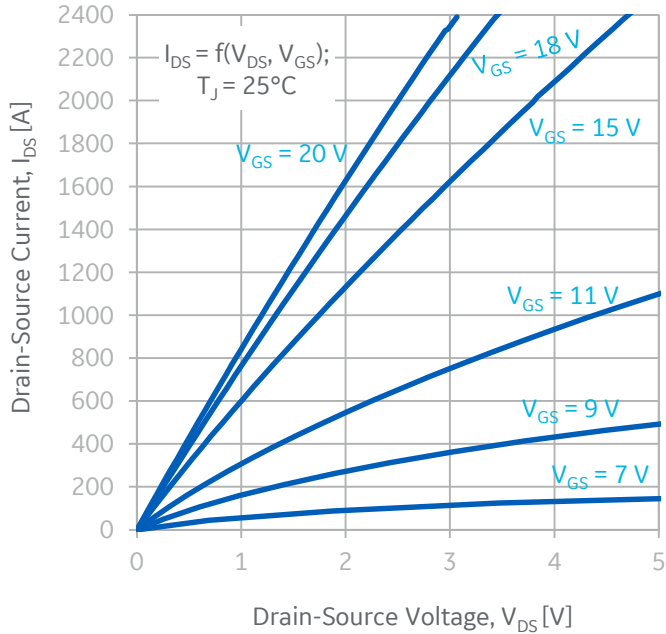

Figure 1: Output Characteristics (25°C)

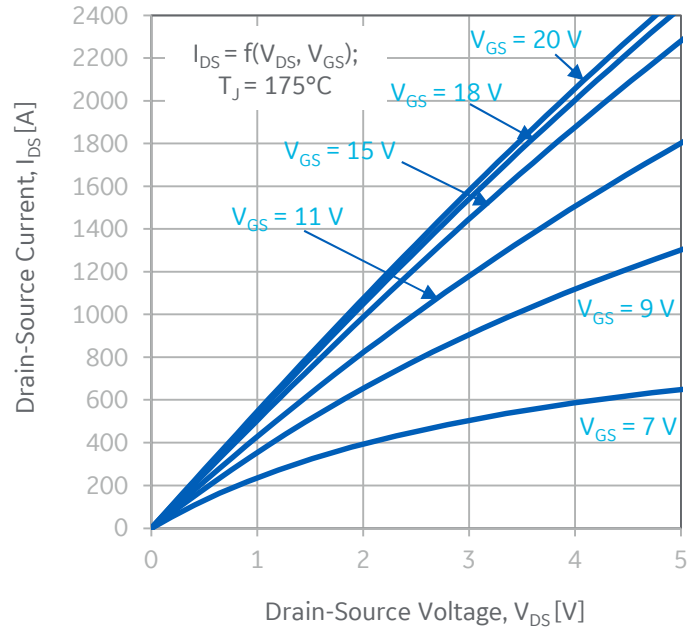

Figure 2: Output Characteristics (175°C)

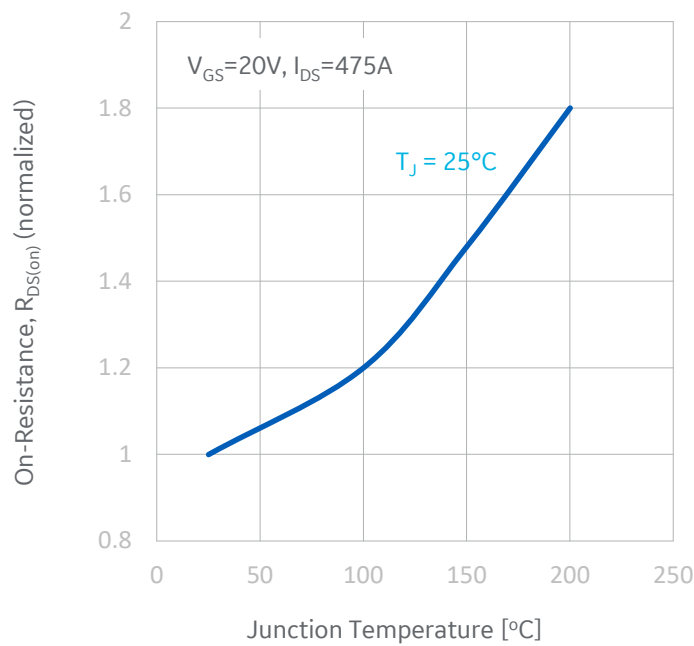

Figure 3: Normalized On-state Resistance vs. Temperature

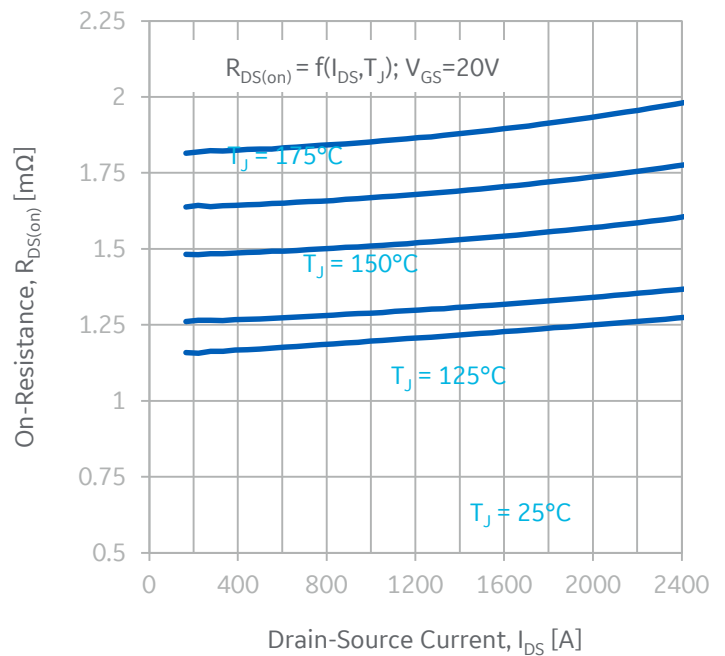

Figure 4: Module Drain-Source On-state Resistance



Typical performance: **GE12160CEA3**

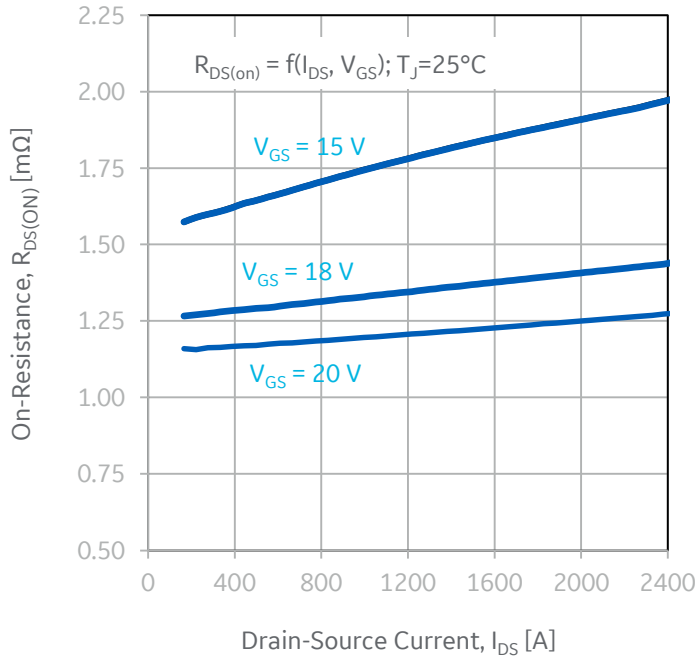

Figure 5: Module Drain-Source On-state Resistance

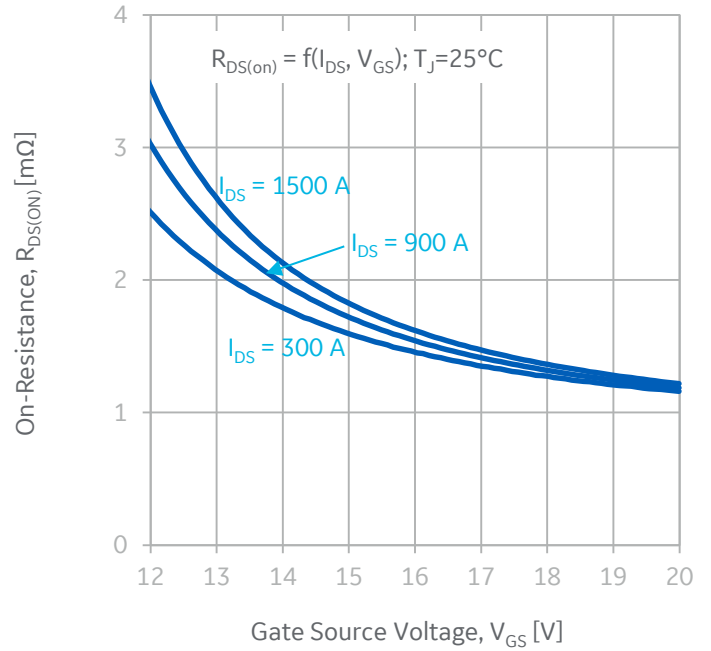

Figure 6: Drain-Source On-state Resistance vs. Gate Voltage

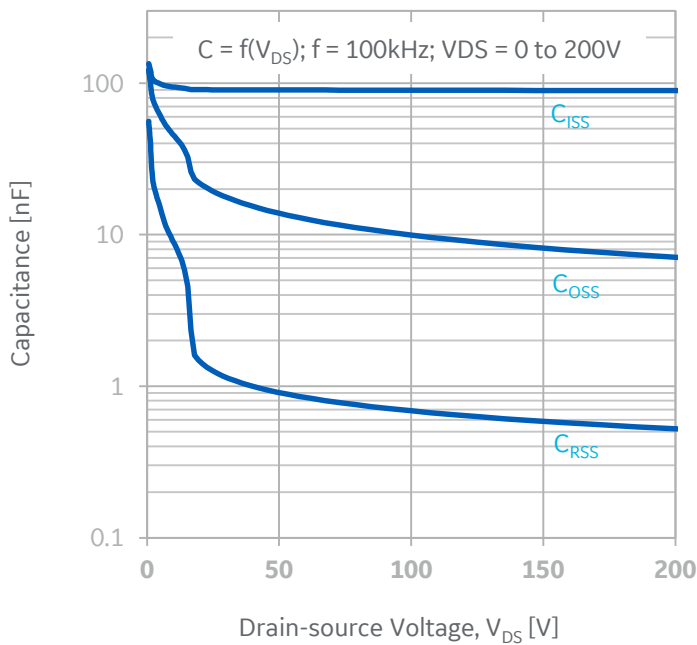

Figure 7: Junction Capacitances to 200 V

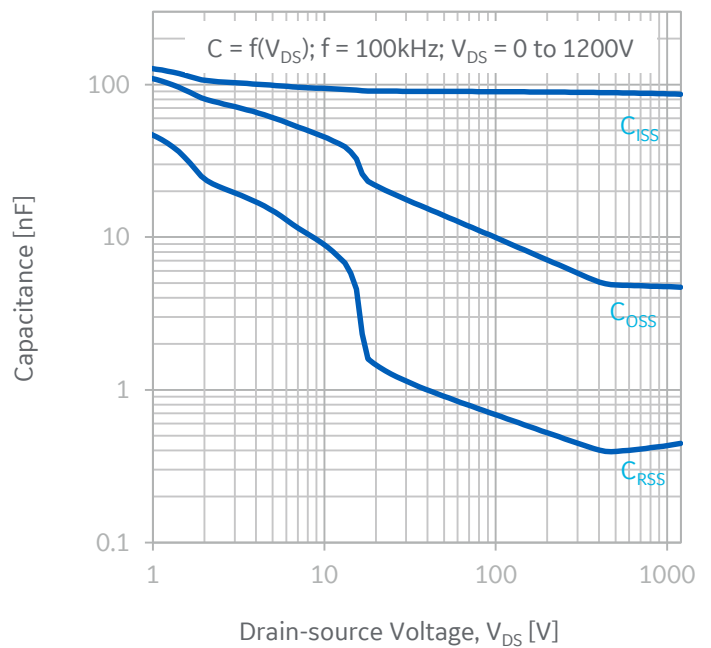

Figure 8: Junction Capacitances to 1200 V



Typical performance: **GE12160CEA3**

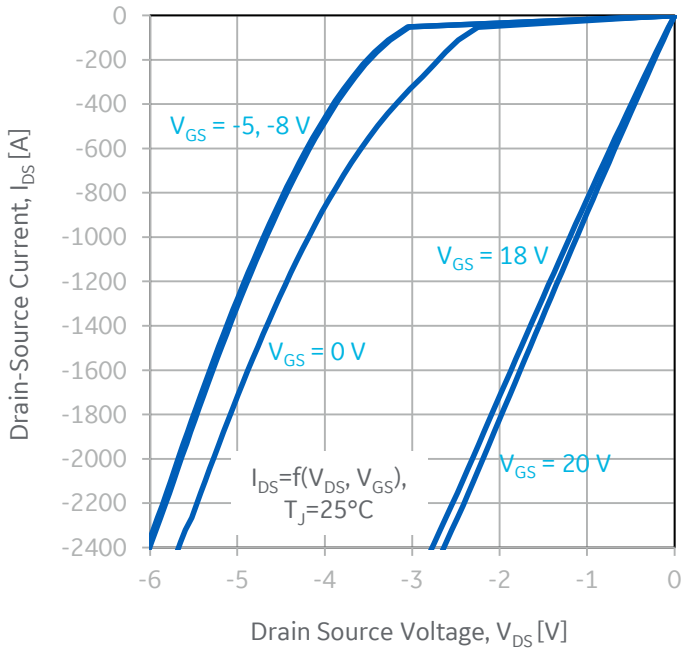

Figure 9: 3rd Quadrant Characteristics (25°C)

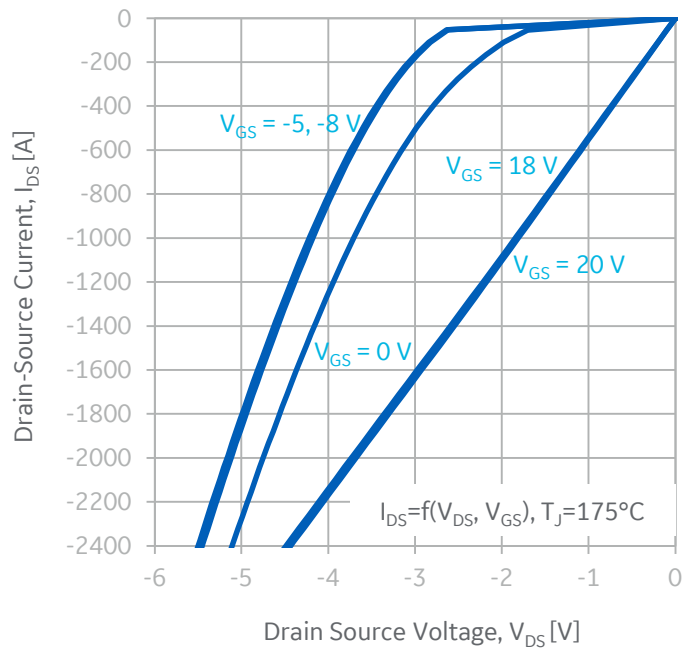

Figure 10: 3rd Quadrant Characteristics (175°C)

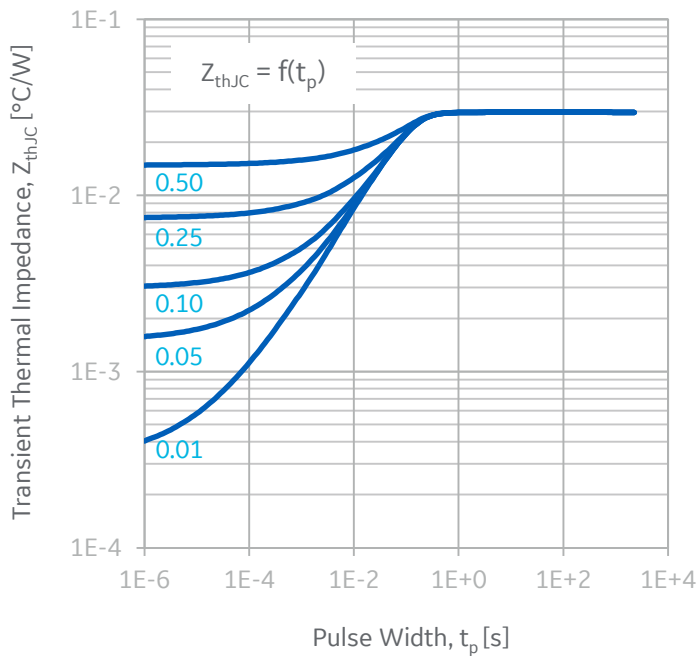

Figure 11: Transient Thermal Impedance

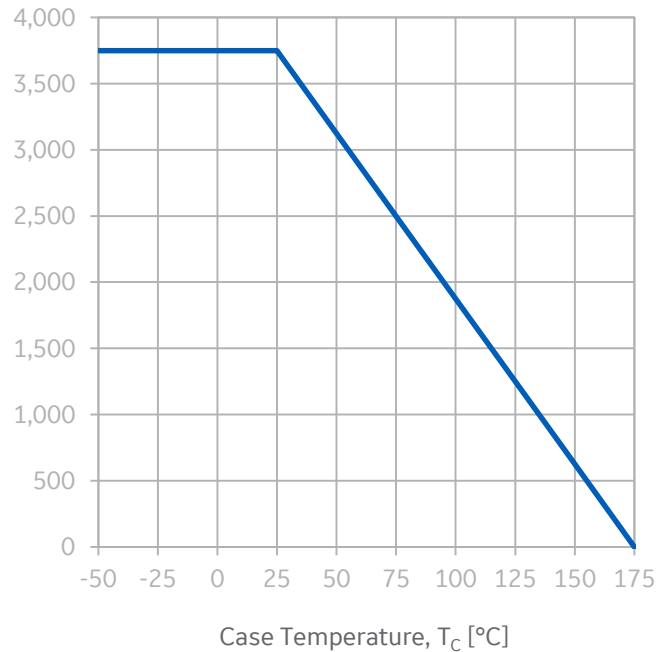
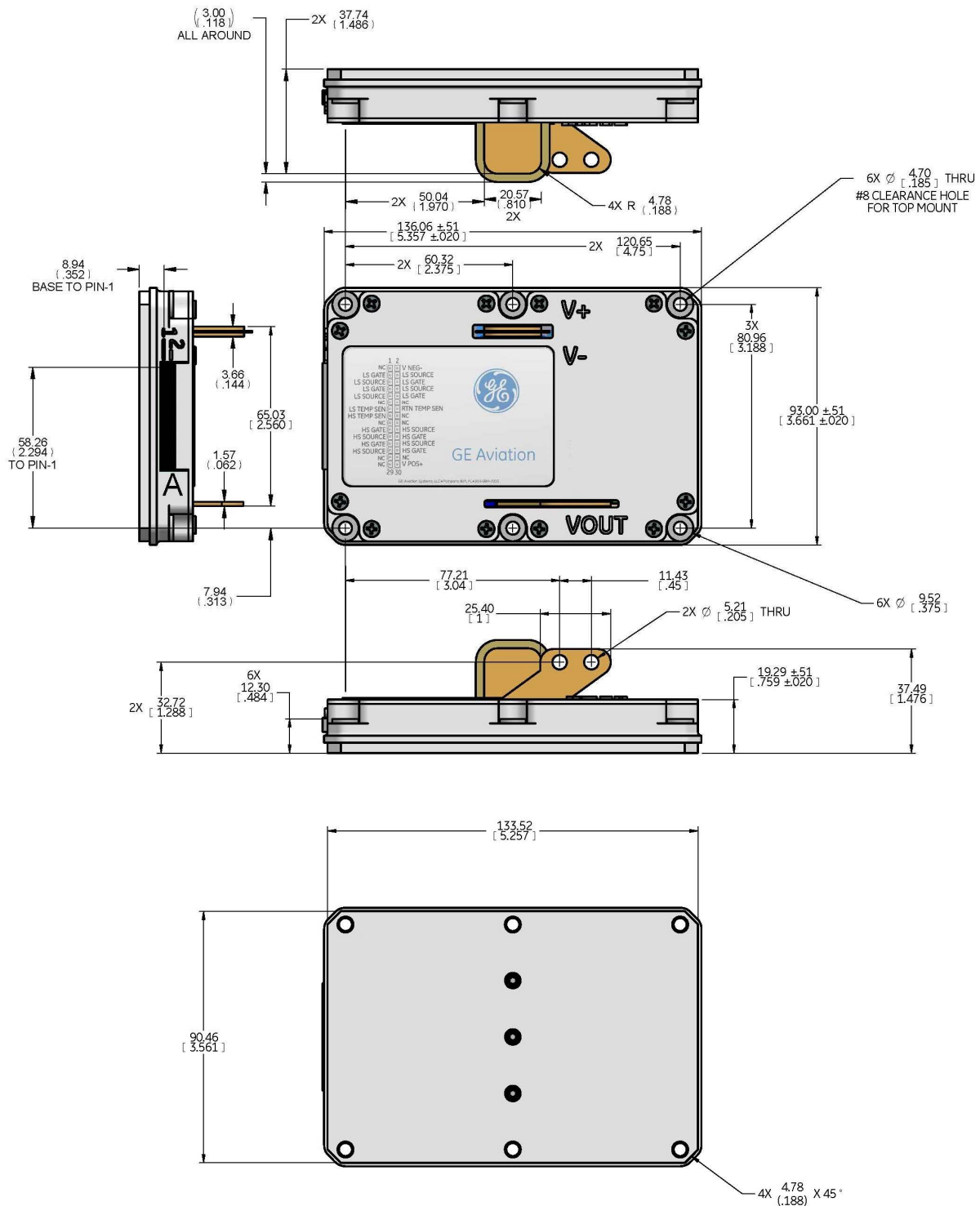

Figure 12: Maximum Power Dissipation vs. Case Temperature



Module dimensions (millimeters)





Electrical interface outline drawing

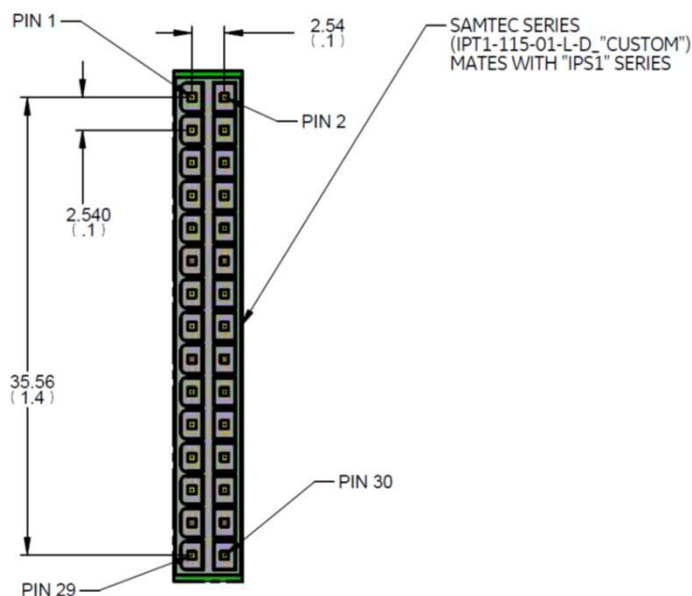

Interconnect

1	**
2	V NEG (-)
3	LOW-SIDE GATE
4	LOW-SIDE SOURCE
5	LOW-SIDE SOURCE
6	LOW-SIDE GATE
7	LOW-SIDE GATE
8	LOW-SIDE SOURCE
9	LOW-SIDE SOURCE
10	LOW-SIDE GATE
11	**
12	**
13	LOW-SIDE TEMP SENSE
14	RTN TEMP SENSE
15	HIGH-SIDE TEMP SENSE
16	**
17	**
18	**
19	HIGH-SIDE GATE
20	HIGH-SIDE SOURCE
21	HIGH-SIDE SOURCE
22	HIGH-SIDE GATE
23	HIGH-SIDE GATE
24	HIGH-SIDE SOURCE
25	HIGH-SIDE SOURCE
26	HIGH-SIDE GATE
27	**
28	**
29	**
30	V POS (+)

** = No Connection

Disclaimer

The data presented in this document are for informational purposes only and shall in no event be regarded as a guarantee of conditions or characteristics. Any warranty or license for this product shall be specified and governed by the terms of a separate purchase agreement. General Electric Company does not assume any liability arising out of the application or use of this product; neither does it convey any license under its patent rights, nor the rights of others.

General Electric Company reserves the right to make changes in specifications and features shown herein to improve reliability, function, or design, or discontinue this product, at any time without notice or obligation. Contact your GE representative for the most current information.

Warning

This product is not authorized for use (1) in life support systems or (2) for applications implanted into the human body, without the express written approval of General Electric Company.

Questions or need help designing in GE SiC Power modules? Please contact:

SiC.Products@ge.com

GE Aerospace
2705 Gateway Dr.
Pompano Beach, FL 33069
(954) 984-2400

Document revisions

Rev. 1 - Public Release - October 2022